

The right choice for the ultimate yield!

LS ELECTRIC strives to maximize your profits in gratitude for choosing us as your partner.

Programmable Logic Control

XGB Main unit(XBM-S, XBC-H Type)

XGT Series

User Manual

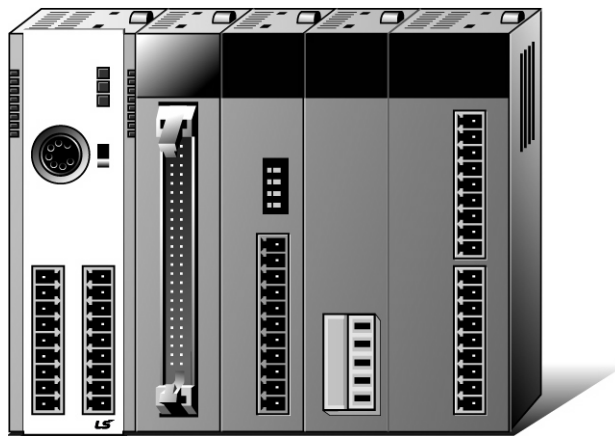

XBM-DR16S
XBM-DN16S
XBM-DN32S
XBC-DR32H
XBC-DN32H
XBC-DR64H
XBC-DN64H
XBC-DR32HL
XBC-DN32H/DC
XBC-DN64H/DC
XBC-DR32H/DC
XBC-DR64H/DC



Safety Instructions

- Read this manual carefully before installing, wiring, operating, servicing or inspecting this equipment.
- Keep this manual within easy reach for quick reference.

LSELECTRIC

Before using the product ...

For your safety and effective operation, please read the safety instructions thoroughly before using the product.



- ▶ Safety Instructions should always be observed in order to prevent accident or risk with the safe and proper use the product.
- ▶ Instructions are separated into “Warning” and “Caution”, and the meaning of the terms is as follows;



This symbol indicates the possibility of serious injury or death if some applicable instruction is violated



This symbol indicates the possibility of slight injury or damage to products if some applicable instruction is violated

- ▶ The marks displayed on the product and in the user’s manual have the following meanings.
 -  Be careful! Danger may be expected.
 -  Be careful! Electric shock may occur.
- ▶ The user’s manual even after read shall be kept available and accessible to any user of the product.

Safety Instructions when designing

Warning

- ▶ **Please, install protection circuit on the exterior of PLC to protect the whole control system from any error in external power or PLC module.** Any abnormal output or operation may cause serious problem in safety of the whole system.
 - Install applicable protection unit on the exterior of PLC to protect the system from physical damage such as emergent stop switch, protection circuit, the upper/lowest limit switch, forward/reverse operation interlock circuit, etc.
 - If any system error (watch-dog timer error, module installation error, etc.) is detected during CPU operation in PLC, the whole output is designed to be turned off and stopped for system safety. However, in case CPU error if caused on output device itself such as relay or TR can not be detected, the output may be kept on, which may cause serious problems. Thus, you are recommended to install an addition circuit to monitor the output status.

- ▶ **Never connect the overload than rated to the output module nor allow the output circuit to have a short circuit,** which may cause a fire.

- ▶ **Never let the external power of the output circuit be designed to be On earlier than PLC power,** which may cause abnormal output or operation.

- ▶ **In case of data exchange between computer or other external equipment and PLC through communication or any operation of PLC (e.g. operation mode change), please install interlock in the sequence program to protect the system from any error.** If not, it may cause abnormal output or operation.

Safety Instructions when designing

Caution

- ▶ **I/O signal or communication line shall be wired at least 100mm away from a high-voltage cable or power line.** If not, it may cause abnormal output or operation.

Safety Instructions when designing

Caution

- ▶ **Use PLC only in the environment specified in PLC manual or general standard of data sheet.** If not, electric shock, fire, abnormal operation of the product or flames may be caused.
- ▶ **Before installing the module, be sure PLC power is off.** If not, electric shock or damage on the product may be caused.
- ▶ **Be sure that each module of PLC is correctly secured.** If the product is installed loosely or incorrectly, abnormal operation, error or dropping may be caused.
- ▶ **Be sure that I/O or extension connector is correctly secured.** If not, electric shock, fire or abnormal operation may be caused.
- ▶ **If lots of vibration is expected in the installation environment, don't let PLC directly vibrated.** Electric shock, fire or abnormal operation may be caused.
- ▶ **Don't let any metallic foreign materials inside the product,** which may cause electric shock, fire or abnormal operation..

Safety Instructions when wiring

Warning

- ▶ **Prior to wiring, be sure that power of PLC and external power is turned off.** If not, electric shock or damage on the product may be caused.
- ▶ **Before PLC system is powered on, be sure that all the covers of the terminal are securely closed.** If not, electric shock may be caused

Caution

- ▶ **Let the wiring installed correctly after checking the voltage rated of each product and the arrangement of terminals.** If not, fire, electric shock or abnormal operation may be caused.
- ▶ **Secure the screws of terminals tightly with specified torque when wiring.** If the screws of terminals get loose, short circuit, fire or abnormal operation may be caused.
- *
 - ▶ **Surely use the ground wire of Class 3 for FG terminals, which is exclusively used for PLC.** If the terminals not grounded correctly, abnormal operation may be caused.
 - ▶ **Don't let any foreign materials such as wiring waste inside the module while wiring,** which may cause fire, damage on the product or abnormal operation.

Safety Instructions for test-operation or repair

Warning

- ▶ **Don't touch the terminal when powered.** Electric shock or abnormal operation may occur.
- ▶ **Prior to cleaning or tightening the terminal screws, let all the external power off including PLC power.** If not, electric shock or abnormal operation may occur.
- ▶ **Don't let the battery recharged, disassembled, heated, short or soldered.** Heat, explosion or ignition may cause injuries or fire.

Caution

- ▶ **Don't remove PCB from the module case nor remodel the module.** Fire, electric shock or abnormal operation may occur.
- ▶ **Prior to installing or disassembling the module, let all the external power off including PLC power.** If not, electric shock or abnormal operation may occur.
- ▶ **Keep any wireless installations or cell phone at least 30cm away from PLC.** If not, abnormal operation may be caused.

Safety Instructions for waste disposal

Caution

- ▶ **Product or battery waste shall be processed as industrial waste.** The waste may discharge toxic materials or explode itself.

Revision History

Version	Date	Remark	Page
V 1.0	2006.6	1. First Edition	-
V 1.1	2007.7	1. Position and Special function contents separated (1) Position function contents separated (position part published) (2) PID control and Ch. 12 Analog IO module contents separated	- - -
		2. Contents added	
		(1) Naming standard added	2-3 ~ 2-6
		(2) Caution when selecting IO module added	7-1 ~ 7-6
		(3) IO wiring method by using Smart Link board added	7-27 ~ 7-28
		(4) Installation and wiring contents added	10-1 ~ 10-18
		3. Content modified	
		(1) Safety instruction modified	1 ~ 6
		(2) System Configuration modified	2-7 ~ 2-10
		(3) High speed counter function modified	8-6 ~ 8-8
		(4) External dimension modified	App. 2-1 ~ 2-4
V 1.2	2008.3	1. XGB compact type 'H' type added	-
		2. Built-in communication content separated	Ch. 9
		(1) Ch.9 built-in communication function separated (Cnet I/F user manual)	
V1.3	2009.3	1. Specification of output for positioning added	7-13,14,17,18
V1.6	2010.3	1. "UL warranty voltage" word added	4-6
		2. RTC example program modified	6-22
		3. XBC input resistor modified and digital I/O mixed module added	Chapter 7
		4. Installation of module added	9-10
		5. DC power unit added	Front cover
		6. DC power unit and expansion module added	2-1 ~ 2-4
		7. DC power unit and expansion module added	4-6 ~ 4-7
		8. DC power unit and expansion module added	Chapter 7
		9. DC power unit and expansion module added	Appendix 2
		10. Error in high speed counter channel fixed	8-3
		11. Specification of TR output for positioning modified	7-13, 14, 17, 18
		12. Error in figure fixed	4-4
		13. External memory module added	Ch6.13
		14. XGB compact type model added	Front cover

Version	Date	Remark	Page
		15. 'S', 'H' type max. I/O point modified	2-1 ~ 2-4
		16. 'S', 'H' type max. I/O point modified	4-1 ~ 4-2
V1.7	2014.3	1. Data Back-up method added	4-11
		2. Module added	
		(1) XBE-DC16B/RV08B	7-20,7-23
		(2) XBF-AD04C/DV04C/DC04C	2-2~ 2-8
		(3) XBL-EIMT/EIMF/EIMH/EIPT/CMEA/CSEA/PMEC	2-2~ 2-8
		3. Domain of Homepage Changed	Front/Back Cover
		4. External Memory Module Modified (XBO-M1024B→XBO-M2MB)	6-23~6-30
V1.8	2015.2	1. Data Back-up Time Modified	4-11
		2. Address & phone number Changed	Back Cover
	2015.7	3. Add new module	Ch2.1, Ch2.2
		4. Vibration Specification modified	Ch2.3.3,Ch2.3.4 Ch3.1
V1.9	2016.11	1. Module added (1) XBE-DN32A	Ch7
V 2.0	2020.06	LSIS to change its corporate name to LS ELECTRIC	Entire
V2.1	2022.08	XBC-H Type Renewal content added	Entire
V2.2	2023.06	1. Module added (1)XBE-AC08A	Ch7
		2. Ferrule specification contents added	

About User's Manual

Congratulations on purchasing PLC of LS ELECTRIC Co.,Ltd.

Before use, make sure to carefully read and understand the User's Manual about the functions, performances, installation and programming of the product you purchased in order for correct use and importantly, let the end user and maintenance administrator to be provided with the User's Manual.

The User's Manual describes the product. If necessary, you may refer to the following description and order accordingly. In addition, you may connect our website(<https://www.ls-electric.com/>) and download the information as a PDF file.

Relevant User's Manual

Title	Description	No. of User Manual
XG5000 User's Manual	It describes how to use XG5000 software especially about online functions such as programming, printing, monitoring and debugging by using XGT series products.	10310000512
XGK/XGB Series Instruction & Programming	It describes how to use the instructions for programming using XGK/XGB series.	10310000510
XGB Main unit (XBM-S, XBC-H) User's Manual	It describes how to use the specification of power/input/output/expansion modules, system configuration and built-in High-speed counter for XGB basic unit.	10310000926
XGB Analog User's Manual	It describes how to use the specification of analog input/analog output/temperature input module, system configuration and built-in PID control for XGB basic unit.	10310000920
XGB Cnet I/F User's Manual	It describes how to use built-in communication function for XGB basic unit and external Cnet I/F module.	10310000816
XGB Fast Ethernet I/F User's Manual	It describes how to use XGB FEnet I/F module.	10310000873
CANopen Communication Module	It describes how to use XGB CANopen Communication Module	10310001245
EtherNet/IP Communication Module	It describes how to use XGB EtherNet/IP Communication module	10310001159
XGB Profibus-DP I/F (Master) User's Manual	It describes how to use XGB Profibus-DP I/F (Master) Communication Module	10310001310
XGB Profibus-DP I/F (Slave) User's Manual	It describes how to use XGB Profibus-DP I/F (Slave) Communication Module	10310001410

XGB DeviceNet I/F (Slave) User's Manual	It describes how to use XGB DeviceNet I/F (Slave) Communication Module	10310001414
XGB High speed counter module User's Manual	It describes how to use High speed counter(XBF-HO02A, XBF-HD02A)	10310001240

© Contents ©

Chapter 1 Introduction 1-1~5

1.1 Guide to Use This Manual	1-1
1.2 Features	1-2
1.3 Terminology	1-4

Chapter 2 System Configuration2-1~14

2.1 XGB System Configuration	2-1
2.2 Product List	2-3
2.3 Classification and Type of Product Name	2-5
2.3.1 Classification and type of basic unit	2-5
2.3.2 Classification and type of expansion module	2-6
2.3.3 Classification and type of special module	2-7
2.3.4 Classification and type of communication module	2-8
2.3.5 Classification and type of Option Module.....	2-9
2.4 System Configuration	2-10
2.4.1 Cnet I/F system	2-10
2.4.2 Ethernet system	2-13

Chapter 3 General Specifications3-1~2

3.1 General Specifications.....	3-1
---------------------------------	-----

Chapter 4 CPU Specifications4-1~14

4.1 Performance Specifications	4-1
4.2 Names of Part and Function	4-5
4.3 Power Supply Specifications	4-8
4.4 Calculating Example of Consumption Current/Voltage	4-11
4.5 Battery	4-13
4.5.1 Battery specification.....	4-13
4.5.2 Instruction for Use.....	4-13

4.5.3 Battery life	4-13
4.6 Data Back-up Time	4-14

Chapter 5 Program Configuration and Operation Method	5-1~40
---	---------------

5.1 Program Instruction	5-1
5.1.1 Program execution methods	5-1
5.1.2 Operation processing during momentary power failure	5-2
5.1.3 Scan time	5-3
5.1.4 Scan Watchdog timer	5-4
5.1.5 Timer processing	5-5
5.1.6 Counter processing	5-8
5.2 Program Execution	5-10
5.2.1 Configuration of program	5-10
5.2.2 Program execution methods.....	5-10
5.2.3 Interrupt	5-12
5.3 Operation Mode	5-27
5.3.1 RUN mode	5-27
5.3.2 STOP mode	5-28
5.3.3 DEBUG mode	5-28
5.3.4 Change operation mode	5-32
5.4 Memory	5-33
5.4.1 Data memory	5-33
5.5 Configuration Diagram of Data Memory	5-35
5.5.1 "S" type.....	5-35
5.5.2 "H" type	5-36
5.5.3 Data latch area setting	5-37

Chapter 6 CPU Functions.....	6-1~38
-------------------------------------	---------------

6.1 Type Setting	6-1
6.2 Parameter Setting	6-2
6.2.1 Basic parameter setting	6-2
6.2.2 I/O parameter setting	6-3
6.3 Self-diagnosis Function	6-5
6.3.1 Saving of error log	6-5
6.3.2 Troubleshooting	6-6
6.4 Remote Functions	6-7

6.5 Forced Input/Output On and Off Function.....	6-8
6.5.1 Force I/O setup	6-8
6.5.2 Processing time and method of Forced Input/Output On and Off	6-9
6.6 Direct Input/Output Operation	6-10
6.7 Diagnosis of External Device	6-11
6.8 Allocation of Input/Output Number	6-12
6.9 Online Editing	6-14
6.10 Reading Input/Output Information.....	6-17
6.11 Monitoring	6-19
6.12 RTC function	6-25
6.12.1 How to use	6-25
6.13 External Memory Module	6-27
6.13.1 Memory module specification	6-27
6.13.2 Memory module structure	6-28
6.13.3 How to use memory module	6-28
6.13.4 How to use when password is set	6-32
6.14 Program Upload Prohibit	6-35
6.15 Clear All PLC	6-37
6.16 Password Setting per Program Block	6-38

Chapter 7 Input/Output Specifications	7-1~44
--	---------------

7.1 Introduction	7-1
7.2 Basic Digital Input Unit Specifications	7-8
7.2.1 XBM-DR16S input unit (Source/Sink type).....	7-8
7.2.2 XBM-DN16S input unit (Source/Sink type).....	7-9
7.2.3 XBM-DN32S input unit (Source/Sink type)	7-10
7.2.4 XBC-DR32H / XBC-DN32H input unit (Source/Sink type)	7-11
7.2.5 XBC-DR64H / XBC-DN64H input unit (Source/Sink Type)	7-12
7.3 Basic Digital Output Unit Specifications	7-13
7.3.1 XBM-DR16S relay output unit	7-13
7.3.2 XBM-DN16S transistor output unit (Sink type)	7-14
7.3.3 XBM-DN32S transistor output unit (Sink type)	7-15
7.3.4 XBC-DR32H output unit.....	7-16
7.3.5 XBC-DR64H output unit.....	7-18
7.3.6 XBC-DN32H output unit (Sink type)	7-20
7.3.7 XBC-DN64H output unit (Sink type)	7-22
7.4 Digital Input Module Specifications	7-24

7.4.1 8 point DC24V input module (Source/Sink type)	7-24
7.4.2 16 point DC24V input module (Source/Sink type)	7-25
7.4.3 32 point DC24V input module (Source/Sink type)	7-26
7.4.4 8 point AC110V input module	7-27
7.5 Digital Output Module Specifications	7-28
7.5.1 8 point relay output module	7-28
7.5.2 8 point relay output module	7-29
7.5.3 16 point relay output module	7-30
7.5.4 8 point transistor output module (Sink type)	7-31
7.5.5 16 point transistor output module (Sink type)	7-32
7.5.6 32 point transistor output module (Sink type)	7-33
7.5.7 8 point transistor output module (Source type)	7-34
7.5.8 16 point transistor output module (Source type)	7-35
7.5.9 32 point transistor output module (Source type)	7-36
7.6 Digital I/O Mixed Module Input Specifications	7-37
7.6.1 8 point DC24V input (Source/Sink type)	7-37
7.6.2 16 point DC24V input (Source/Sink type)	7-38
7.7 Digital I/O Mixed Module Output Specifications	7-39
7.7.1 8 point relay output	7-39
7.7.2 16 point transistor output (Sink type)	7-40
7.8 IO Wiring by Using Smart Link Board	7-41
7.8.1 Smart link board	7-41

Chapter 8 Built-in High-speed Counter Function	8-1~54
---	---------------

8.1 High-speed Counter Specifications.....	8-1
8.1.1 Performance specifications	8-1
8.1.2 Designation of parts	8-2
8.1.3 "S" type Functions	8-6
8.1.4 "H" type Functions	8-24
8.2 Installation and Wiring	8-43
8.2.1 Precaution for wiring	8-43
8.2.2 Example of wiring	8-43
8.3 Internal Memory	8-44
8.3.1 Special area for High-speed counter	8-44
8.3.2 Error code	8-52
8.4 Examples: Using High-speed Counter	8-53

Chapter 9 Installation and Wiring9-1~18

9.1 Safety Instruction9-1
 9.1.1 Fail safe circuit..... 9-3
 9.1.2 PLC heat calculation..... 9-6
 9.2 Attachment/Detachment of Modules9-8
 9.2.1 Attachment/Detachment of modules 9-8
 9.2.2 Caution in handling 9-12
 9.3 Wire..... 9-13
 9.3.1 Power wiring 9-14
 9.3.2 I/O Device wiring..... 9-17
 9.3.3 Grounding wiring..... 9-17
 9.3.4 Specifications of wiring cable 9-18

Chapter 10 Maintenance10-1~2

10.1 Maintenance and Inspection 10-1
 10.2 Daily Inspection 10-1
 10.3 Periodic Inspection 10-2

Chapter 11 Troubleshooting 11-1~12

11.1 Basic Procedure of Troubleshooting 11-1
 11.2 Troubleshooting 11-1
 11.2.1 Troubleshooting flowchart used with when the PWR(Power) LED turns Off..... 11-2
 11.2.2 Troubleshooting flowchart used with when the ERR(Error) LED is flickering 11-3
 11.2.3 Troubleshooting flowchart used with when the RUN,STOP LED turns Off. 11-4
 11.2.4 Troubleshooting flowchart used with when the I/O part doesn't operate normally..11-5
 11.3 Troubleshooting Questionnaire 11-7
 11.4 Troubleshooting Examples 11-8
 11.4.1 Input circuit troubles and corrective actions 11-8
 11.4.2 Output circuit and corrective actions..... 11-9
 11.5 Error Code List 11-11

Appendix 1 Flag ListApp. 1-1~10

Appendix 1.1 Special Relay (F) List..... App. 1-1

Appendix 1.2 Communication Relay (L) List..... App. 1-6
 Appendix 1.3 Network Register (N) List App. 1-10

Appendix 2 DimensionApp.2-1~6

Appendix 3 Compatibility with MASTER-K.....App.3-1~6

Appendix 4 Instruction List.....App.4-1~40

Appendix 4.1 Classification of Instructions App.4-1
 Appendix 4.2 Basic Instructions App.4-2
 Appendix 4.3 Application Instruction App.4-5
 Appendix 4.4 Special/Communication Instruction..... App.4-37

Chapter 1 Introduction

1.1 Guide to Use This Manual

This manual includes specifications, functions and handling instructions for the XGB series PLC. This manual is divided up into chapters as follows.

No.	Title	Contents
Chapter 1	Introduction	Describes configuration of this manual, unit's features and terminology.
Chapter 2	System Configurations	Describes available units and system configuration in the XGB series.
Chapter 3	General Specifications	Describes general specifications of units used in the XGB series.
Chapter 4	CPU Specifications	Describes performances, specifications and operations.
Chapter 5	Program Configuration and Operation Method	
Chapter 6	CPU Module Functions	
Chapter 7	Input/Output Specifications	Describes operation of basic and input/output.
Chapter 8	Built-in High-speed Counter Function	Describes built-in high-speed counter functions.
Chapter 9	Installation and Wiring	Describes installation, wiring and handling instructions for reliability of the PLC system.
Chapter 10	Maintenance	Describes the check items and method for long-term normal operation of the PLC system.
Chapter 11	Troubleshooting	Describes various operation errors and corrective actions.
Appendix 1	Flag List	Describes the types and contents of various flags.
Appendix 2	Dimension	Shows dimensions of the main units and expansion modules.
Appendix 3	Compatibility with MASTER-K	Describes the compatibility with MASTER-K.
Appendix 4	Instruction List	Describes the special relay and instruction list.

1.2 Features

The features of XGB system are as follows.

(1) The system secures the following high performances.

- (a) High Processing Speed
- (b) Max. 384 I/O control supporting small & mid-sized system implementation

Item	Type			Reference
	XBM-DxxxS	XBC-DxxxH (O/S Ver: Less than V5.00)	XBC-DxxxH (O/S Ver: V5.00 or later)	
Operation processing speed	160ns / Step	83ns / Step	60ns / Step	-
Max IO contact point	256 points	384 points	384 points	
Program capacity	10Kstep	15Kstep	15Kstep	-
Max. no. of expanded base	7	10	10	-

- (c) Enough program capacity
 - (d) Expanded applications with the support of floating point.
 - (e) XBM-DxxxS is expressed “S” type and XBC-DxxxH is expressed “H” type.
- (2) Compact : the smallest size comparing to the same class model of competitors.
- (a) Compact panel realized through the smallest size.

Item	Type	Size (W * H * D)	Reference
Basic unit	XBC-Dx32H	114 * 90 * 64	“H” type
	XBC-Dx64H	180 * 90 * 64	
	XBM-DxxxS	30 * 90 * 64	“S” type
Extension module	XBE-,XBF-,XBL-	20 * 90 * 60	Basis of minimum size

(3) Easy attachable/extensible system for improved user convenience.

- (a) Easy attachable to European terminal board and convenient-to-use MIL connector method improving convenient wiring. (“S” type basic unit and expanded module)
- (b) By adopting a removable terminal block connector (M3 X 6 screw), convenience of wiring may be increased.
- (c) By adopting connector coupling method, modules may be easily connected and separated.

(4) Improved maintenance ability with kinds of register, built-in RTC (“H” type), comment backup and etc

- (a) Convenient programming environment by providing analogue register and index register.
- (b) Improved maintenance ability by operating plural programs and task program through module program.
- (c) Built-in Flash ROM enabling permanent backup of program without any separate battery.
- (d) Improved maintenance ability by types of comment backup.
- (e) Built-in RTC function enabling convenient history and schedule management

- (5) Optimized communication environment.
 - (a) With max. 2 channels of built-in COM (excl. loader), up to 2 channel communication is available without any expanded of module.
 - (b) Supporting various protocols to improve the convenience (dedicated, Modbus, user-defined communication)
 - (c) Communication module may be additionally increased by adding modules (up to 2 stages such as Cnet, Enet and etc).
 - (d) Convenient network-diagnostic function through network & communication frame monitoring.
 - (e) Convenient networking to upper systems through Enet or Cnet.
 - (f) High speed program upload and download by USB Port

- (6) Applications expanded with a variety of I/O modules.
 - (a) 8, 16, 32 points modules provided (if relay output, 8/16 points module).
 - (b) Single input, single output and combined I/O modules supported.

- (7) Applications expanded through analog-dedicated register design and full attachable mechanism.
 - (a) All analogue modules can be attachable on extension base. (H type: up to 10 stages available)
 - (b) With analog dedicated register(U) and monitoring dedicated function, convenient use for I/O is maximized (can designate operations using easy programming of U area and monitoring function)

- (8) Through XG5000, it provides an integrated programming environment such as enhanced program convenience and various monitoring, diagnosis, and editing functions.

- (9) Built-in high speed counter function
 - (a) Providing High-speed counter 1phase, 2phase and more additional functions.
 - (b) Providing parameter setting, diverse monitoring and diagnosis function using XG5000.
 - (c) Monitoring function in XG5000 can inspect without program, inspecting external wiring, data setting and others.

- (10) Built-in position control function
 - (a) Supporting max 100Kpps 2 axes.
 - (b) Providing parameter setting, operation data collection, diverse monitoring and diagnosis by using XG5000.
 - (c) Commissioning by monitoring of XG5000, without program, inspecting external wiring and operation data setting.

(11) Built-in PID

- (a) Supporting max. 16 loops.
- (b) Setting parameters by using XG5000 and supporting loop status monitoring conveniently with trend monitor.
- (c) Control constant setting through the improved Auto-tuning function.
- (d) With many other additional functions including PWM output, ΔMV , ΔPV and SV Ramp, improving the control preciseness.
- (e) Supporting types of control modes such as forward/backward mixed operation, 2-stage SV PID control, cascade control and etc.
- (f) A variety of warning functions such as PV MAX and PV variation warning securing the safety.

1.3 Terminology

The following table gives definition of terms used in this manual.

Terms	Definition	Remark
Module	A standard element that has a specified function which configures the system. Devices such as I/O board, which inserted onto the mother board.	Example) Expansion module, Special module, Communication module
Unit	A single module or group of modules that perform an independent operation as a part of PLC systems.	Example) Main unit, Expansion unit
PLC System	A system which consists of the PLC and peripheral devices. A user program can control the system.	-
XG5000	A program and debugging tool for the MASTER-K series. It executes program creation, edit, compile and debugging. (PADT: Programming Added Debugging Tool)	-
I/O image area	Internal memory area of the CPU module which used to hold I/O status.	
Cnet	Computer Network	-
FEnet	Fast Ethernet Network	-
RAPInet	RAPInet Network	-
CANopen	Controller Area Network	-
Pnet	Profibus-DP Network	
Dnet	DeviceNet Network	
RTC	Abbreviation of 'Real Time Clock'. It is used to call general IC that contains clock function.	-
Watchdog Timer	Supervisors the pre-set execution times of programs and warns if a program is not completed within the pre-set time.	-

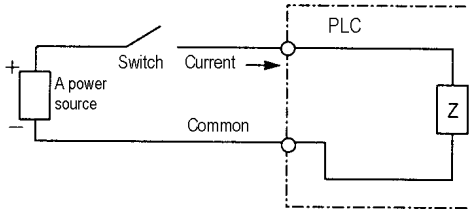
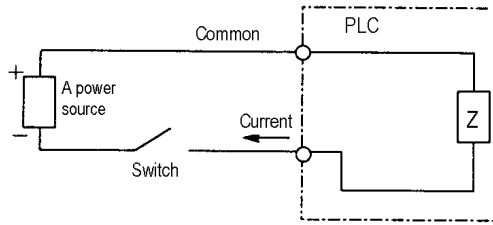
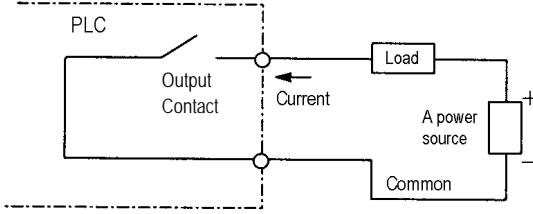
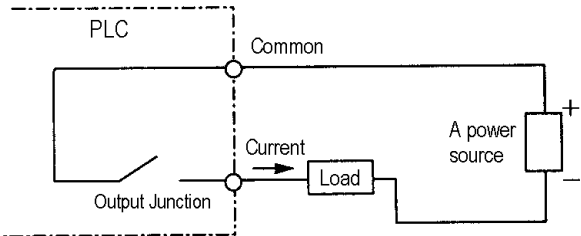
Terms	Definition	Remark
Sink Input	<p>Current flows from the switch to the PLC input terminal if a input signal turns on.</p> 	Z: Input impedance
Source Input	<p>Current flows from the PLC input terminal to the switch after a input signal turns on.</p> 	-
Sink Output	<p>Current flows from the load to the output terminal and the PLC output turn on.</p> 	-
Source Output	<p>Current flows from the output terminal to the load and the PLC output turn on.</p> 	-

Chapter 2 System Configuration

The XGB series has suitable to configuration of the basic, computer link and network systems.

This chapter describes the configuration and features of each system.

2.1. XGB System Configuration

XGB series System Configuration is as follows. Expanded I/O module and special module are available to connect maximum 7 stages for "S" type and 10 stages for "H" type. Expanded communication module is available to connect maximum 2 stages.

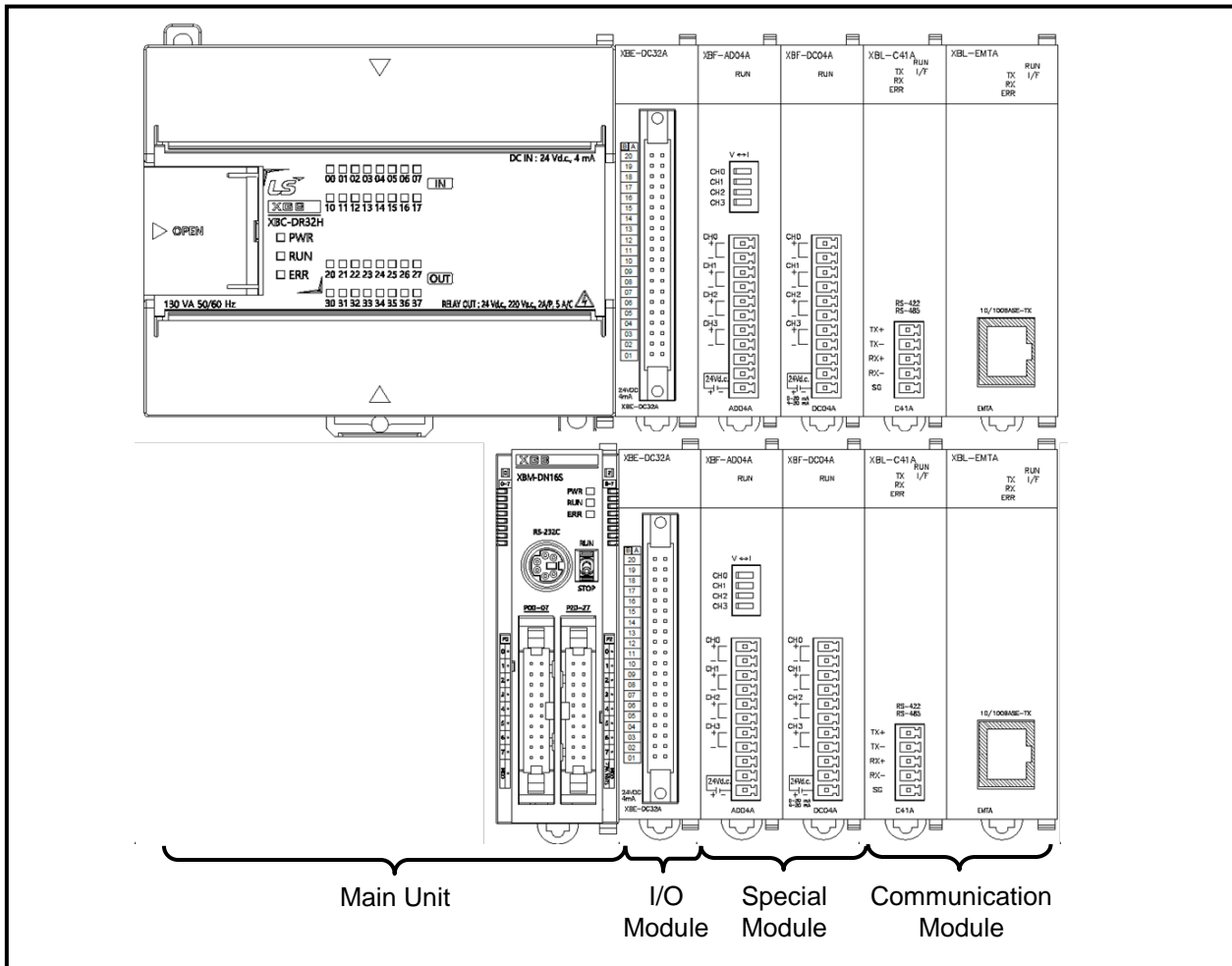

Item		Description	
Total I/O points		• XBC-DxxxH (“H” type): 32~384 points	
		• XBM-DxxxS (“S” type): 16~256 points	
Maximum number of expansion modules	Digital I/O module	• “S” type: Max. 7 / “H” type: Max. 10	
	Special module	• “S” type: Max. 7 / “H” type: Max. 10	
	Communication I/F module	• Maximum 2	
Items	Main unit	“H” type	• refer to 2.2 Product List
		“S” type	
	Expansion module	Digital I/O module	
		A/D·D/A module	
		Communication I/F module	

2.2. Product List

XGB series' product list is as follows.

Types	Model	Description	Remark	
Main Unit	XBC-DR32H	AC100-240V power supply, DC24V input 16 point, Relay output 16 point	"H" type	
	XBC-DN32H	AC100-240V power supply, DC24V input 16 point, Transistor output 16 point		
	XBC-DR64H	AC100-240V power supply, DC24V input 32 point, Relay output 32 point		
	XBC-DN64H	AC100-240V power supply, DC24V input 32 point, Transistor output 32 point		
	XBC-DR32HL	AC100-240V power supply, DC24V input 16 point, relay output 16 point		
	XBC-DR32H/DC	DC 24V power supply, DC24V input 16 point, relay output 16 point		
	XBC-DN32H/DC	DC 24V power supply, DC24V input 16 point, TR output 16 point		
	XBC-DR64H/DC	DC 24V power supply, DC24V input 32 point, relay output 32 point		
	XBC-DN64H/DC	DC 24V power supply, DC24V input 32 point, TR output 32 point		
	XBM-DN16S	DC24V Power supply, DC24V Input 8 point, Transistor output 8 point	"S" type	
	XBM-DN32S	DC24V Power supply, DC24V Input 16 point, Transistor output 16 point		
	XBM-DR16S	DC24V Power supply, DC24V Input 8 point, Relay output 8 point		
Expansion Unit	XBE-DC08A	DC24V Input 8 point	Input	
	XBE-DC16A/B	DC24V Input 16 point		
	XBE-DC32A	DC24V Input 32 point		
	XBE-AC08A	AC110V Input 8 point	Output	
	XBE-RY08A	Relay output 8 point		
	XBE-RY08B	Relay output 8 point(isolated ouput)		
	XBE-RY16A	Relay output 16 point		
	XBE-TN08A	Transistor output 8 point (sink type)		
	XBE-TN16A	Transistor output 16 point (sink type)		
	XBE-TN32A	Transistor output 32 point (sink type)		
	XBE-TP08A	Transistor output 8 point (source type)		
	XBE-TP16A	Transistor output 16 point (source type)		
	XBE-TP32A	Transistor output 32 point (source type)		
	XBE-DR16A	DC24V Input 8 point, Relay output 8 point		In/Output
	XBE-DN32A	DC24V Input 16 point, Transistor output 16 point (sink type)		
Special Module	XBF-AD04A	Current/Voltage input 4 channel	Analog In/Out	
	XBF-AD04C	Current/Voltage input 4 channel, High resolution		
	XBF-AD08A	Current/Voltage input 8 channel		
	XBF-DC04A	Current output 4 channel		
	XBF-DC04C	Current output 4 channel, High resolution		
	XBF-DV04A	Voltage output 4 channel		
	XBF-DV04C	Voltage output 4 channel, High resolution		
	XBF-AH04A	Current/Voltage input 2 channel, Current/Voltage output 2 channel,		

Types	Model	Description	Remark
Special Module	XBF-RD04A	RTD (Resistance Temperature Detector) input 4 channel	Temperature
	XBF-RD01A	RTD (Resistance Temperature Detector) input 1 channel	
	XBF-TC04S	TC (Thermocouple) input 4 channel	
	XBF-PD02A	Position 2Axis, Line Drive type	Position
	XBF-HD02A	High Speed Counter 2 channel, Line Drive Type	Counter
	XBF-HO02A	High Speed Counter 2 channel, Open Collector Type	
	XBF-TC04RT	Temperature controller module (RTD input, 4 roof)	Temperature
	XBF-TC04TT	Temperature controller module (TC input, 4 roof)	
	XBF-LD02S	Isolated-type Loadcell Input 2 channels	
Communication Module	XBL-C21A	Cnet (RS-232C/Modem) I/F	-
	XBL-C41A	Cnet (RS-422/485) I/F	-
	XBL-EMTA	Enet I/F	-
	XBL-EIMT	RAPIenet I/F 2 UTP cable	-
	XBL-EIPT	EtherNet I/P Module	-
	XBL-CMEA	CANopen Master I/F	-
	XBL-CSEA	CANopen Slave I/F	-
	XBL-PMEC	Pnet I/F	-
	XBL-RMEA	Rnet Master	
Option module	XBO-M1024A	Memory module	-
Down load cable	PMC-310S	Connection cable (PC to PLC), 9pin(PC)-6pin(PLC)	-
	USB-301A	Connection cable (PC to PLC), USB	--

Note

Download Cable (PMC-310S) Diagram

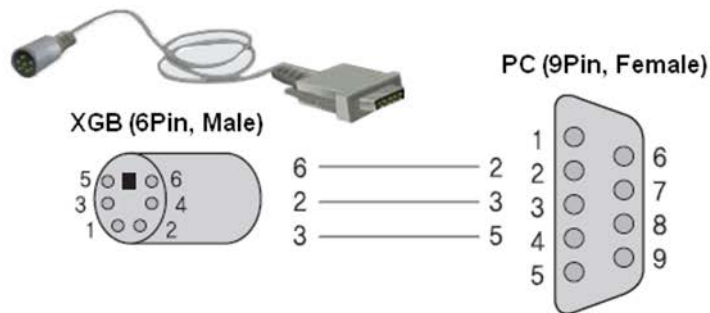

2.3. Classification and Type of Product Name

2.3.1 Classification and type of basic unit

Name of basic unit is classified as follows.

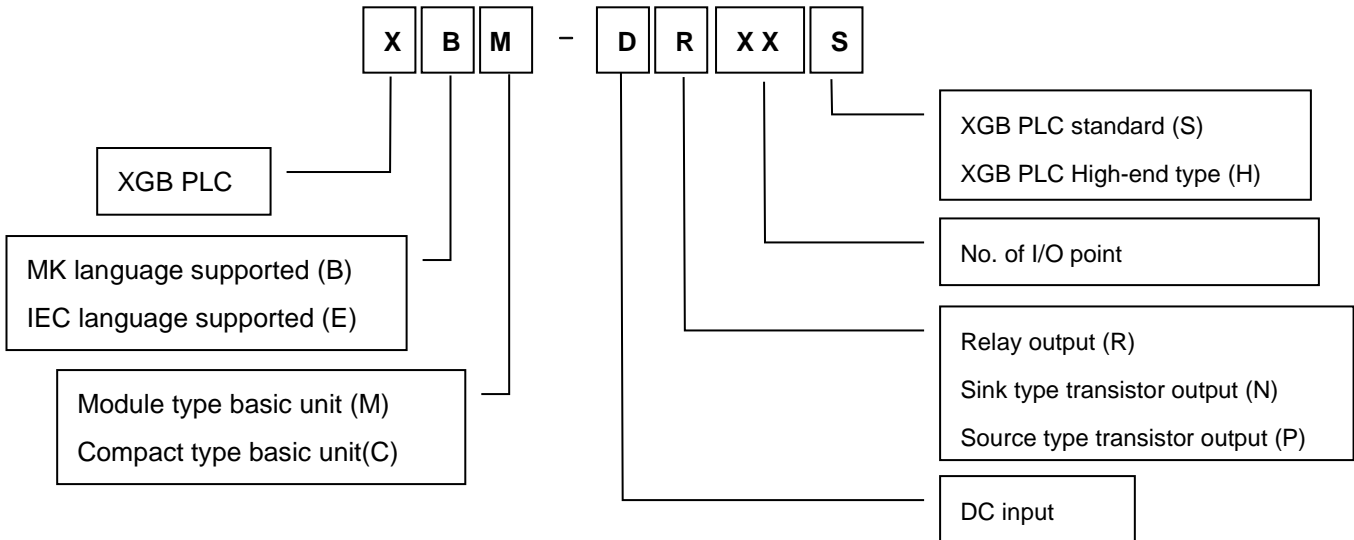

Classification	Name	DC input	Relay output	Transistor output	Power
Module type basic unit	XBM-DR16S	8 point	8 point	None	DC24V
	XBM-DN16S	8 point	None	8 point	
	XBM-DN32S	16 point	None	16 point	
Compact type basic unit	XBC-DR32H	16 point	16 point	None	AC110V-220V
	XBC-DN32H	16 point	None	16 point	
	XBC-DR64H	32 point	32 point	None	
	XBC-DN64H	32 point	None	32 point	
	XBC-DR32HL	16 point	16 point	None	DC24V
	XBC-DR32H/DC	16 point	16 point	None	
	XBC-DN32H/DC	16 point	None	16 point	
	XBC-DR64H/DC	32 point	32 point	None	
XBC-DN64H/DC	32 point	None	32 point		

2.3.2 Classification and type of expansion module

Name of expansion module is classified as follows.

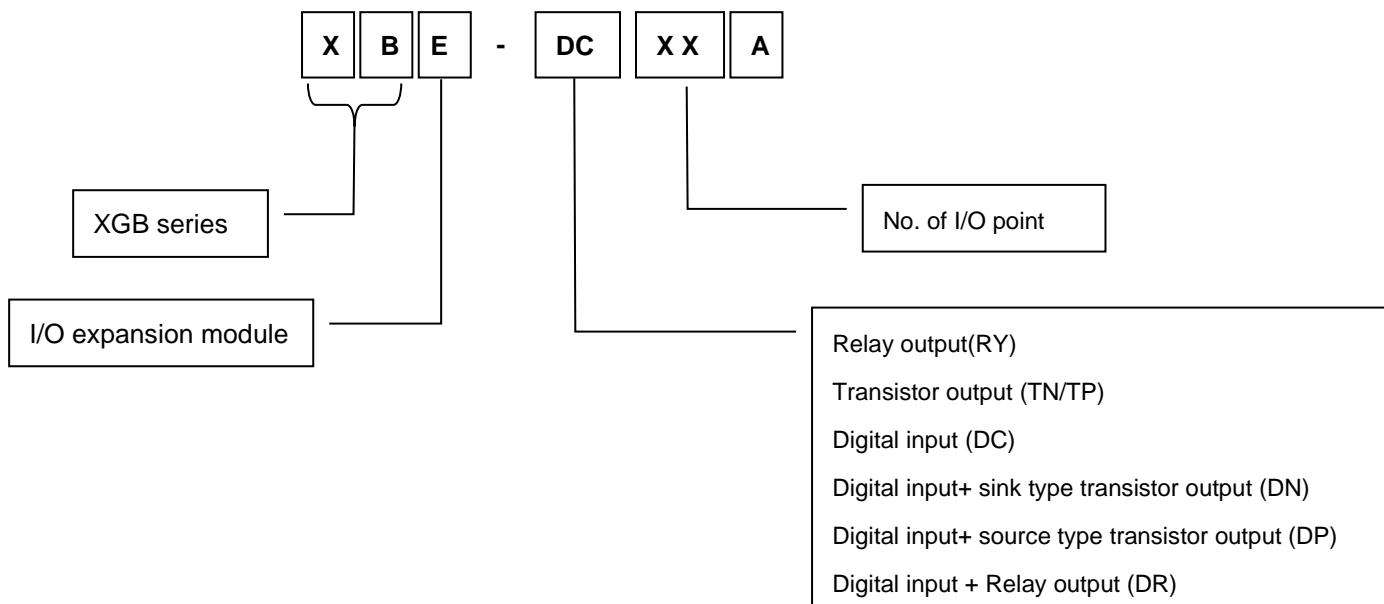

Name	DC input	Relay output	Transistor output	Reference
XBE-DC08A	8 point	None	None	Input
XBE-DC16A/B	16 point	None	None	
XBE-DC32A	32 point	None	None	
XBE-AC08A	8 point (AC)	None	None	
XBE-RY08A/B	None	8 point	None	Relay Output
XBE-RY16A	None	16 point	None	
XBE-TN08A	None	None	8 point (sink type)	Sink type Output
XBE-TN16A	None	None	16 point (sink type)	
XBE-TN32A	None	None	32 point (sink type)	
XBE-TP08A	None	None	8 point (source type)	Source type Output
XBE-TP16A	None	None	16 point (source type)	
XBE-TP32A	None	None	32 point (source type)	
XBE-DR16A	8 point	8 point	None	In/Output
XBE-DN32A	16 point	None	16 point (sink type)	

2.3.3 Classification and type of special module

Special module is classified as follows.

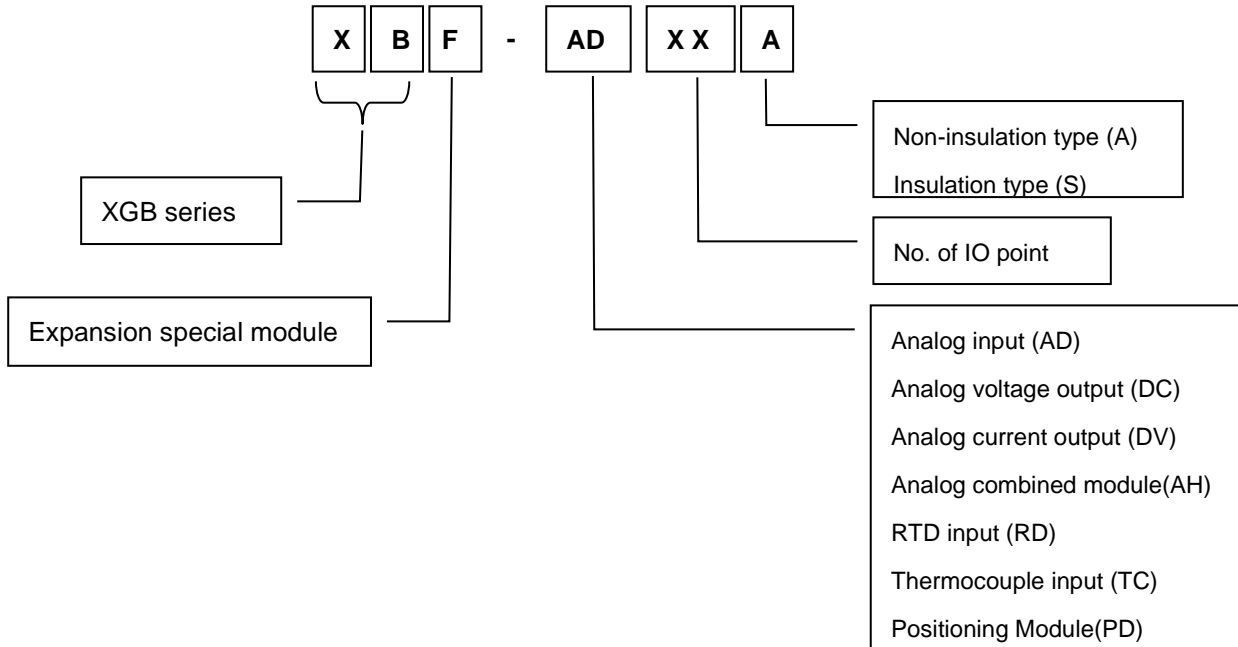

Classification	Name	No. of input ch.	Input type	No. of output ch.	Output type
Analog input	XBF-AD04A/C	4	Voltage/Current	None	-
	XBF-AD08A	8	Voltage/Current	None	-
Analog output	XBF-DC04A/C	None	-	4	Current
	XBF-DV04A/C	None	-	4	Voltage
	XBF-DV04A	None	-	4	Voltage
	XBF-AH04A	2	Voltage/Current	2	Voltage/Current
RTD input	XBF-RD04A	4	PT100/JPT100	None	-
	XBF-RD01A	1	PT100/JPT100	None	-
TC input	XBF-TC04S	4	K, J, T, R	None	-
	XBF-TC04RT	4	PT100/JPT100	4	Transister
	XBF-TC04TT	4	K, J, T, R	4	Transister
Positioning	XBF-PD02A	-	Line Driver	2	Voltage
High Speed Counter	XBF-HD02A	2	Line Driver	-	-
	XBF-HO02A	2	Open Collector	-	-
Loadcell	XBF-LD02A	2	Volatage	-	-

2.3.4 Classification and type of communication module

Name of communication module is classified as follows.

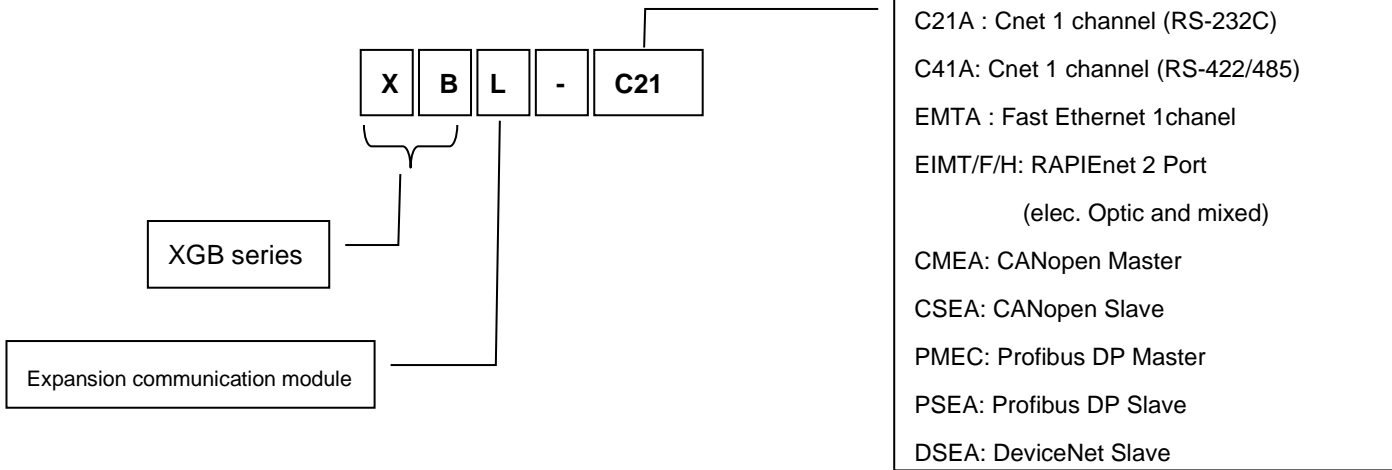

Classification	Name	Type
Cnet Comm. Module	XBL-C21A	RS-232C, 1 channel
	XBL-C41A	RS-422/485, 1 channel
FEnet Comm. Module	XBL-EMTA	Electricity, open type Ethernet
RAPIEnet Comm. Module	XBL-EIMT/EIMF/EIMH	Comm. Module between PLCs, electric media, 100 Mbps industrial Ethernet supported
EtherNet Comm. Module	XBL-EIPT	Open EtherNet I/P
CANopen Comm. Module	XBL-CMEA	CANopen Master
	XBL-CSEA	CANopen Slave
Pnet Comm. Module	XBL-PMEC	Profibus-DP Master
	XBL-PSEA	Profibus-DP Slave
DeviceNet Comm. Module	XBL-DSEA	DeviceNet Slave
Rnet Comm. Module	XBL-RMEA	RemoteNet Master

2.3.5 Classification and Type of Option Module

Name of option module is classified as follows.

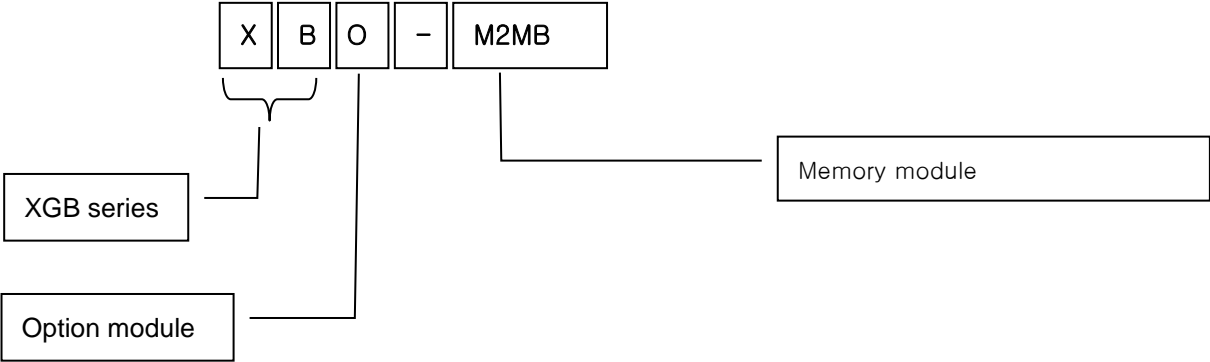

Classification	Name	Type
Memory module	XBO-M1024A	Memory module

2.4. System Configuration

2.4.1 Cnet I/F system

Cnet I/F System is used for communication between the main unit and external devices using RS-232C/RS-422 (485) Interface. The XGB series has a built-in RS-232C port, RS-485 port and has also XBL-C21A for RS-232C, XBL-C41A for RS-422/485. It is possible to construct communication systems on demand.

1) 1:1 communication system

- (1) 1:1 communication of an external device (computer) with main unit using a built-in port (RS-232C/RS-485)

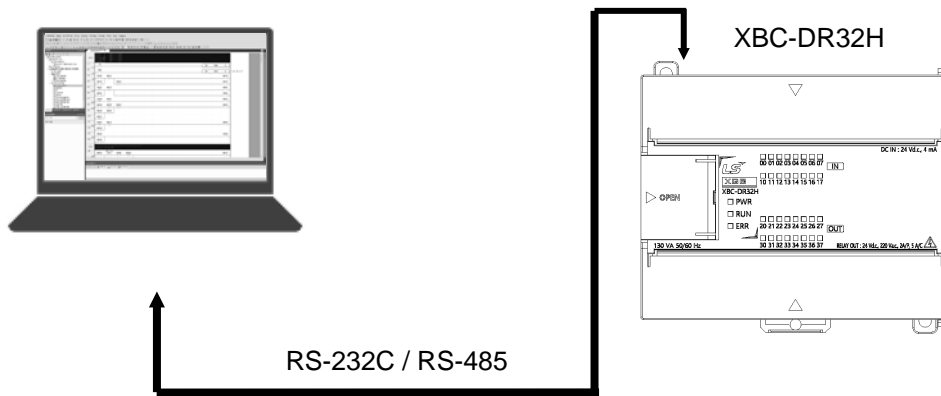

- (2) 1:1 communication with main unit using a built-in RS-485 port (In case of built-in RS-232C, it is for connecting to HMI device.)

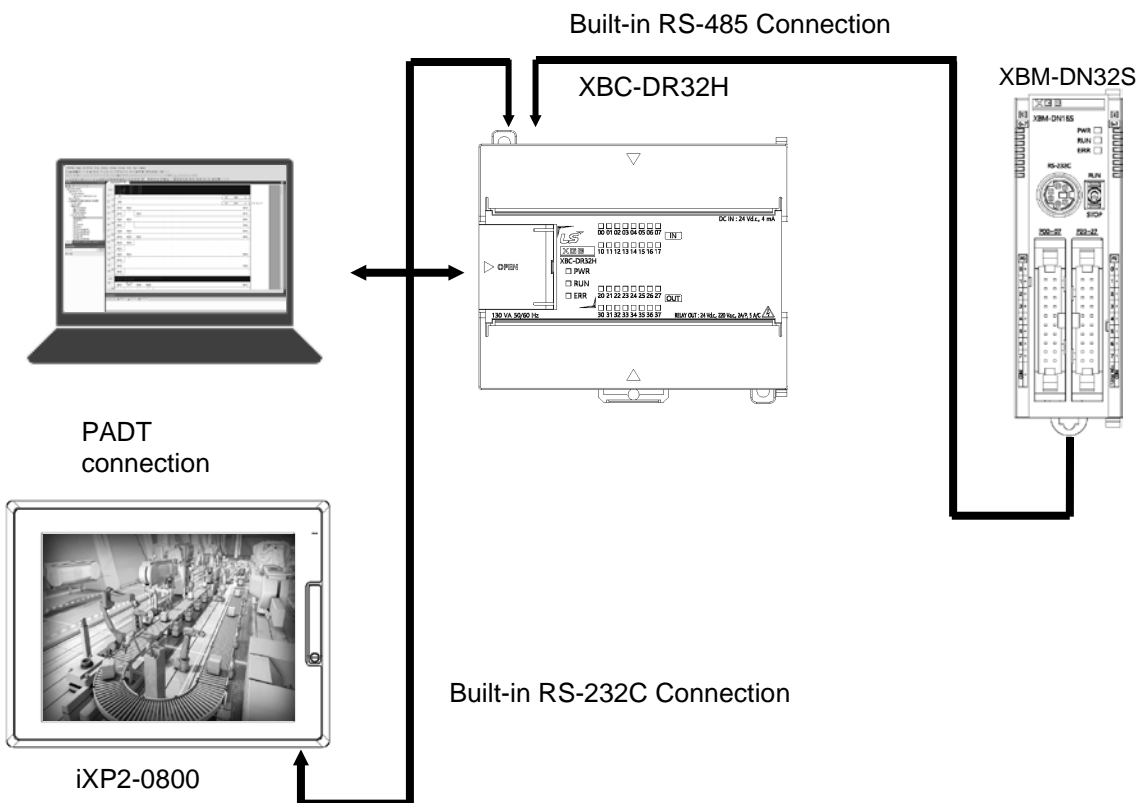

(3) 1:1 RS-232C Communication with remote device via modem by Cnet I/F modules

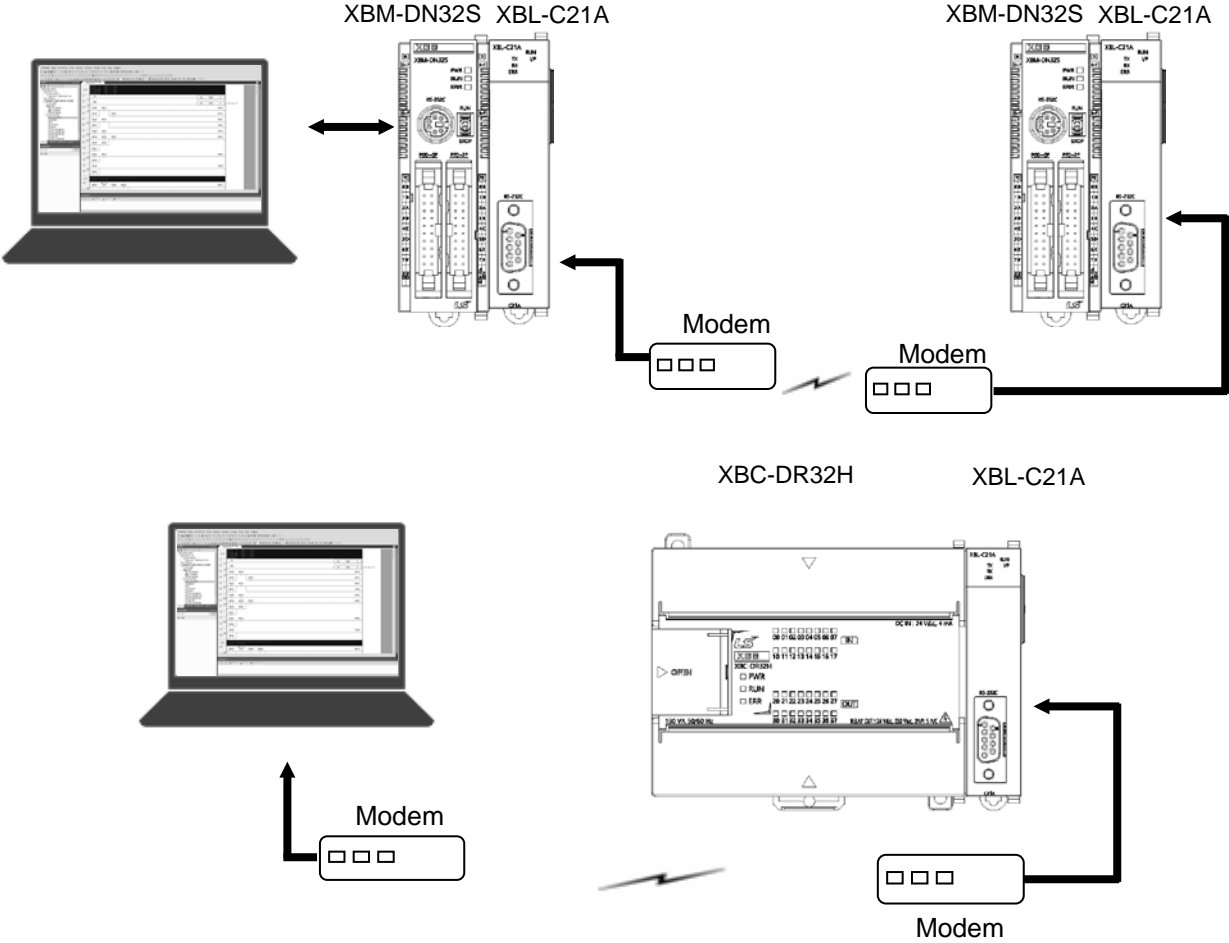

(4) 1:1 communication of an external device (monitoring unit) with main unit using a built-in RS-232C/485 port.

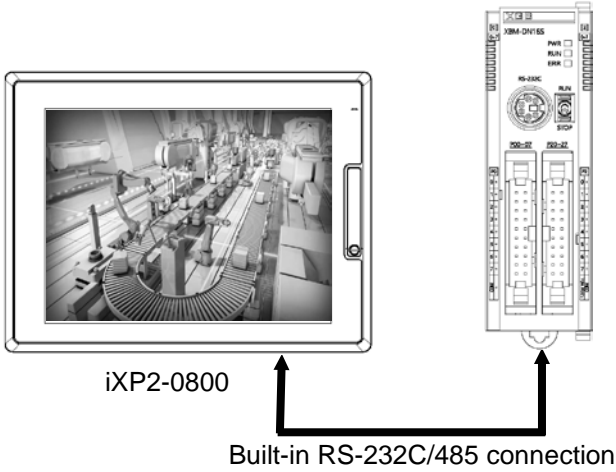

Chapter 2. System Configuration

2) 1:n Communication system

- (1) Using RS-485 built-in function can connect between one computer and multiple main units for up to 32 stations.

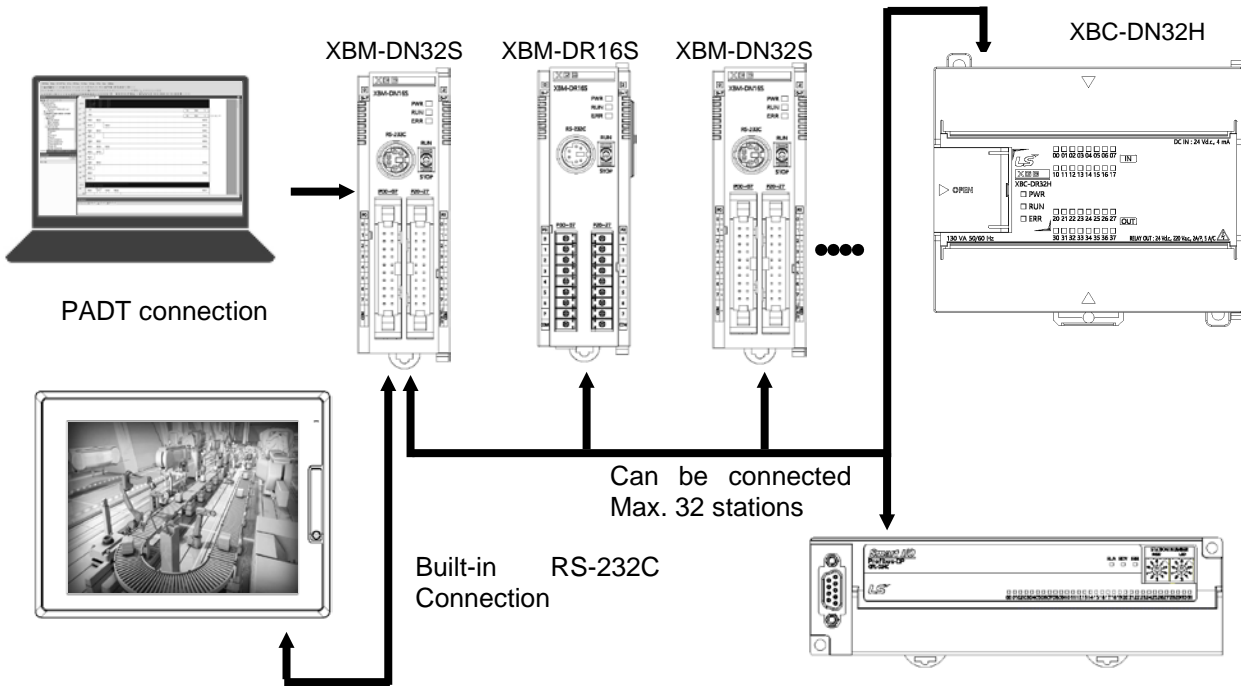

- (2) Using RS-485 built-in function/expansion Cnet I/F module can be connect for up to 32 stations.

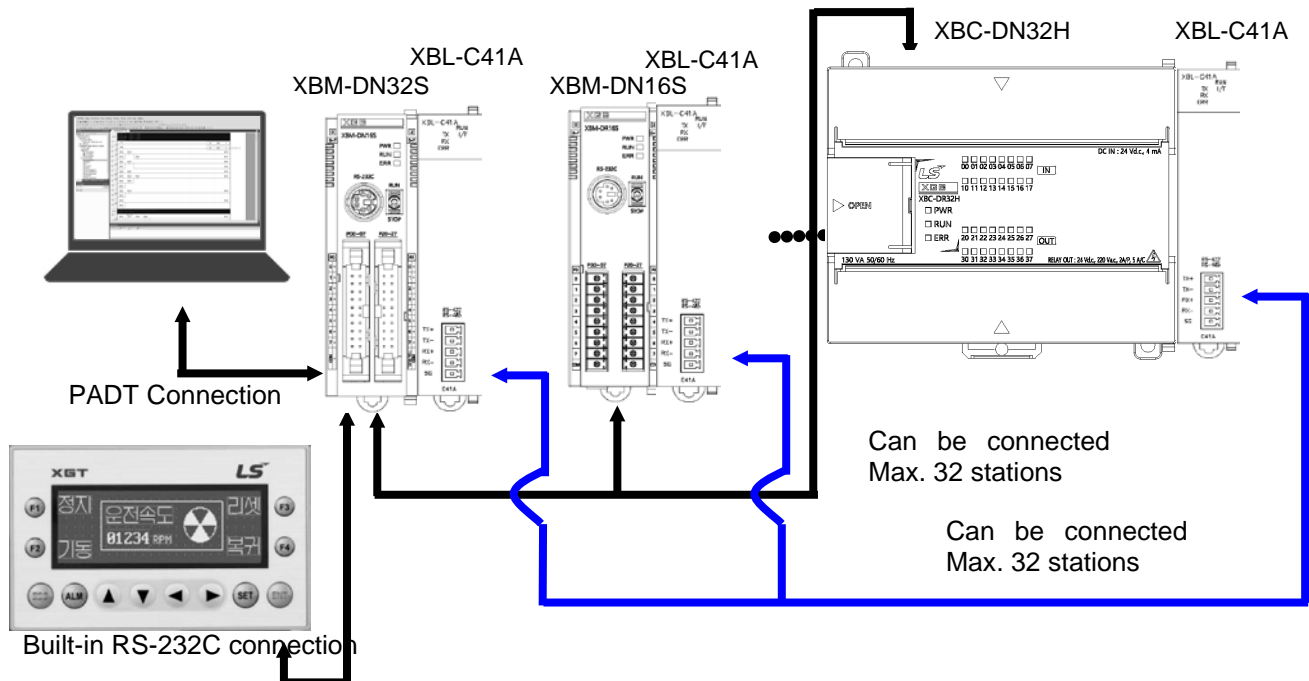

Note

- 1) Refer to 'XGB Cnet I/F user manual' for details

2.4.2 Ethernet system

Ethernet made by cooperation of Xerox, Intel, DEC is standard LAN connection method (IEEE802.3), which is network connection system using 1.5KB packet with 100Mbps transmission ability. Since Ethernet can combine a variety of computer by network, it is called as standard specification of LAN and diverse products. By adopting CSMA/CD method, it is easy to configure the network and collect large capacity data.

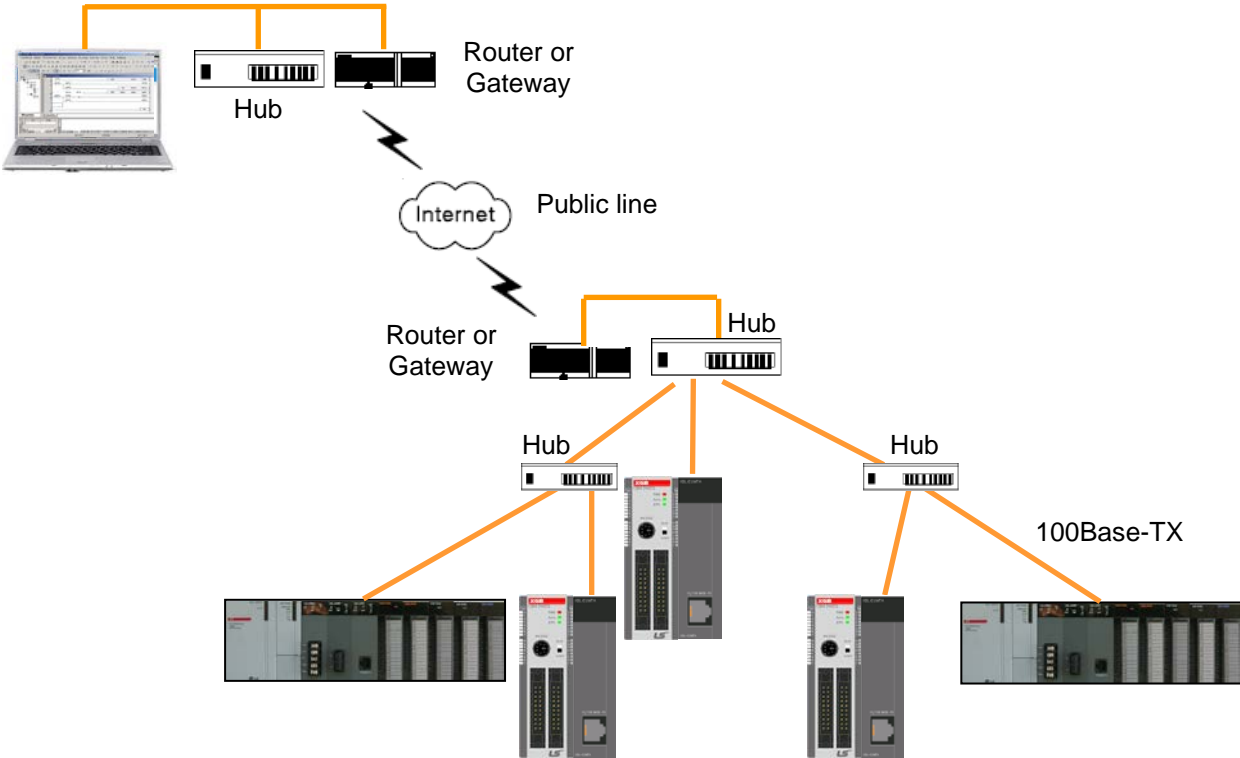

Note

1) Refer to 'XGB FEnet I/F user manual' for details

Chapter 3 General Specifications

3.1 General Specifications

The General specification of XGB series is as below.

No.	Items	Specification	Reference		
1	Ambient Temp.	0 ~ 55 °C	-		
2	Storage Temp.	-25 ~ +70 °C			
3	Ambient humidity	5 ~ 95%RH (Non-condensing)			
4	Storage humidity	5 ~ 95%RH (Non-condensing)			
5	Vibration	Occasional vibration		-	
		Frequency	Acceleration	Pulse width	10 times each direction (X,Y and Z)
		5 ≤ f < 8.4Hz	-	3.5mm	
		8.4 ≤ f ≤ 150Hz	9.8m/s ² (1G)	-	
		Continuous vibration			
		Frequency	Acceleration	Pulse width	
		5 ≤ f < 8.4Hz	-	1.75mm	
8.4 ≤ f ≤ 150Hz	4.9m/s ² (0.5G)	-			
6	Shocks	<ul style="list-style-type: none"> • Peak acceleration : 147 m/s²(15G) • Duration : 11ms • Pulse wave type : Half-sine (3 times each direction per each axis) 			
7	Impulse noise	Square wave impulse noise	AC: ±1,500 V DC: ±900 V	LS ELECTRIC standard	
		Electrostatic discharge	Voltage: 4kV (Contact discharge)		IEC61131-2 IEC61000-4-2
		Radiated electromagnetic field noise	80 ~ 1,000 MHz, 10V/m		IEC61131-2, IEC61000-4-3
		Fast transient /Burst noise	Classifi- cation Voltage	Power supply 2kV	Digital/Analog Input/Output, Communication Interface 1kV
8	Operation ambience	Free from corrosive gases and excessive dust		-	
9	Altitude	Less than 2,000m			
10	Pollution degree	Less than 2			
11	Cooling method	Air-cooling			

Notes

1) IEC (International Electrotechnical Commission)

: An international civil community that promotes international cooperation for standardization of electric/electro technology, publishes international standard and operates suitability assessment system related to the above.

2) Pollution Degree

: An index to indicate the pollution degree of used environment that determines the insulation performance of the device. For example, pollution degree 2 means the state to occur the pollution of non-electric conductivity generally, but the state to occur temporary electric conduction according to the formation of dew.

Chapter 4 CPU Specifications

4.1 Performance Specifications

The following table shows the general specifications of the XGB module type CPU.

Items		Specifications ("S" type)			Remark
		XBM-DR16S	XBM-DN16S	XBM-DN32S	
Program control method		Cyclic execution of stored program, Time-driven interrupt, Process-driven interrupt			-
I/O control method		Batch processing by simultaneous scan (Refresh method), Directed by program instruction			
Program language		Ladder Diagram, Instruction List			
Number of instructions	Basic	About 30			
	Application	About 540			
Processing speed (Basic instruction)		0.16 μ S/Step			
Program capacity		10 ksteps			
Max. I/O points		240 point (Main + Expansion 7 stages)		256 point	
Data area	P	P0000 ~ P127F (2,048 point)			
	M	M0000 ~ M255F (4,096 point)			
	K	K00000 ~ K2559F (Special area: K2600~2559F) (40,960 point)			
	L	L00000 ~ L1279F (20,480 point)			
	F	F000 ~ F255F (4,096 point)			
	T	100ms, 10ms, 1ms : T000 ~ T255 (Adjustable by parameter setting)			
	C	C000 ~ C255			
	S	S00.00 ~ S127.99			
	D	D0000 ~ D5119 (5120 word)			
	U	U00.00 ~ U07.31 (Analog data refresh area: 256 word)			
Z	Z000~Z127 (128 Word)			Word	
N	N0000~N3935 (3936 Word)				
Total program		128			-
Initial task		1 (_INT)			
Cyclic task		Max. 8			
I/O task		Max. 8			
Internal device task		Max. 8			
Operation mode		RUN, STOP, DEBUG			
Self-diagnosis function		Detects errors of scan time, memory, I/O and power supply			
Program port		RS-232C (Loader)			
Back-up method		Latch area setting in basic parameter			
Internal consumption current		400 mA	250 mA	280 mA	
Weight		140 g	100 g	110 g	

The following table shows the general specifications of the XGB compact type CPU (XBC-DR32/64H, XBC-DN32/DN64).

Items		Specifications ("H" type)				Remark
		XBC-DN32H (/DC)	XBC-DR32H (/DC)	XBC-DN64H (/DC)	XBC-DR64H (/DC)	
Program control method		Cyclic execution of stored program, Time-driven interrupt, Process-driven interrupt				
I/O control method		Batch processing by simultaneous scan (Refresh method), Directed by program instruction				
Program language		Ladder Diagram, Instruction List				
Number of instructions	Basic	About 30				
	Application	About 540				
Processing speed (Basic instruction)		O/S Version V5.00 or later: 60ns/Step O/S Version Less than V5.00: 83ns/Step				
Program capacity		15 Kstep				
Max. I/O points		352 point (Main + Expansion 10 stages)		384 point (Main + Expansion 10 stages)		
Data area	P	P0000 ~ P1023F (16,384 point)				
	M	M0000 ~ M1023F (16,384 point)				
	K	K0000 ~ K4095F (65,536 point)				
	L	L0000 ~ L2047F (32,768 point)				
	F	F0000 ~ F1023F (16,384 point)				
	T	100ms, 10ms, 1ms : T0000 ~ T1023 (1,024 point) (Adjustable by parameter setting)				
	C	C0000 ~ C1023 (1,024)				
	S	S00.00 ~ S127.99				
	D	D0000 ~ D10239 (10,240 word)				
	U	U00.00 ~ U0A.31 (Analog data refresh area: 352 word)				
Z	Z000~Z127 (128 Word)				Word	
N	N0000~N5119 (5,120 Word)					
R	R0000~R10239 (10,240 Word)					
Total program		128				
Initial task		1 (_INT)				
Cyclic task		Max. 8				
I/O task		Max. 8				
Internal device task		Max. 8				

Chapter 4. CPU Specifications

Operation mode	RUN, STOP, DEBUG				
Self-diagnosis function	Detects errors of scan time, memory, I/O and power supply				
Program port	RS-232C 1 channel, USB 1 channel (USB 1.1 supported)				
Back-up method	Latch area setting in basic parameter				
Internal consumption current	260 mA	660 mA	330 mA	1,040 mA	
Weight	500 g	600 g	800 g	900 g	

Items		Specifications		Remark			
		"S" type	"H" type				
Built-in function	PID control function		Controlled by instructions, Auto-tuning, PWM output, Manual output, Adjustable operation scan time, Anti Windup, Delta MV function, SV-Ramp function		-		
	Cnet I/F function		Dedicated protocol support MODBUS protocol support User defined protocol support } RS-232C 1 port RS-485 1 port				
	High-speed counter	Capacity	1 phase: 20 kHz 4 channel 2 phase: 10 kHz 2 channel	1 phase: 100 kHz 4 channel, 20kHz 4 channel 2 phase: 50 kHz 2 channel, 10kHz 2 channel			
		Counter mode	4 different counter modes according to input pulse and addition/subtraction method <ul style="list-style-type: none"> • 1 phase pulse input: addition/subtraction counter • 1 phase pulse input: addition/subtraction counter by B phase • 2 phase pulse input: addition/subtraction counter • 2 phase pulse input: addition/subtraction by phase differences 				
		Additional function	<ul style="list-style-type: none"> • Internal/External preset function • Latch counter function • Comparison output function • Revolution number per unit time function 				
	Positioning function	Basic function		No. of control axis: 2 axes Control method: position/speed control Control unit: pulse Positioning data: 30 data/axis (operation step No. 1~30) Operation mode: End/Keep/Continuous Operation method: Single, Repeated operation		No. of control axis: 2 axes Control method: position/speed control Control unit: pulse Positioning data: 80 data/axis (operation step No. 1~80) Operation mode: End/Keep/Continuous Operation method: Single, Repeated operation	
		Positioning function		Positioning method: Absolute / Incremental Address range: -2,147,483,648 ~ 2,147,483,647 Speed: Max. 100Kpps(setting range 1 ~ 100,000pps) Acceleration / Deceleration method : trapezoidal method		TR output type support	
		Return to Origin		Origin detection when approximate origin turns off Origin detection when approximate origin turns on Origin detection by approximate origin.			
		JOG operation		Setting range: 1~100,000 (High / Low speed)			
		Additional function		Inching operation, Speed synchronizing operation, Position synchronizing operation, linear interpolation operation etc.			
Pulse catch		50 μ S 8 point (P0000 ~ P0007)	10 μ S 4 point (P0000 ~ P0003) 50 μ S 4 point (P0004 ~ P0007)	-			
External interrupt		8 point: 50 μ S (P0000 ~ P0007)	10 μ S 4 point (P0000 ~ P0003) 50 μ S 4 point (P0004 ~ P0007)				
Input filter		Select among 1,3,5,10,20,70,100 ms (Adjustable)					

4.2 Names of Part and Function

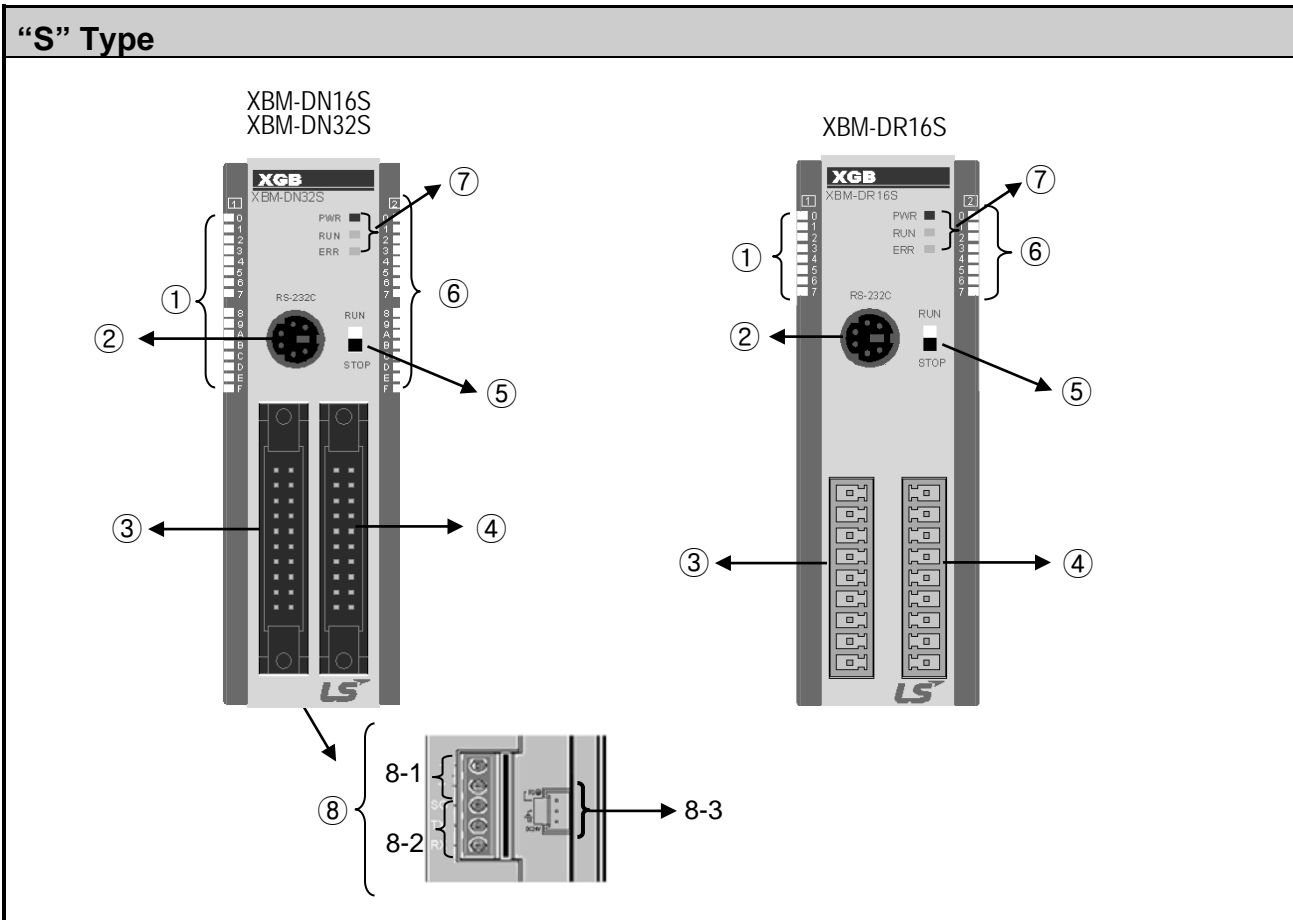

No.	Name	Description
①	Input indicator LED	▪ Input indicator LED
②	PADT connecting connector	▪ PADT connecting connector
③	Input connector and terminal block	▪ Input connector and terminal block
④	Output connector and terminal block	▪ Output connector and terminal block
⑤	Key switch	▪ RUN / STOP Key switch In case of STOP mode, Remote mode changeable.
⑥	Output indicator LED	▪ Output indicator LED
⑦	Status indicator LED	It indicates CPU module's status. ▪ PWR(Red): Power status ▪ RUN(Green): RUN status STOP mode: Off/ RUN mode : On ▪ Error(Red): In case of error, it is flickering.

No.	Name	Description
⑧	8-1	Built-in RS-485 connecting connector <ul style="list-style-type: none">• Built-in RS-485 connecting connector - “+”, “-” terminal connecting connector in RS-485 communication
	8-2	Built-in RS-232C connecting connector <ul style="list-style-type: none">• Built-in RS-232C connecting connector - “TxD”, “RxD”, “GND” terminal connecting connector in RS-232C communication
	8-3	Power supply connector <ul style="list-style-type: none">• Power supply connector (24V)

“H” Type			
No.	Name	Description	
①	Input indicator LED	▪ Input indicator LED	
②	PADT connecting connector	▪ PADT connecting USB (USB 1.1 supported) 1 channel, RS-232C 1 channel connector	
③	Input connector and terminal block	▪ Input connector and terminal block	
④	Output connector and terminal block	▪ Output connector and terminal block	
⑤	Key switch	▪ RUN / STOP Key switch In case of STOP mode, Remote mode changeable.	
⑥	Output indicator LED	▪ Output indicator LED	
⑦	Status indicator LED	It indicates CPU module's status. ▪ PWR(Red): Power status ▪ RUN(Green): RUN status STOP mode: Off/ RUN mode : On ▪ Error(Red): In case of error, it is flickering.	
⑧	8-1	Built-in RS-232C / RS-485 Connecting connector	<ul style="list-style-type: none"> ▪ Built-in RS-485 connecting connector “+”, “-” terminal connecting connector in RS-485 communication ▪ Built-in RS-232C connecting connector “TxD”, “RxD”, “GND” connecting connector in RS-232C
	8-2	Power supply connector	▪ AC100~240V power supply connector

4.3 Power Supply Specifications

It describes the power supply specification of main unit.

Items		Specification ("S" type)
Input	Rated voltage	DC24V
	Input voltage range	DC20.4~28.8V (-15%, +20%)
	Inrush current	70A _{Peak} or less
	Input current	1A (Typ.550 mA)
	Efficiency	60% or more
	Permitted momentary power failure	Less than 10 ms
Output	Output voltage	DC5V (±2%)
	Output current	1.5 A
Power supply status indication		LED On when power supply is normal
Cable specification		0.75 ~ 2 mm ²

Items		Specification ("H" type)				
		XBC-DR32H, XBC-DN32H	XBC-DR64H, XBC-DN64H	XBC-DR32H/DC, XBC-DN32H/DC	XBC-DR64H/DC, XBC-DN64H/DC	
Input	Rated voltage (UL warranty voltage)	AC 100 ~ 240 V		DC 24V		
	Input voltage range	AC85~264V(-15%, +10%)		DC19.2~28.8V(-20%, +20%)		
	Inrush current	50A _{Peak} or less				
	Input current	AC 220V : 0.5A or less, AC 110V : 1A or less		0.7A or less	1A or less	
	Efficiency	65% or more				
	Permitted momentary power failure	Less than 10 ms				
Output	Rated output	DC5V	2A	3A	2A	3A
		DC24V	0.4A	0.6A	-	-
	Output voltage ripple	DC5V (±2%)				
Power supply status indication		LED On when power supply is normal				
Cable specification		0.75 ~ 2 mm ²				

* Use the power supply which has 4 A or more fuse for protecting power supply.

1) Consumption current (DC 5V)

Item	Model	Current consumption
Main unit	XBM-DR16S	400
	XBM-DN16S	250
	XBM-DN32S	280
	XBC-DR32H	510
	XBC-DR64H	970
	XBC-DN32H	180
	XBC-DN64H	240
	XBC-DR32H/DC	510
	XBC-DR64H/DC	970
	XBC-DN32H/DC	180
	XBC-DN64H/DC	240
	Expansion I/O module	XBE-DC32A
XBE-DC16A		40
XBE-DC08A		30
XBE-AC08A		30
XBE-RY16A		420
XBE-RY08A		230
XBE-TN32A		120
XBE-TN16A		60
XBE-TN08A		40
XBE-TP32A		120
XBE-TP16A		60
XBE-TP08A		40
XBE-DR16A		280
XBE-DN32A		60
Expansion special module		XBF-AD04A
	XBF-DV04A	110
	XBF-DC04A	110
	XBF-RD04A	100
	XBF-RD01A	100
	XBF-TC04S	100
	XBF-PD02A	500
	XBF-HO02A	270
	XBF-HD02A	330
	XBF-AD04C	105

	XBF-DC04C	70
	XBF-DV04C	70
	XBF-TC04RT	120
	XBF-TC04TT	120
	XBF-LD02S	110
Expansion communication module	XBL-C21A	110
	XBL-C41A	110
	XBL-EMTA	190
	XBL-EIMT/F/H	280/670/480
	XBL-EIPT	400
	XBL-CMEA	150
	XBL-CSEA	150
	XBL-PMEC	300
	XBL-PSEA	230
	XBL-DSEA	100
	XBL-RMEA	250

4.4 Calculation Example of Consumption Current/Voltage

Calculate the consumption current and configure the system not to exceed the output current capacity of basic unit.

(1) XGB PLC configuration example 1

Consumption of current/voltage is calculated as follows.

Type	Model	Unit No.	Internal 5V consumption current (Unit : mA)	Remark
Main unit	XBM-DN16S	1	250	In case contact points are On. (Maximum consumption current)
Expansion module	XBE-DC32A	2	50	
	XBE-TN32A	2	120	All channel is used. (Maximum consumption current)
	XBF-AD04A	1	120	
	XBF-DC04A	1	110	
	XBL-C21A	1	110	
Consumption current	930 mA			-
Consumption voltage	4.65 W			$0.93 * 5V = 4.65W$

In case system is configured as above, since 5V consumption current is total 930mA and 5V output of XGB standard type main unit is maximum 1.5A, normal system configuration is available.

(2) XGB PLC configuration example 2

Type	Model	Unit No.	Internal 5V consumption current (Unit : mA)	Remark
Main unit	XBM-DR16S	1	400	In case all contact points are On. (Maximum consumption current)
Expansion module	XBE-DR16A	3	280	
	XBE-TN32A	2	120	All channel is used. (Maximum consumption current)
	XBF-AD04A	1	120	
	XBL-C21A	1	110	
Consumption current	1,710 mA			-
Consumption voltage	8.55W			$1.710 * 5V = 8.55W$

If system is configured as above, total 5V current consumption is exceeded 1,710 mA and it exceeds the 5V output of XGB standard type main unit. Normal system configuration is not available. Although we assume the above example that all contact points are on, please use high-end type main unit which 5V output capacity is higher than standard type main unit.

(3) XGB PLC configuration example 3

Type	Model	Unit No.	Internal 5V consumption current (Unit : mA)	Remark
Main unit	XBC-DR32H	1	510	In case of all contact points are On. (Maximum consumption current)
Expansion module	XBE-DR16A	3	280	
	XBE-TN32A	2	80	All channel is used. (Maximum consumption current)
	XBF-AD04A	1	120	
	XBL-C21A	1	110	
Consumption current	1,740 mA			-
Consumption voltage	8.7W			$1.74 * 5V = 8.7W$

The above system is an example using XBC-DR32H about system example (2). Unlike (2) example, 5V output capacity of XBC-DR32H is maximum 2A, normal configuration is available.

Remark

Calculating of consumption current is based on maximum consumption current. In application system, the consumption current is consumed less than above calculation.

4.5 Battery

This contents is only applied to “H” type.

4.5.1 Battery specification

Items	Specifications																				
Nominal voltage / current	DC 3.0V / 6.5 mAh																				
Warranty term	3 years(at room temperature)																				
Purpose	RTC operation during the blackout																				
Charging time	<table border="1"> <caption>Charging Time Data</caption> <thead> <tr> <th>Charging Time (h)</th> <th>Charging Percentage (%)</th> </tr> </thead> <tbody> <tr><td>0</td><td>0</td></tr> <tr><td>4</td><td>25</td></tr> <tr><td>8</td><td>35</td></tr> <tr><td>12</td><td>45</td></tr> <tr><td>24</td><td>65</td></tr> <tr><td>36</td><td>80</td></tr> <tr><td>48</td><td>90</td></tr> <tr><td>60</td><td>95</td></tr> <tr><td>72</td><td>100</td></tr> </tbody> </table>	Charging Time (h)	Charging Percentage (%)	0	0	4	25	8	35	12	45	24	65	36	80	48	90	60	95	72	100
Charging Time (h)	Charging Percentage (%)																				
0	0																				
4	25																				
8	35																				
12	45																				
24	65																				
36	80																				
48	90																				
60	95																				
72	100																				
Backup time	About 6 months(25°C) <table border="1"> <thead> <tr> <th>surroundin g temperature</th> <th>Back-up time</th> </tr> </thead> <tbody> <tr> <td>70°C</td> <td>about 195 days</td> </tr> <tr> <td>25°C</td> <td>about 183 days</td> </tr> <tr> <td>-25°C</td> <td>about 133 days</td> </tr> </tbody> </table>	surroundin g temperature	Back-up time	70°C	about 195 days	25°C	about 183 days	-25°C	about 133 days												
surroundin g temperature	Back-up time																				
70°C	about 195 days																				
25°C	about 183 days																				
-25°C	about 133 days																				

4.5.2 Instruction for Use

The built-in battery of the XBC high-end type can be replaced through a service center.

4.5.3 Battery Life

Battery’s life may be different depending on the conditions of blackout time, service temperature, etc. Battery can be charged when power is on, and be used for RTC function. If the battery voltage is discharged below 2V due to not using the PLC for a long time, the battery may not be charged. Recharge within 6 months (when stored at 25°C) after fully charged. If the battery is not charged, replace the battery through a service center. In this case, the PLC clock must be set again, but the program and backed up data are maintained and preserved regardless of whether the battery is discharged or not.

4.6 Data Back-up Time

Super capacitor-based data backup is applied to XBM series.

Model	Backup time	Note
XBM-DR16S XBM-DN16S XBM-DN32S	10 days	Standard ambient temperature (25°C)

Remark

- (1) It takes about 30minutes to charge XBM super capacitor
- (2) In case of data backup failure within backup time, please contact LS ELECTRIC distributors.
- (3) The backup time depends on the ambient temperature. The higher the temperature is, the shorter the backup time will be.

Chapter 5 Program Configuration and Operation Method

5.1 Program Instruction

5.1.1 Program execution methods

1) Cyclic operation method (Scan)

This is a basic program proceeding method of PLC that performs the operation repeatedly for the prepared program from the beginning to the last step, which is called 'program scan'. The series of processing like this is called 'cyclic operation method'. The processing is divided per stage as below.

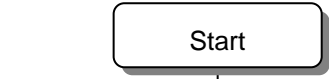
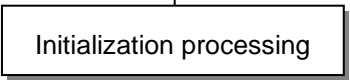
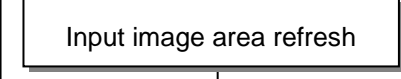
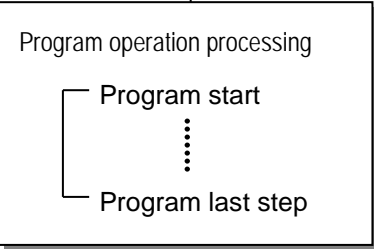
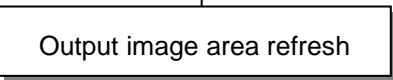
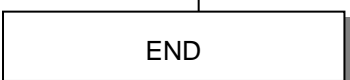
Stage	Processing description
 <p>Start</p>	-
 <p>Initialization processing</p>	<ul style="list-style-type: none"> • A stage to start the scan processing which is executed once when power is applied or Reset is executed, as below. <ul style="list-style-type: none"> ▶ Self-diagnosis execution ▶ Data clear ▶ Address allocation of I/O module and type register • If initializing task is designated, Initializing program is executed.
 <p>Input image area refresh</p>	<ul style="list-style-type: none"> • Reads the state of input module and saves it in input image area before starting the operation of program.
 <p>Program operation processing</p> <p>Program start ⋮ Program last step</p>	<ul style="list-style-type: none"> • Performs the operation in order from the program start to last step.
 <p>Output image area refresh</p>	<ul style="list-style-type: none"> • Performs the operation in order from the program start to last step.
 <p>END</p>	<ul style="list-style-type: none"> • A processing stage to return to the first step after CPU module completes 1 scan processing and the processing performed is as below. <ul style="list-style-type: none"> ▶ Update the current value of timer and counter etc. ▶ User event, data trace service ▶ Self-diagnosis ▶ High speed link, P2P e-Service ▶ Check the state of key switch for mode setting

2) Interrupt operation (Cycle time, Internal device)

This is the method that stops the program operation in proceeding temporarily and carries out the operation processing which corresponds to interrupt program immediately in case that there occurs the status to process emergently during PLC program execution.

The signal to inform this kind of urgent status to CPU module is called 'interrupt signal'. There is a Cycle time signal that operates program every appointed time and external interrupt signal that operates program by external contact (I/O; P000~P007). Besides, there is an internal device start program that starts according to the state change of device assigned inside.

3) Constant Scan (Fixed Period)

This is the operation method that performs the scan program every appointed time. This stands by for a while after performing all the scan program, and starts again the program scan when it reaches to the appointed time. The difference from constant program is the update of input/output and the thing to perform with synchronization.

At constant operation, the scan time indicates the net program processing time where the standby time is deducted. In case that scan time is bigger than 'constant', [F0005C] '_CONSTANT_ER' flag shall be 'ON'.

5.1.2 Operation processing during momentary power failure

CPU module detects the momentary power failure when input power voltage supplied to power module is lower than the standard. If CPU module detects the momentary power failure, it carries out the operation processing as follows.

If momentary power failure within 10 ms is occurred, main unit (CPU) keeps the operation. But, if momentary power failure above 10 ms, the operation is stop and the output is Off. Restart processing like at power input shall be performed.

1) Momentary power failure within 10 ms

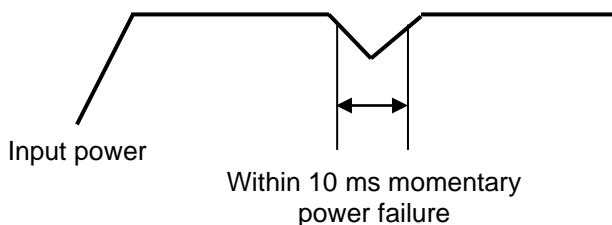

- CPU keeps the operation.

2) Momentary power failure exceeding 10 ms

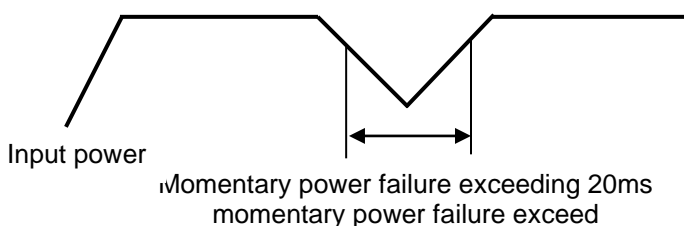

- Restart processing like at power input shall be performed.

Remark

1) Momentary power failure?

This means the state that the voltage of supply power at power condition designated by PLC is lowered as it exceeds the allowable variable range and the short time (some ms ~ some dozens ms) interruption is called 'momentary power failure').

5.1.3 Scan time

The processing time from program step 0 to the next step 0 is called 'Scan Time'.

1) Scan time calculation expression

Scan time is the sum of the processing time of scan program and interrupt program prepared by the user and PLC internal time, and is distinguished by the following formula.

(1) Scan time = Scan program processing time + Interrupt program processing time + PLC internal processing time

- Scan program processing time = processing time of user program not saved as interrupt program
- Interrupt program processing time = Sum of interrupt program proceeding time processed during 1 scan
- PLC internal processing time = Self-diagnosis time + I/O refresh time + Internal data processing time + Communication service processing time

(2) Scan time depends on whether to execute interrupt program and communication processing.

2) Scan time monitor

(1) Scan time can be monitored 『Online』 - 『PLC Information』 - 『Performance』 .

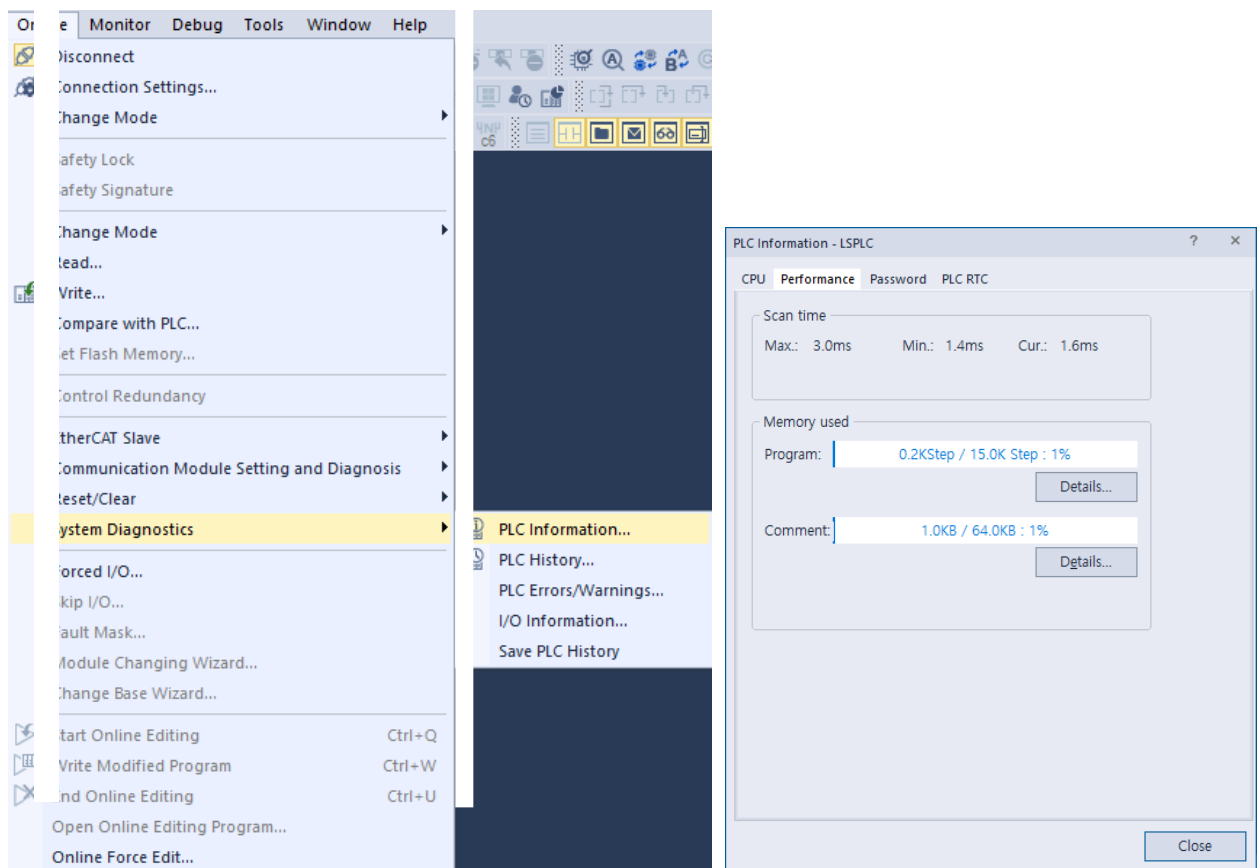

(2) Scan time is save in special relay (F) area as follows.

- F0050: max. value of scan time (unit: 0.1 ms)
- F0051: min. value of scan time (unit: 0.1 ms)
- F0052: current value of scan time (unit: 0.1 ms)

5.1.4 Scan Watchdog timer

WDT (Watchdog Timer) is the function to detect the program congestion by the error of hardware and software of PLC CPU module.

1) WDT is the timer used to detect the operation delay by user program error. The detection time of WDT is set in Basic parameter of XG5000.

2) If WDT detects the excess of detection setting time while watching the elapsed time of scan during operation, it stops the operation of PLC immediately and keeps or clears the output according to parameter setting

3) If the excess of Scan Watchdog Time is expected in the program processing of specific part while performing the user program (FOR ~ NEXT instruction, CALL instruction), clear the timer by using 'WDT' instruction.

'WDT' instruction initializes the elapsed time of Scan Watchdog Timer and starts the time measurement from 0 again.

(For further information of WDT instruction, please refer to Instruction.)

4) To clear the error state of watchdog, we can use the following method : power re-supply, manipulation of manual reset switch, mode conversion to STOP mode.

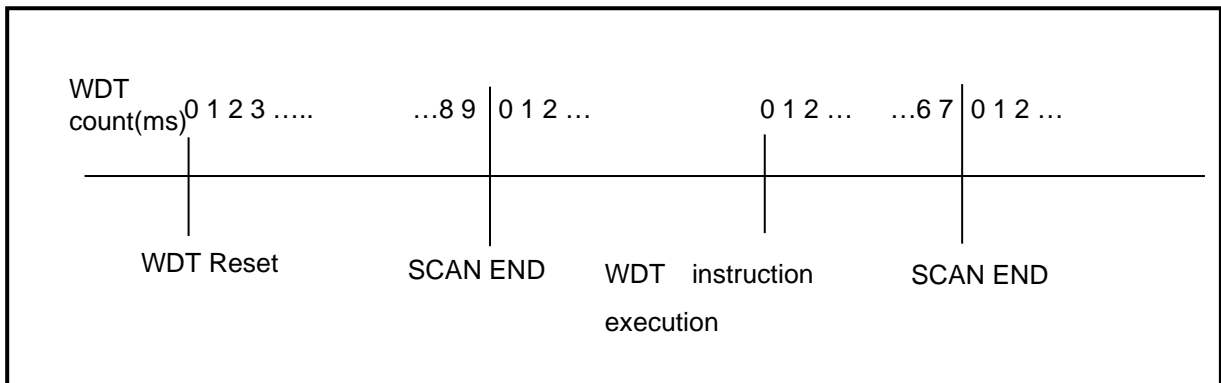

Remark

1) The setting range of Watchdog Timer is 10 ~ 1000ms (Unit: 1ms).

5.1.5 Timer processing

The XGB series use up count timer. There are 5 timer instructions such as on-delay (TON), off-delay (TOFF), integral (TMR), monostable (TMON), and re-triggerable (TRTG) timer.

The measuring range of 100msec timer is 0.1 ~ 6553.5 seconds, 10msec timer is 0.01 ~ 655.35 seconds, and that of 1msec timer is 0.001 ~ 65.53 seconds. Please refer to the 'XG5000 User manual' for details.

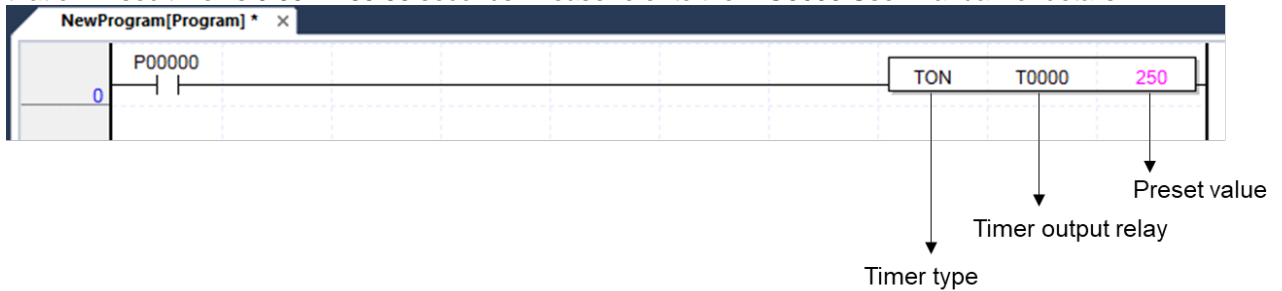

1) On delay timer

The current value of timer starts to increase from 0 when the input condition of TON instruction turns on. When the current value reaches the preset value (Current value=Preset value), the timer output relay (Txxxx) turns on. When the timer input condition is turned off, the current value becomes 0 and the timer output relay is turned off.

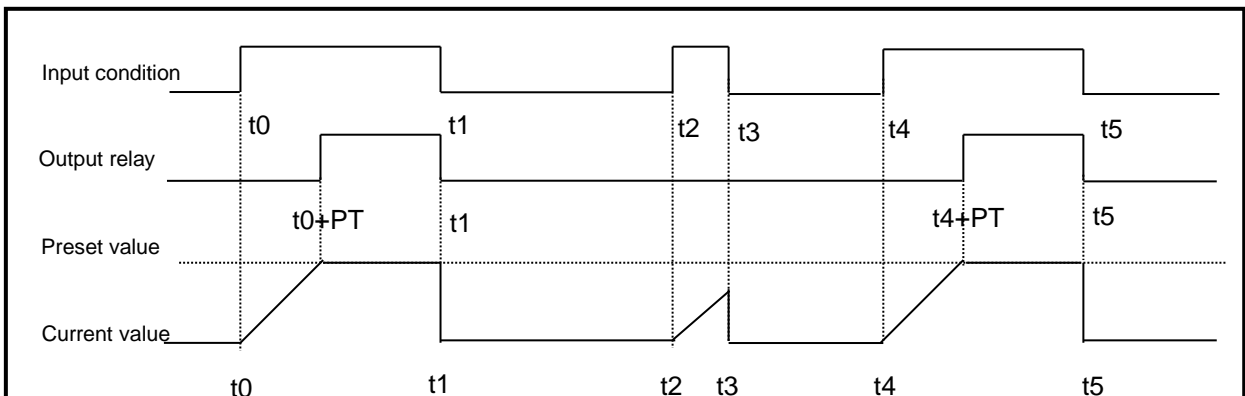

2) Off delay timer

The current value of timer set as preset value and the timer output relay is turned on when the input condition of TOFF instruction turns on. When the input condition is turned off, the current value starts to decrease. The timer output relay is turned off when the current value reaches 0.

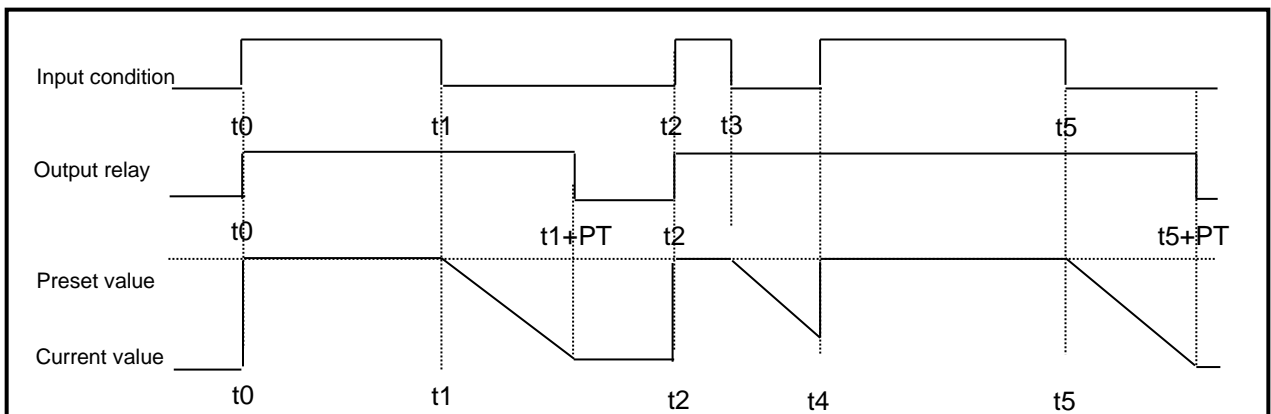

3) Integral timer

In general, its operation is same as on-delay timer. Only the difference is the current value will not be clear when the input condition of TMR instruction is turned off. It keeps the elapsed value and restart to increase when the input condition is turned on again. When the current value reaches preset value, the timer output relay is turned on.

The current value can be cleared by the RST instruction only.

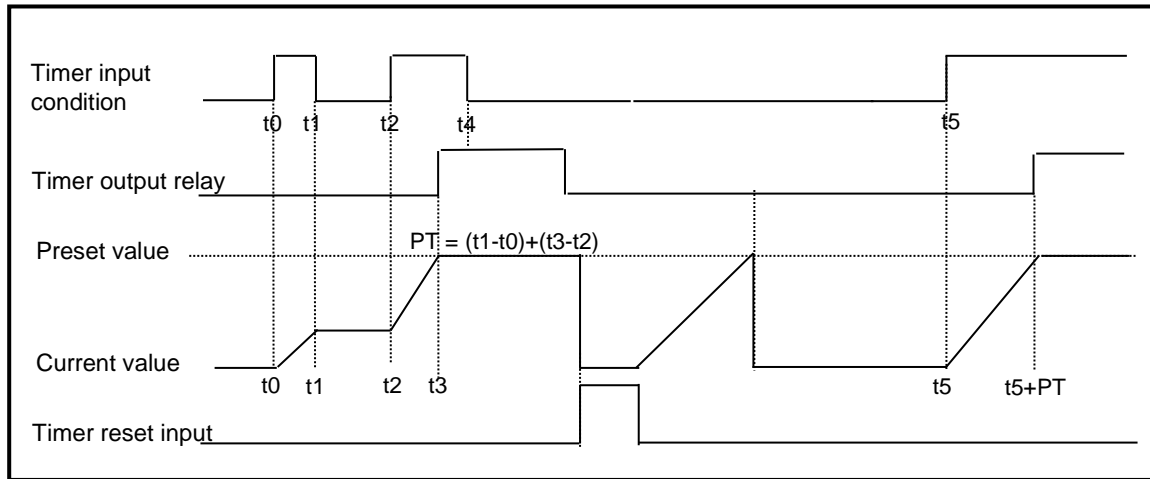

4) Monostable timer

In general, its operation is same as off-delay timer. However, the change of input condition is ignored while the timer is operating (decreasing). When current value reaches preset value the timer output relay is turned off and current value is cleared.

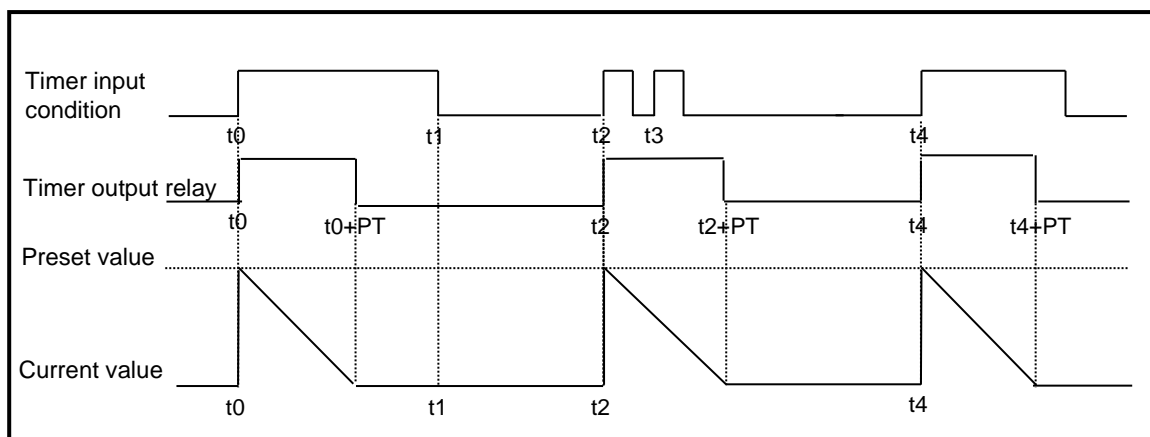

5) Retriggerable timer

The operation of retriggerable timer is same as that of monostable timer. Only difference is that the retriggerable timer is not ignore the input condition of TRTG instruction while the timer is operating (decreasing). The current value of retriggerable timer will be set as preset value whenever the input condition of TRTG instruction is turned on.

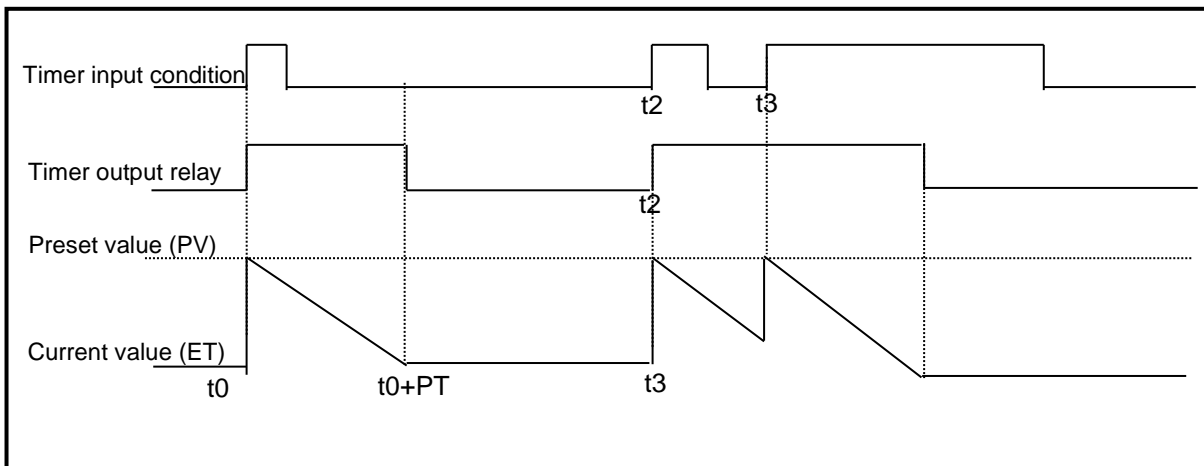

Remark

The Maximum timing error of timers of XGB series is '1 scan time + the time from 0 step to timer instruction'

5.1.6 Counter processing

The counter counts the rising edges of pulses driving its input signal and counts once only when the input signal is switched from off to on. XGB series have 4 counter instructions such as CTU, CTD, CTUD, and CTR. The followings shows brief information for counter operation. Refer to the 'XGB Instruction Manual' for details.

- Up counter increases the current value.
- Down counter decreases the current value.
- Up/Down counter compares the input value from both counters input.
- Ring counter increase the current value and the current value is cleared as 0 when the current value reaches the preset value.

1) Renewal of counter's current value and contact On/Off

(1) Up counter

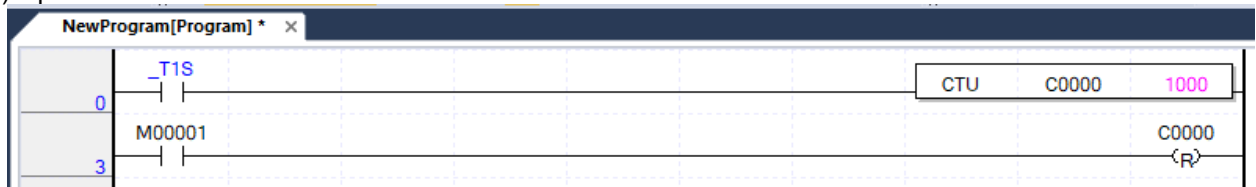

- Up counter increases the current value at the rising edges of input.
- The counter output contact (Cxxx) is turned On when the current value reaches the preset value. When the reset input is turned On, the counter output contact (Cxxx) is turned Off.

(2) Down counter

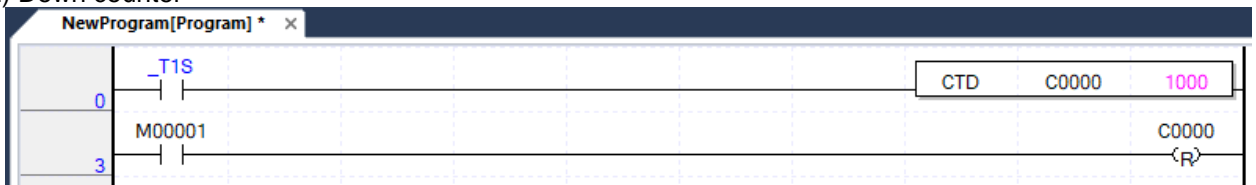

- Down counter decreases the current value at the rising edges of input.
- The counter output contact (Cxxx) is turned On when the current value reaches the preset value. When the reset input is turned On, the counter output contact (Cxxx) is turned Off.

(3) Up/Down counter

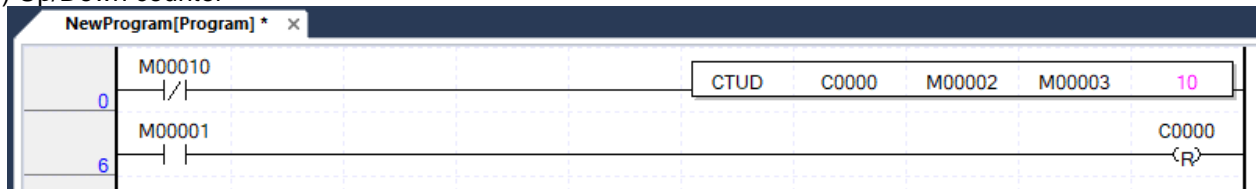

- The current value is increased with the rising edge of up-count input signal, and decreased with the rising edge of down-count input signal. The counter output contact (Cxxx) is turned On when the current value is same as or more than current value. The counter output contact (Cxxx) is turned Off when the current value is same as or less than current value.
- When the reset input is turned On, the current value is cleared as 0.

(4) Ring counter

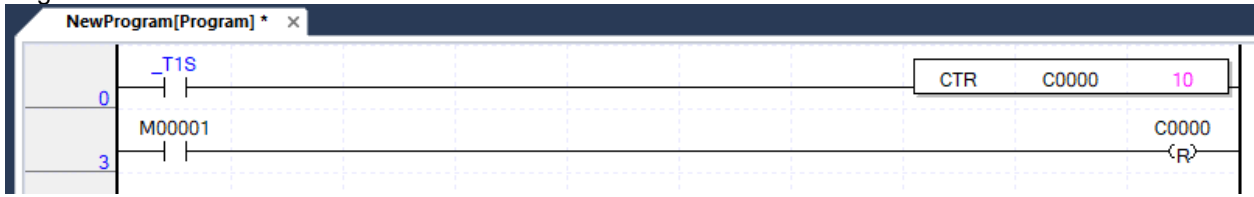

- The current value is increased with the rising edge of the counter input signal, and the counter output contact (Cxxx) is turned on when the current value reaches the preset value. Then the current value and counter output contact (Cxxx) is cleared as 0 when the next rising edge of the counter input signal is applied.
- When the reset input is turned On, the counter output contact is cleared as 0.

2) Maximum counting speed

The maximum counting speed of determined by the length of scan time. Counting is possible only when the on/off switching time of the counter input signal is longer than scan time.

Maximum counting speed $C_{max} = \frac{n}{100} \times \left(\frac{1}{t_s}\right)$

n : duty (%)
 t_s : scan time [s]

- Duty is the ratio of the input signal's on time to off time as a percentage.

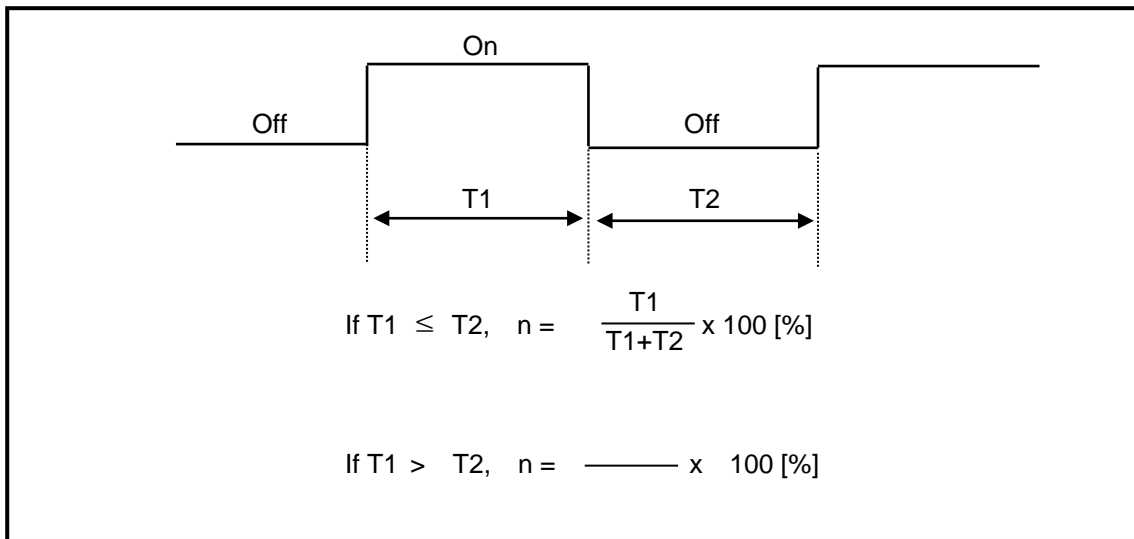

Remark

1) Use of High Speed Counter

In order to counter pulse that is faster than maximum counting speed of normal counter, use built-in High Speed counter function.

5.2 Program Execution

5.2.1 Configuration of program

All functional elements need to execute a certain control process are called as a 'program'. Program is stored in the built-in RAM mounted on a CPU module or flash memory of a external memory module. The following table shows the classification of the program.

Program type	Description
Initializing program	<ul style="list-style-type: none"> It will be executed till the specific Flag 'INIT_DONE' is On. And while the initialization task is executed, several of initializing program is programmed. (If INIT_DONE instruction is executed, scan program is executed.)
Scan program	<ul style="list-style-type: none"> The scan program is executed regularly in every scan.
Cycle time interrupt program	<ul style="list-style-type: none"> The program is performed according to the fixed time interval in case that the required processing time condition is as below. <ul style="list-style-type: none"> In case that the faster processing than 1 scan average processing time is required In case that the longer time interval than 1 scan average processing time is required In case that program is processed with the appointed time interval
External interrupt program	<ul style="list-style-type: none"> The external interrupt program is performed process on external interrupt signal.
Subroutine program	<ul style="list-style-type: none"> Only when some condition is satisfied.(in case that input condition of CALL instruction is On)

5.2.2 Program execution methods

Here describes the program proceeding method that is executed when the power is applied or key switch is 'RUN'. The program performs the operation processing according to the configuration as below.

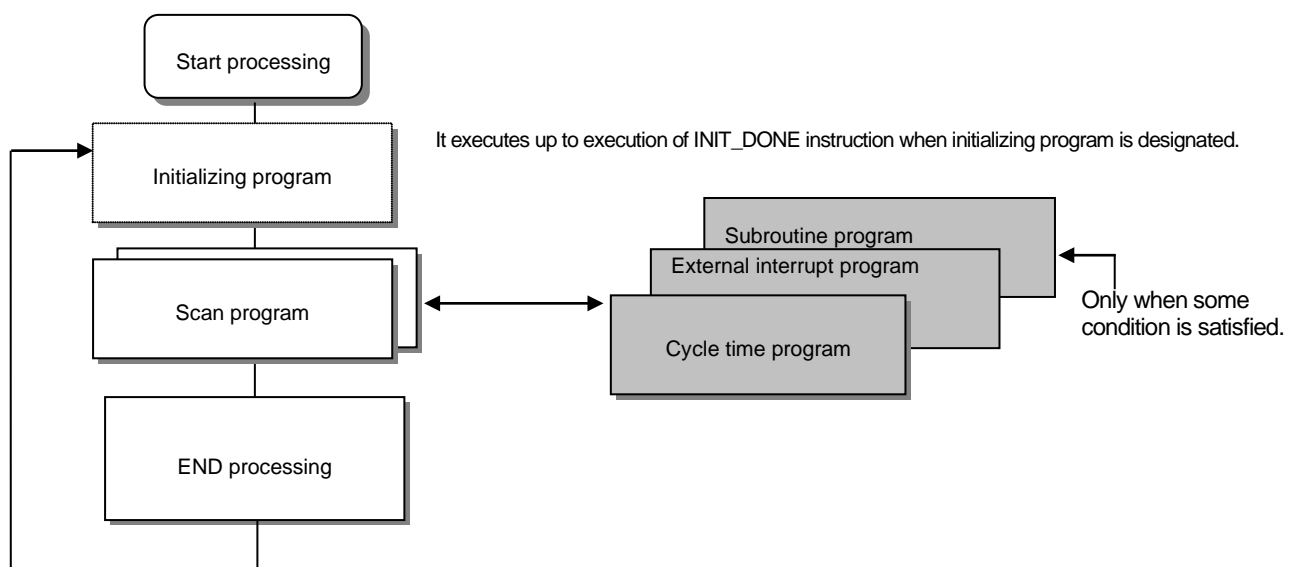

1) Scan program

(1) Function

- This program performs the operation repeatedly from 0 step to last step in order prepared by the program to process the signal that is repeatedly regularly every scan.
- In case that the execution condition of interrupt by task interrupt or interrupt module while executing program is established, stop the current program in execution and perform the related interrupt program.

2) Interrupt program

(1) Function

- This program stops the operation of scan program and then processes the related function in prior to process the internal/external signal occurred periodically/non-periodically.

(2) Type

- Task program is divided as below.
 - ▶ Cycle time task program: available to use up to 8.
 - ▶ Internal device task program: available to use up to 8.
 - ▶ I/O (External contact task program): available to use up to 8. (P000 ~ P007)
- Cycle time task program
 - ▶ Performs the program according to the fixed time interval.
- Internal device task program
 - ▶ Performs the corresponding program when the start condition of internal device occurs.
 - ▶ The start condition detection of device shall be performed after processing of scan program.
- I/O (External contact task program)
 - ▶ Performs the program according to the input external signal (P000~P007).

Remark

- (1) Write the interrupt program as shortly as possible. In case same interrupt occurs repeatedly before completion of interrupt, program is not executed and O/S watch dog error may occur.
- (2) Though interrupt which has lower priority occurs many times during execution of interrupt which has higher priority, interrupt which has lower priority occurs only one time.

5.2.3 Interrupt

For your understanding of Interrupt function, here describes program setting method of XG5000 which is an XGB programming S/W. Example of interrupt setting is as shown bellows.

• Interrupt setting

Interrupt source	Interrupt name	priority	Task No.	Program
Initializing	Interrupt 0_	-	-	-
Cycle time 1	Interrupt 1_cycle time	2	0	Cycle time 1
External	Interrupt 2_external	2	8	External
Internal device	Interrupt 3_internal	3	14	Internal
Cycle time 2	Interrupt 4_cycle time	3	1	Cycle time 2

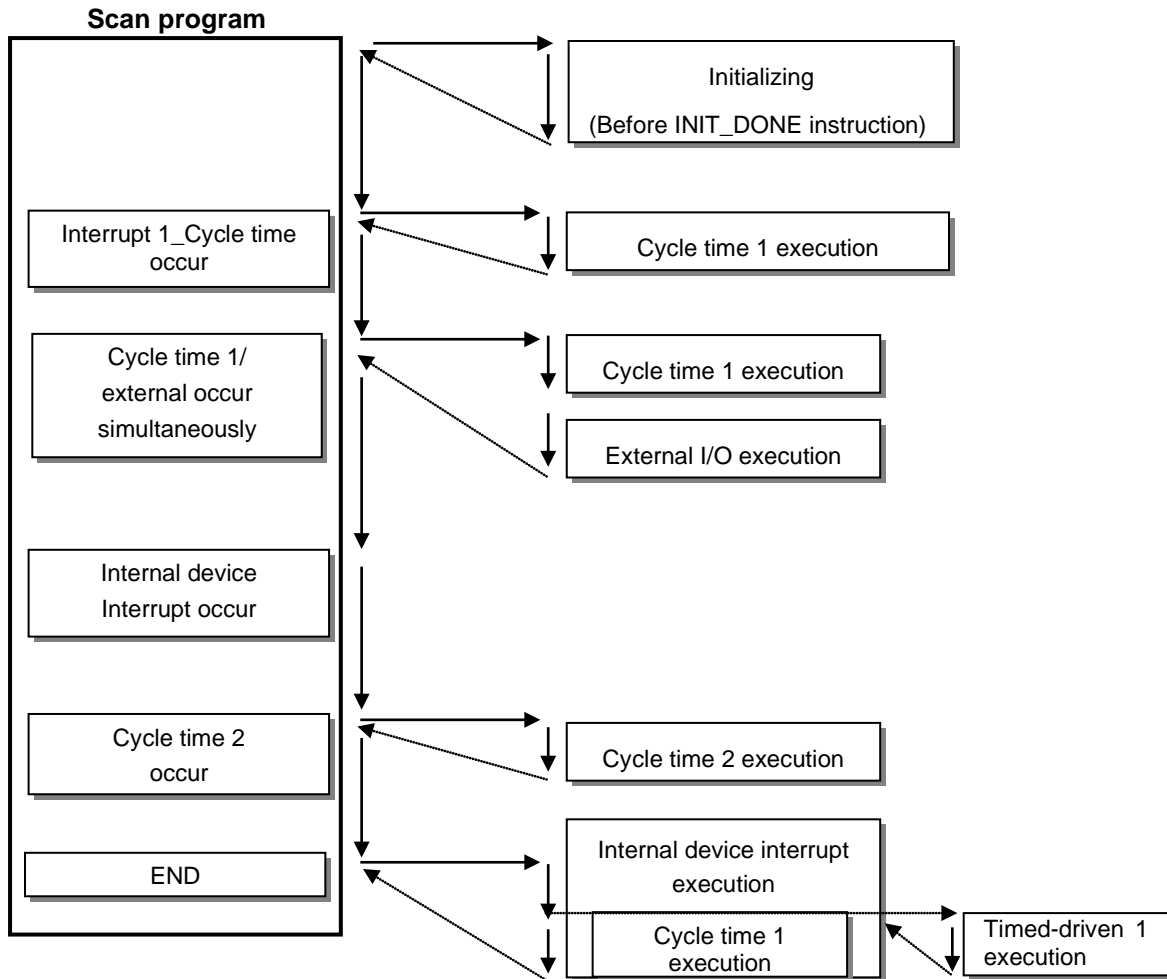

Remark

- In case that several tasks to be executed are waiting, execute from the highest Task Program in priority. When the same priority tasks are waiting, execute from the order occurred.
- While interrupt executing, if the highest interrupt is occurred, the highest interrupt is executed earliest of all.
- When power On, All interrupts are in the state 'Disable'
- Internal device interrupt is executed after END instruction.

1) How to prepare interrupt program

Generate the task in the project window of XG5000 as below and add the program to be performed by each task. For further information, please refer to XG5000 user's manual.

(It can be additional when XG5000 is not connected with PLC.)

- Click right button of mouse on project name and click 『Add item』 - 『Task』 .

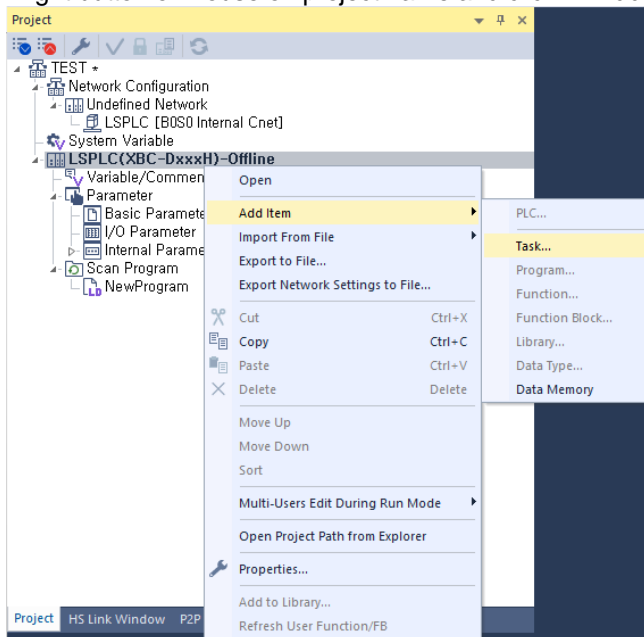

- The screen of Task setting is shown. Click 『Initialization』 in Execution condition and make a Task name.

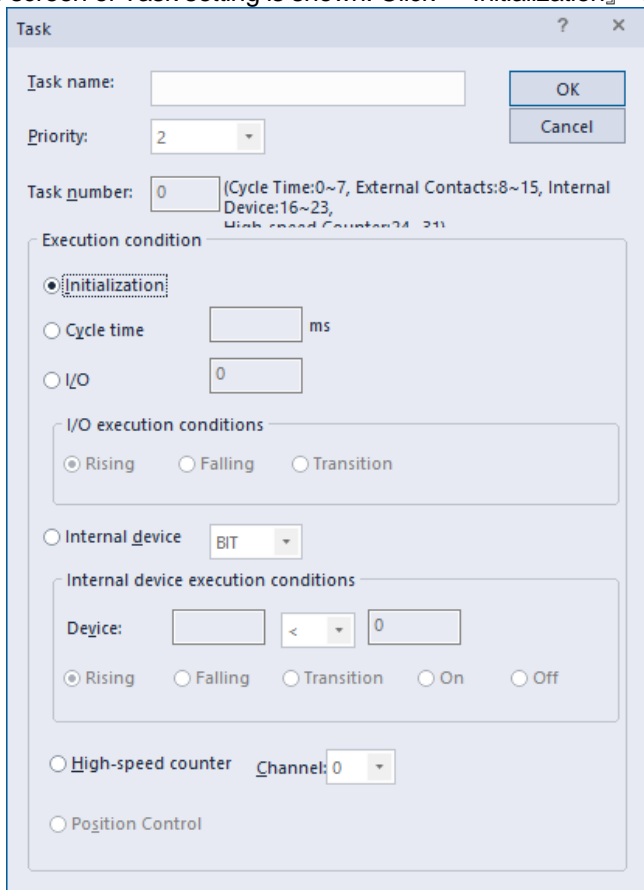

- Click right button of mouse at registered task and select 『Add Item』 - 『Program』 .

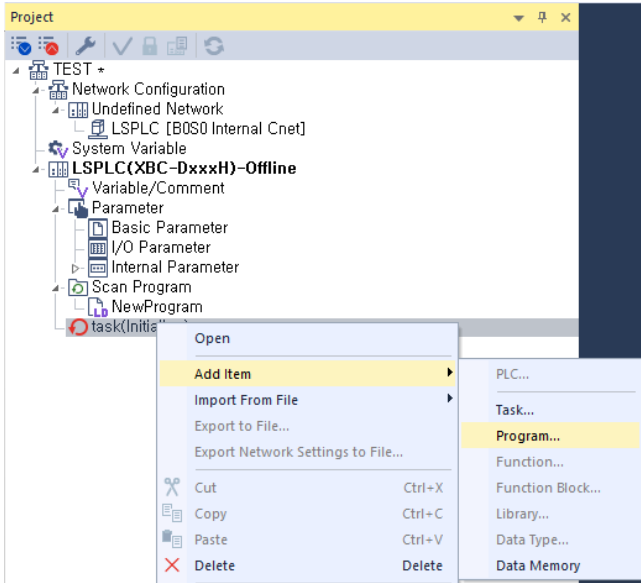

- Make initializing program. In initializing program, INIT_DONE instruction must be made. If not, Scan program is not executed.

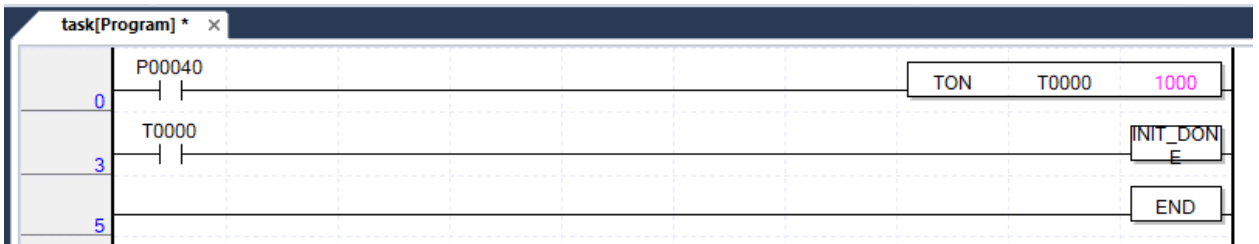

2) How to prepare Cycle interrupt program

Generate the task in the project window of XG5000 as below and add the program to be performed by each task. For further information, please refer to XG5000 user's manual.

(It can be additional when XG5000 is not connected with PLC)

- Click right button of mouse at registered task and select 『Add Item』 - 『Program』 .

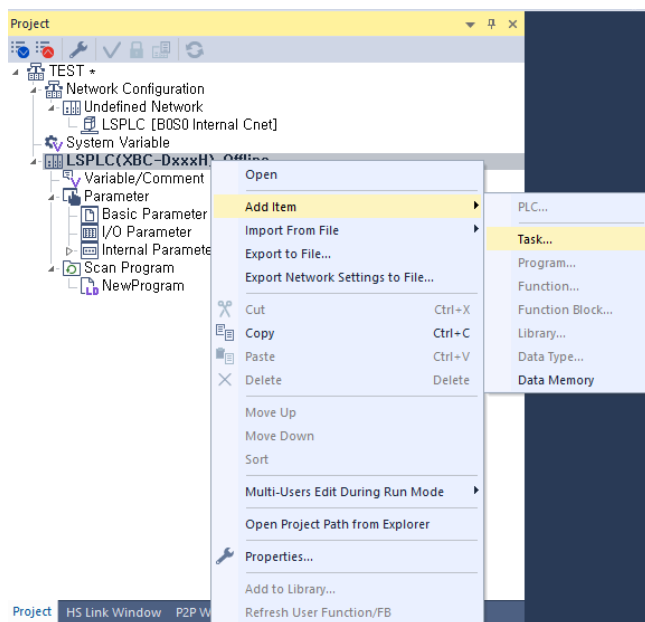

- It shows setting screen of Task.

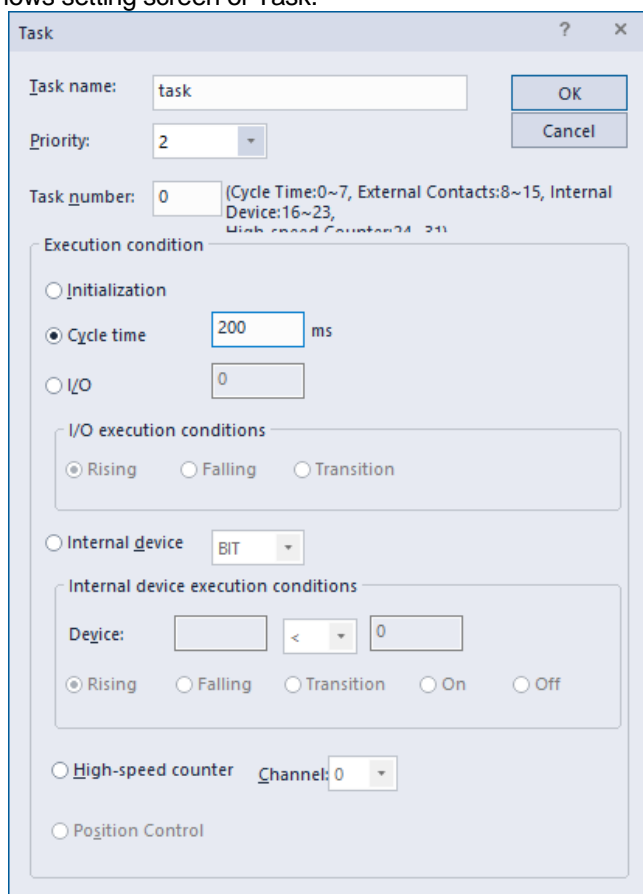

• Task type

Classification		Description	Remark
Task name		Make Task name.	Character, number available
Priority		Set the priority of task. (2~7)	"2" is the highest priority number.
Task number		Set the Task number. <ul style="list-style-type: none"> • Cycle time task (0 ~ 7): 8 • External I/O task (8 ~ 15): 8 • Internal device task (16 ~ 23): 8 	-
Execution condition	Initialization	Set the initial program when running the project.	Till the execution of INIT_DONE instruction
	Cycle time	Set the cyclic interrupt.	0~4294967295 ms available
	I/O	Set the external I/O.	P000 ~ P007 available
	Internal device	Set the internal device to interrupt execution. <ul style="list-style-type: none"> • Bit: Among Rising, Falling, Transition, On, Off • Word: Among >, >=, <, <= 	-

- Click right button of mouse at registered task and select 『Add Item』 - 『Program』 .

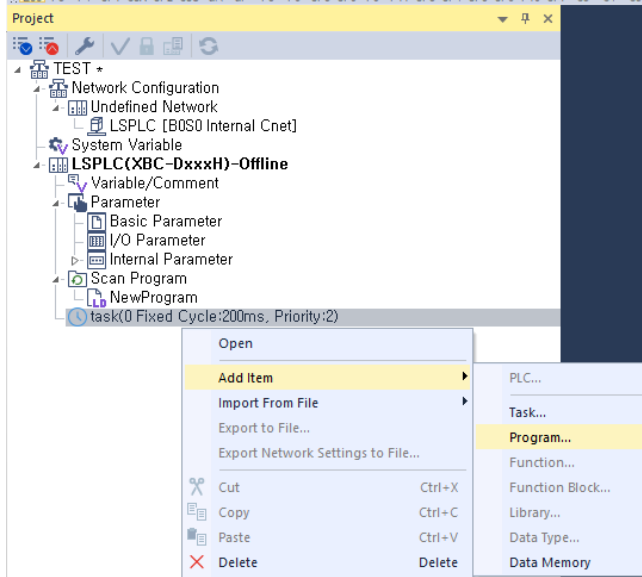

- Register the Program name and Program description.

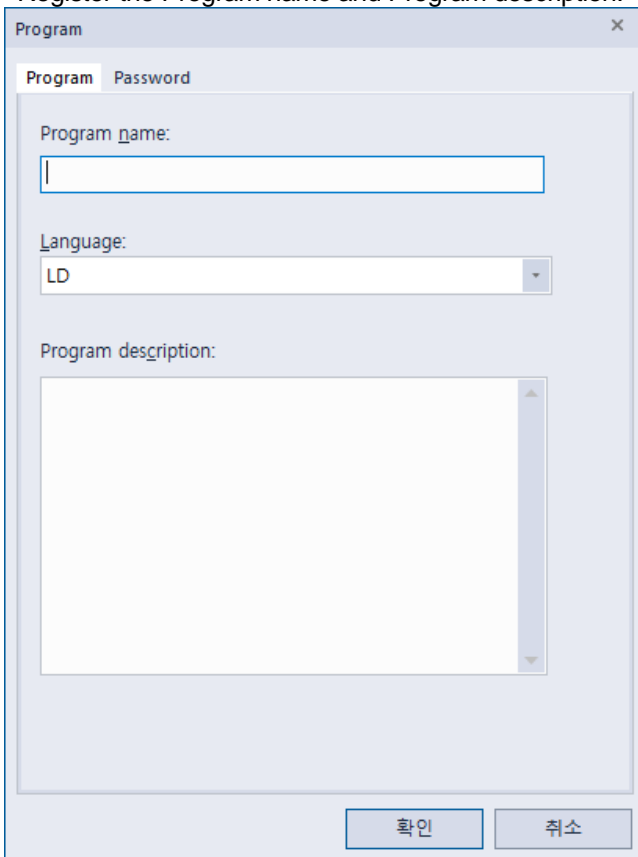

- It is displayed the program window to write task program.

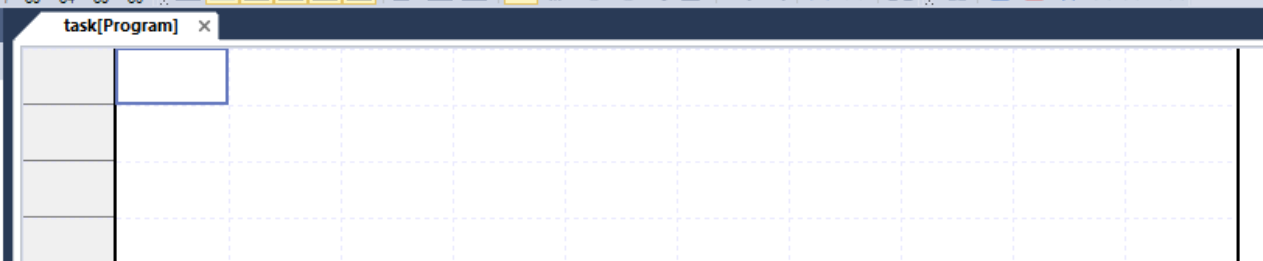

- It is displayed the setting in project window.

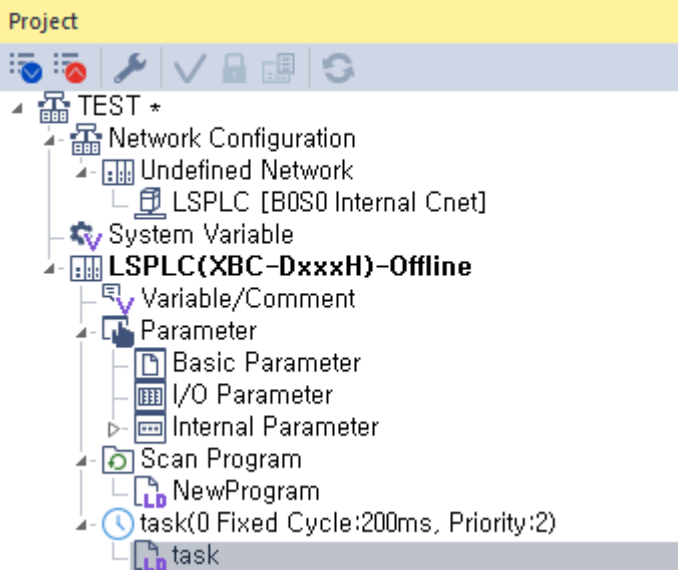

3) Task type

Task type and function is as follows.

Type Spec.	Cycle time task (Interval task)	I/O task (Interrupt task)	Internal device task (Single task)
Max. Task number	8	8	8
Start condition	Cyclic (setting up to max. 4,294,967.295 sec. by 1ms unit)	Rising or falling edge of main unit's contact P000 ~P007	Internal device execution condition
Detection and execution	Cyclic execution per setting time	Immediate execution at the edge of main unit's contact	Retrieve the condition and execute after completing Scan Program
Detection delay time	Max. 1 ms delay	Max. 0.05 ms delay	Delay as much as max. scan time
Execution priority	2~7 level setting (2 level is highest in priority)	2~7 level setting (2 level is highest in priority)	2~7 level setting (2 level is highest in priority)
Task no.	Within 0~7 range without user duplication	With 8~15 range without user duplication	Within 16~23 range without user duplication

4) Processing methods of task program

Here describes common processing method and notices for Task program.

(1) Feature of task program

- Task Program is executed only when execution condition occurs without every scan repeat processing. When preparing Task Program, please consider this point.
- For example, if a timer and counter were used in cyclic task program of 10 second cycle, this timer occurs the tolerance of max. 10 seconds and the counter and the timer and as the counter checks the input status of counter per 10 seconds, the input changed within 10 seconds is not counted up.

(2) Execution priority

- In case that several tasks to be executed are waiting, execute from the highest Task Program in priority. When the same priority tasks are waiting, execute from the order occurred.
- In case Cycle time task and external I/O task is occurred concurrently, execute from the highest task program. (In sequence of XG5000 setting)
- The task program priority should be set considering the program features, importance and the emergency when the execution requested.

(3) Processing delay time

There are some causes for Task Program processing delay as below. Please consider this when task setting or program preparation.

- Task detection delay (Refer to detailed description of each task.)
- Program proceeding delay caused by Priority Task Program proceeding

(4) Relationship of initialize, Scan Program and Task Program

- ser identification task does not start while performing Initialization Task Program.
- As Scan Program is set as lowest priority, if task occurs, stop Scan Program and process Task Program in advance. Accordingly, if task occurs frequently during 1 scan or concentrates intermittently, scan time may extend abnormally. Cares should be taken in case of task condition setting.

(5) Protection of Program in execution from Task Program

- In case that the continuity of program execution is interrupted by high priority Task Program during program execution, it is available to prohibit the execution of Task Program partially for the part in problem. In this case, it is available to perform the program protection by 'DI (Task Program Start Disabled) and 'EI (Task Program Start Enabled)' application instruction.
- Insert 'DI' application instruction in the start position of the part requiring the protection and insert 'EI' application instruction in the position to release. Initialization Task is not influenced by 'DI', 'EI' application instruction.
- If interrupt is occurred while 'CALLP' instruction executing, interrupt program is executed after 'CALLP' instruction execution.

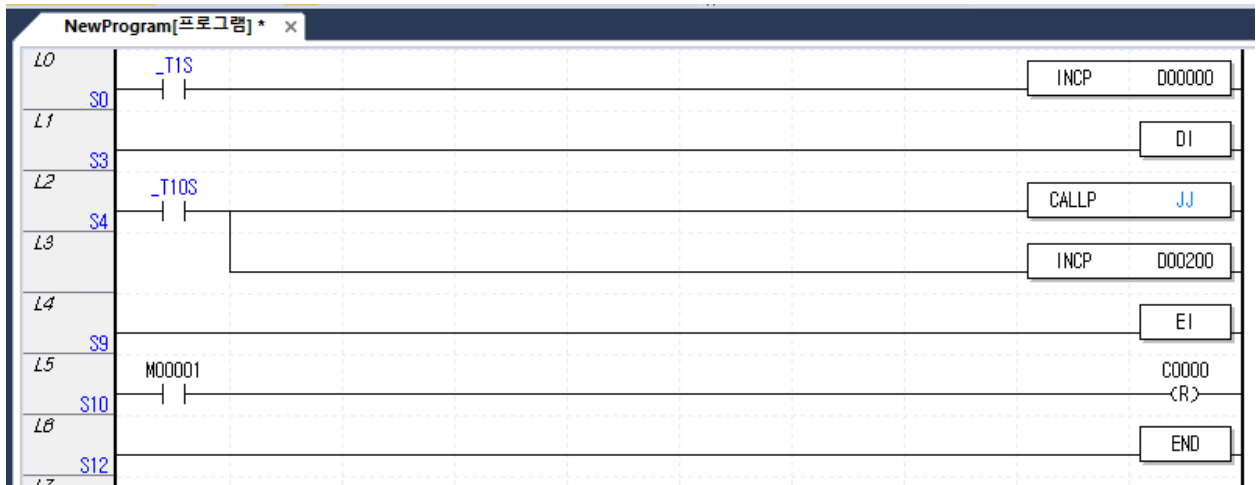

5) Cyclic task program processing method

Here describes the processing method in case that task (start condition) of Task program is set as Cycle time.

(1) Items to be set in Task

- Set the execution cycle and priority which are the start condition of Task program to execution. Check the task no. to manage the task.

(2) Cyclic task processing

- Performance the corresponding cyclic task program per setting time interval (execution cycle).

(3) Notice in using cyclic task program

- When cyclic task program is in execution currently or waiting for execution, if the demand to execute the same task program occurs, the new occurred task shall be disregarded.
- Timer that makes a demand to execute cyclic task program only while operation mode is Run mode, shall be added. The shutdown time shall be all disregarded.
- When setting the execution cycle of cyclic task program, consider the possibility that the demand to execute several cyclic task program at the same time occurs.

If 4 cyclic task programs that the cycle is 2sec, 4sec, 10sec and 20sec are used, 4 demands of execution per 20 seconds shall be occurred at the same time and scan time may extend instantaneously.

Task

Task name:

Priority:

Task number: (Cycle Time:0~7, External Contacts:8~15, Internal Device:16~23, High speed Counter:24~31)

Execution condition

Initialization

Cycle time ms

I/O

I/O execution conditions

Rising Falling Transition

Internal device

Internal device execution conditions

Device: Rising Falling Transition On Off

High-speed counter Channel:

Position Control

6) I/O task program processing

It described the I/O task program processing. (P000 ~ P007)

The screenshot shows a 'Task' configuration window with the following settings:

- Task name:** Cycle
- Priority:** 2
- Task number:** 8 (Cycle Time:0~7, External Contacts:8~15, Internal Device:16~23, High speed Counter:24, 25)
- Execution condition:**
 - Initialization
 - Cycle time: 20 ms
 - I/O: 0
- I/O execution conditions:**
 - Rising
 - Falling
 - Transition
- Internal device:** BIT
- Internal device execution conditions:**
 - Device: [] < 0
 - Rising
 - Falling
 - Transition
 - On
 - Off
- High-speed counter:** Channel: 0
- Position Control

- (1) Items to be set in Task
 - Set the execution condition and priority to the task being executed. Check the task no. to manage the task.
 - (2) I/O task processing
 - If interrupt signal from external signal (I/O) is occurred on main unit (P000 ~ P007), task program is executed by external (I/O) signal.
 - (3) Precaution in using I/O task program
 - If task program which is executed by interrupt signal is on execution or standby status, new task program which is requested by identical I/O is ignored.
 - Only operation mode is Run mode, execution request of task program is recognized. Namely, execution request of task program is ignored when operation mode is Stop mode.
- 7) Internal device task program processing
 Here describes the processing method of international device task program which extended the task (start condition) of task program from contact point to device as execution range.

Task [?] [X]

Task name: [OK] [Cancel]

Priority: [v]

Task number: (Cycle Time:0~7, External Contacts:8~15, Internal Device:16~23, High speed Counter:24, 25)

Execution condition

Initialization

Cycle time ms

I/O

I/O execution conditions

Rising Falling Transition

Internal device

Internal device execution conditions

Device: <

Rising Falling Transition On Off

High-speed counter

Position Control

- (1) Items to be set in Task
 - Set the execution condition and priority to the task being executed. Check the task no. for task management.
- (2) Internal device task processing
 - After completing the scan program execution in CPU module, if the condition that becomes the start condition of internal device task program is met, according to the priority, it shall be executed.
- (3) Precautions in using internal device task program
 - Accordingly, even if the execution condition of internal device task program occurs in Scan Program or Task Program (Cycle time, I/O), it shall not be executed immediately but executed at the time of completion of Scan Program.
 - If the demand to execute Internal Device Task Program occurs, the execution condition shall be examined at the time of completion of Scan Program. Accordingly, if the execution condition of Internal Device Task occurs by Scan Program or Task Program (Cycle time) during '1 scan' and disappears, the task shall not be executed as it is not possible to detect the execution at the time of examination of execution condition.

8) Verification of task program

- (1) Is the task setting proper?

If task occurs frequently more than needed or several tasks occur in one scan at the same time, scan time may lengthen or be irregular. In case not possible to change the task setting, verify max. scan time.
- (2) Is the priority of task arranged well?

The low priority task program shall be delayed by the high priority task program, which results in disabling the processing within the correct time and even task collision may occur as next task occurs in the state that the execution of previous task is delayed. Consider the emergency of task and execution time etc when setting the priority.
- (3) Is the Task Program written in shortest?

If the execution time of Task Program is longer, scan time may lengthen or be irregular. Even it may cause the collision of task program. Write the execution time as short as possible. (Especially, when writing the cyclic task program, write the execution time so that the task program can be executed within 10% cycle of the shortest task among several tasks.)
- (4) Is program protection for the high priority task needed during program execution?

If other task is inserted during task program execution, complete the task in execution and operate the standby tasks in the order of high priority. In case that it is not allowed to insert other task in Scan Program, prevent the insert partially by using 'DI' and 'EI' application instruction. The problem may occur while processing the global variables used commonly with other program or special or communication module.

9) Program configuration and processing example

If task and program are registered as below.

Interrupt type	Interrupt name	Priority	Task No.	Program
Cycle time	10 ms_cycle time	3	0	Program 1
Internal device	Internal device_M00	5	16	Program 2
I/O	I/O_P00	2	8	Program 3

- Scan program name: " Scan Program"
- Execution time respective program: Scan program = 17 ms, Program 1 = 2 ms, Program 2= 7 ms, Program 3 = 2 ms

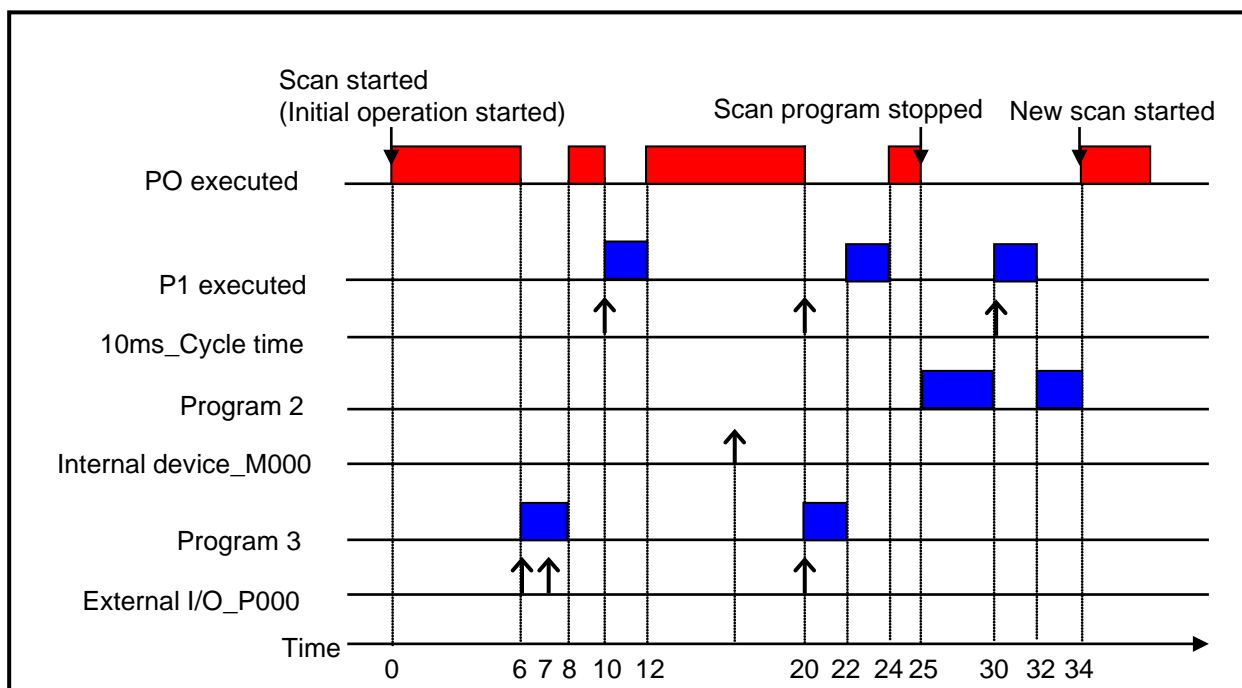

Process per time	
Time (ms)	Process
0	Scan started and scan program started to execute.
0~6	Scan program is executed.
6~8	Scan program is stop because execution external I/O (P000) is requested. And program 3 is executed. Request of execution at 7[ms] is ignored because program 3 has been executing.
8~10	Program 3 is finished and Scan program is continued.
10~12	Scan program is stop by request of '10 ms_Cycle time' interrupt signal and execute program 1.
12~20	Program 1 is finished and Scan program is continued.
20	Request of 'Cycle time' interrupt signal and 'External I/O (P000)' signal is occurred concurrently but priority of 'External I/O' signal is higher than 'Cycle time' interrupt signal so program 3 is executed and program 1 is standby.
20~22	Program 3 is finished and Scan program is continued.
22~24	After program 3 is completed, program 1 (the program of '10ms_Cycle time' is executed.
24~25	P1 execution completed and the stopped scan program execution finished

25	At the finished point of scan program, check the request of Internal device 'M000' execution and execute program 2.
25~30	Program P2 is executed.
30~32	When '10 ms_Cycle time' interrupt signal is occurred, the priority of that is higher than Internal device 'M000' though program 2 is stopped and program 1 is executed.
32~34	P1 executed completed and the stopped P2 execution finished
34	New scan starts (Start scan program execution)

5.3 Operation Mode

For operation mode of CPU module, there are 3 types such as RUN mode, STOP mode and DEBUG mode.. Here describes the operation processing of each operation mode.

5.3.1 RUN mode

This is the mode to executed program operation normally.

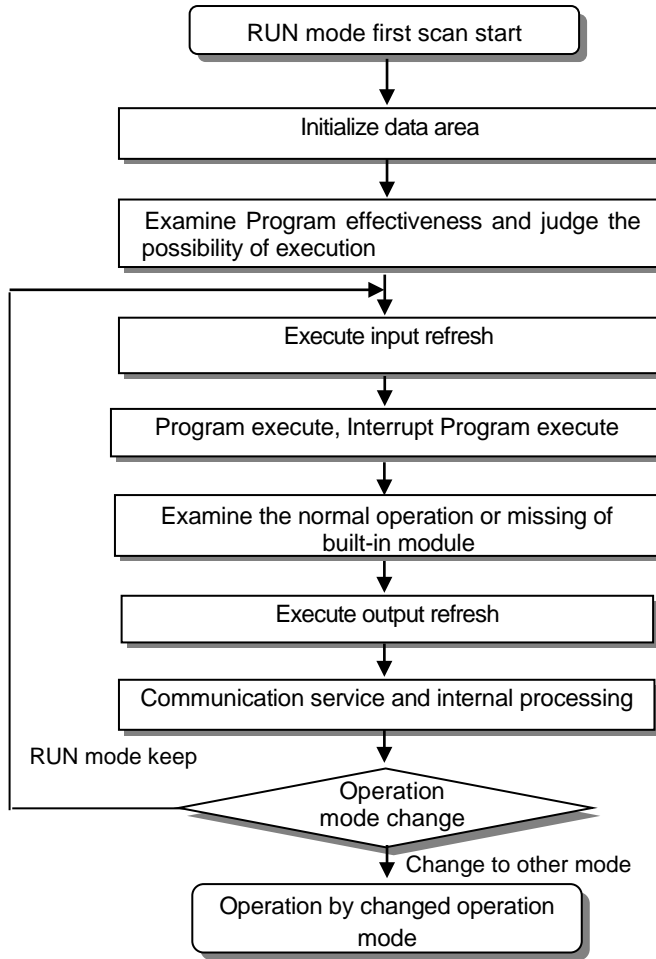

1) Processing at mode change

At the beginning, execute initialization of data area and examine the effectiveness of program and judge the possibility of execution.

2) Operation processing contents

Execute I/O refresh and program operation.

- (1) Detects the start condition of Interrupt Program and executes Interrupt Program.
- (2) Examines the normal operation or missing of built-in module.
- (3) Communication service and other internal processing.

5.3.2 STOP mode

This is the mode in stop state without Program operation. It is available to transmit the program through XG5000 only in Remote STOP mode.

- 1) Processing at Mode Change
 - Clear the output image area and execute output refresh.
- 2) Operation Processing Contents
 - (1) Executes I/O refresh.
 - (2) Examines the normal operation or missing of built-in module.
 - (3) Communication service or other internal processing.

5.3.3 DEBUG mode

This is the mode to detect Program error or trace the operation process and the conversion to this mode is available only in STOP mode. This is the mode to check the program execution state and the contents of each data and verify the program.

- 1) Processing at mode change
 - (1) Initializes the data area at the beginning of mode change.
 - (2) Clears the output image area and execute input refresh.
- 2) Operation processing contents
 - (1) Executes I/O refresh.
 - (2) Debug operation according to setting state.
 - (3) After finishing Debug operation by the end of Program, execute output refresh.
 - (4) Examine the normal operation or missing of built-in module.
 - (5) Executes communication service or other service.
- 3) Debug operation
 - It describes debug mode.

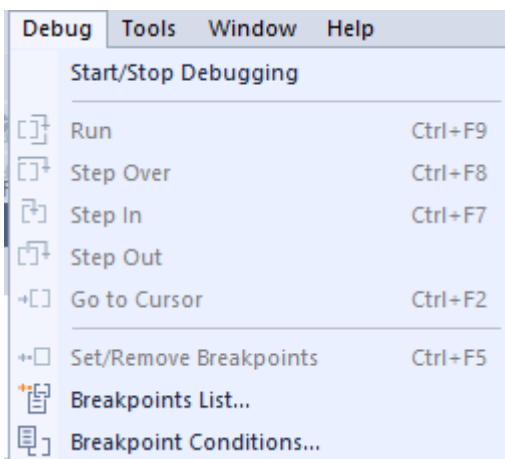

Chapter 5. Program Configuration and Operation Method

Item	Description	Remark
Start/Stop Debugging	Change the debug ↔ stop mode	
Go	It starts debug operation.	
Step Over	It operates by 1 step.	
Step Into	It starts the subroutine program.	Other operation is identical to Step Over.
Step Out	It finished the subroutine program.	
Go to Cursor	It operates to current cursor position.	
Set/Remove Breakpoints	Set/Removes current cursor position to break points.	
Breakpoints List	It displays list of breakpoints.	
Breakpoint Conditions	It specifies device value and number of scan.	

(1) Set/Remove Breakpoints

- Sets breakpoint at current cursor position. After breakpoint setting,  (breakpoint setting indicator) is displayed.

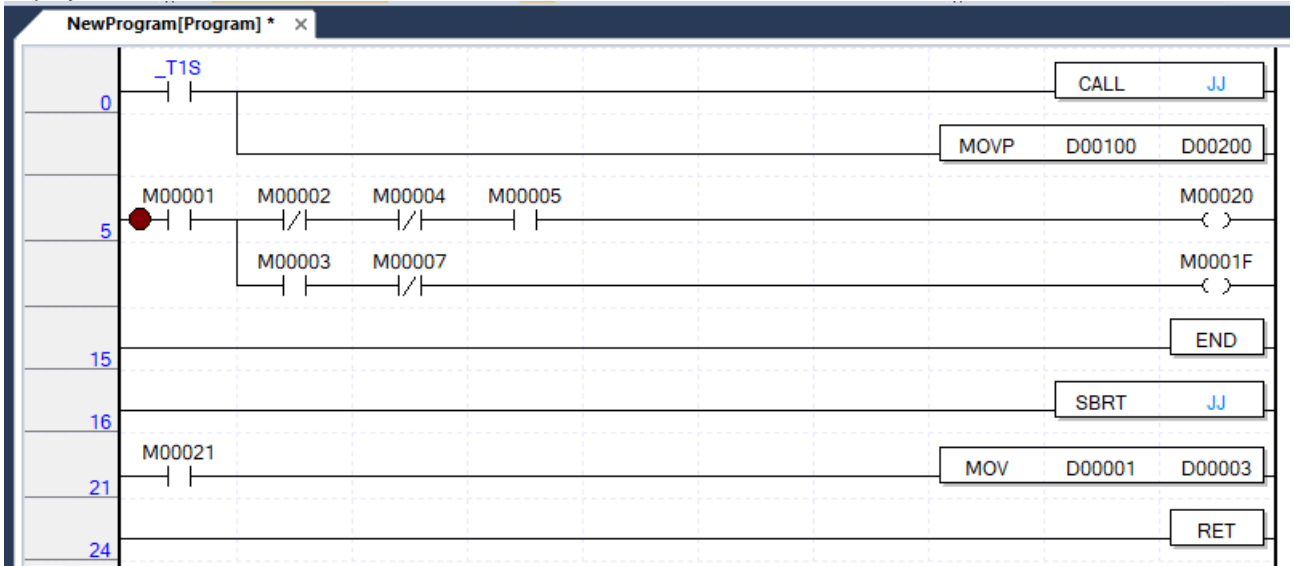

(2) Go

- Run the program to breakpoint. At breakpoint -  (stop indicator) is displayed.

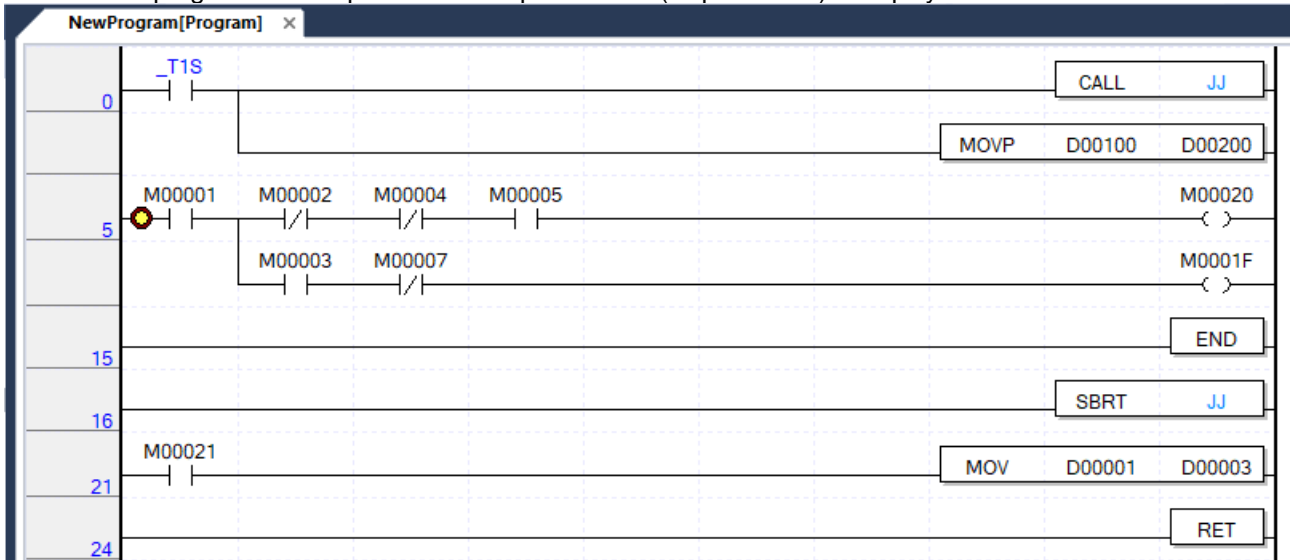

(3) Step Over

- Run the program to next step. At break point, Step over indicator  is displayed.

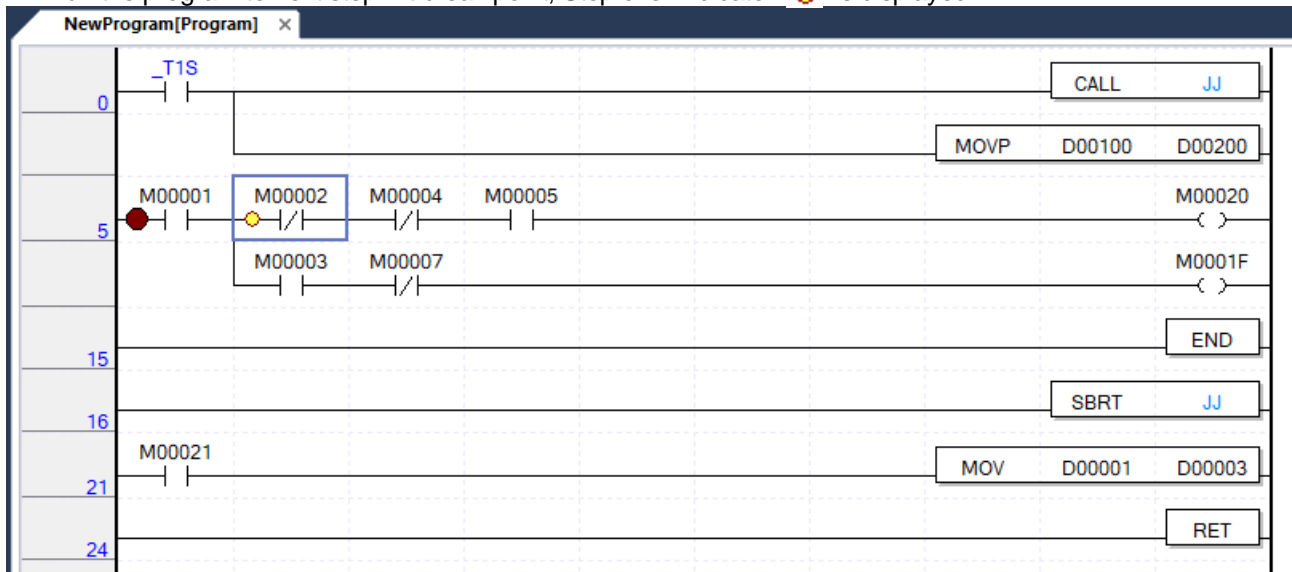

(4) Breakpoint List

- It displays current Breakpoint List. It supports Select All, Reset All, Goto, Remove, Remove All.

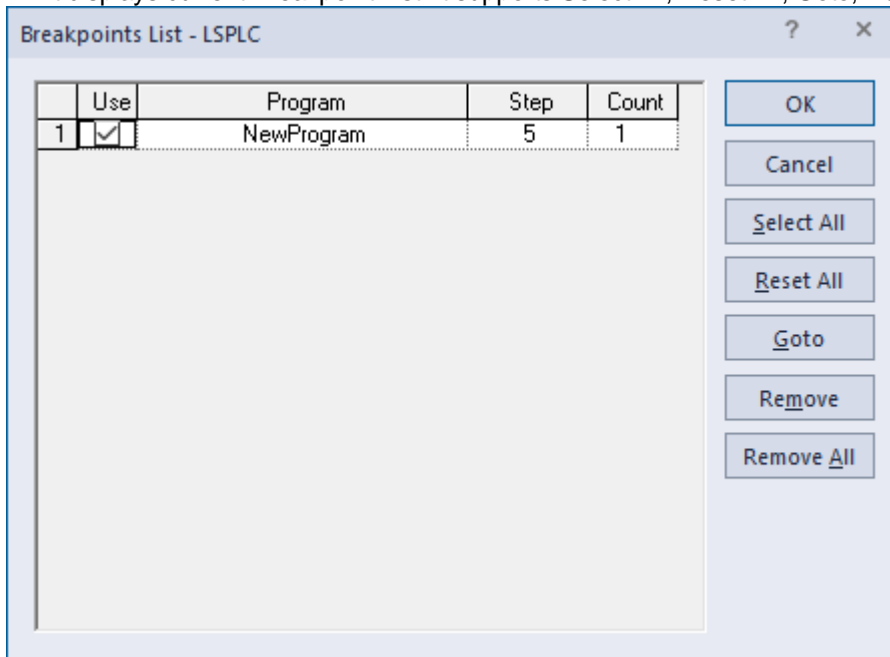

(5) Break condition

- It sets Device Break and Scan Break.

The screenshot shows the 'Break condition - LSPLC' dialog box with the 'Variable Breakpoint' tab selected. The 'Use the device as a variable breakpoint.' checkbox is checked. The 'Device' field contains 'D000', the 'Type' dropdown is set to 'WORD', and the 'Variable' and 'Comment' fields are empty. A 'Value Condition' checkbox is also checked, with the 'Value' field containing 'H1234'. A 'Select Variable...' button is located to the right of the 'Device' field. At the bottom, there are '확인' (OK) and '취소' (Cancel) buttons.

The screenshot shows the 'Break condition - LSPLC' dialog box with the 'Scan Breakpoint' tab selected. The 'Use Scan Breakpoint' checkbox is checked. Below it, the text reads 'Debugger stops after scanning following counts.' The 'Scan Count' field is a spinner box set to '6000', followed by the text 'times'. At the bottom, there are '확인' (OK) and '취소' (Cancel) buttons.

Remark

- Refer to XG5000 Users Manual 'Chapter 12 Debugging' for detailed information.

5.3.4 Change operation mode

1) Operation Mode Change Method

The method to change operation mode are as follows.

- (1) By mode key of CPU module
- (2) By connecting the programming tool (XG5000) to communication port of CPU
- (3) By changing the operation mode of other CPU module connected to network by XG5000 connected to communication port of CPU.
- (4) By using XG5000, HMI, computer link module connected to network
- (5) By 'STOP' instruction during program execution

2) Type of operation mode

The operation mode setting is as follows.

Operation mode switch	XG5000 command	Operation mode
RUN	X	Run
STOP	RUN	Remote Run
	STOP	Remote Stop
	Debug	Debug Run
	Mode change	Previous operation mode
RUN -> STOP	-	Stop

- (1) Remote mode conversion is available only in the state of '**Remote Enabled: On**', '**Mode switch: Stop**'.
- (2) In case of changing the Remote 'RUN' mode to 'STOP' by switch, operate the switch as follows.
(STOP) → RUN → STOP .



Warning

In case of changing Remote RUN mode to RUN mode by switch, PLC operation continues the operation without interruption.

It is available to modify during RUN in RUN mode by switch but the mode change operation by XG5000 is limited. This should be set only in case that remote mode change is not allowed.

5.4 Memory

There are two types of memory in CPU module that the user can use. One is Program Memory that saves the user program written by the user to build the system, and the other is Data Memory that provides the device area to save the data during operation.

5.4.1 Data memory

1) Bit device area

Various Bit Device are provided per function. The indication method is indicated by device type for first digit, word position by decimal for middle digit and bit position by hexadecimal for the last digit.

Area per device		Device features	Description
"S" type	"H" type		
P0000 ~ P127f	P0000~ P1023f	I/O device "P"	Image area to save the state of I/O device. After reading the input module state, saves it in the corresponding P area and sends P area Data saving the operation result to output module.
M0000 ~ M255f	M0000~ M1023f	Internal device "M"	Internal Memory provided to save Bit Data in Program
L0000 ~ L1279f	L0000~ L2047f	Communication device "L"	Device to indicate high speed link/P2P service state information of communication module.
K00000 ~ K2559f	K00000~ K4095f	Preservation device "K"	Device area to preserve the data during power shutdown, which is used without setting power shutdown preservation parameter separately. (Pay attention to write in special area (K2600 ~ 2559F)).
F0000 ~ F255f	F0000~ F1023f	Special device "F"	System flag area that manages the flag necessary for system operation in PLC.
T0000 ~ T255	T0000~ T1023	Timer device "T"	Area to save the state of contact/current value/set value of timer device
C0000 ~ C255	C0000~ C1023	Counter device "C"	Area to save the state of contact/current value/set value of counter device
S00.00 ~ S127.99	S00.00~ S127.99	Step controller "S" 128 x 100 step	Relay for step control

2) Word device area

Area per device		Device features	Description
"S" type	"H" type		
D00000 ~ D5119	D0000~ D10239	Data register "D"	Area to preserve the internal data. Bit expression possible. (D0000.0)
U00.00 ~ U07.31	U00.00~ U0A.31	Analog data register "U"	Register used to read data from special module installed in the slot. Bit expression possible
N0000 ~ N3935	N0000~ N5119	Communication data register "N"	P2P Service Save area of communication module. Bit expression impossible
Z000 ~ Z127	Z000~ Z127	Index register "Z"	Dedicated device to use Index function Bit expression impossible
T0000 ~ T255	T0000~ T1023	Timer current value register "T"	Area to indicate the current value of timer
C0000 ~ C255	C0000~ C1023	Counter current value register "C"	Area to indicate the current value of counter
-	R0000~ R10239	File register "R"	Register for saving the file

5.5 Configuration Diagram of Data Memory

5.5.1 "S" type

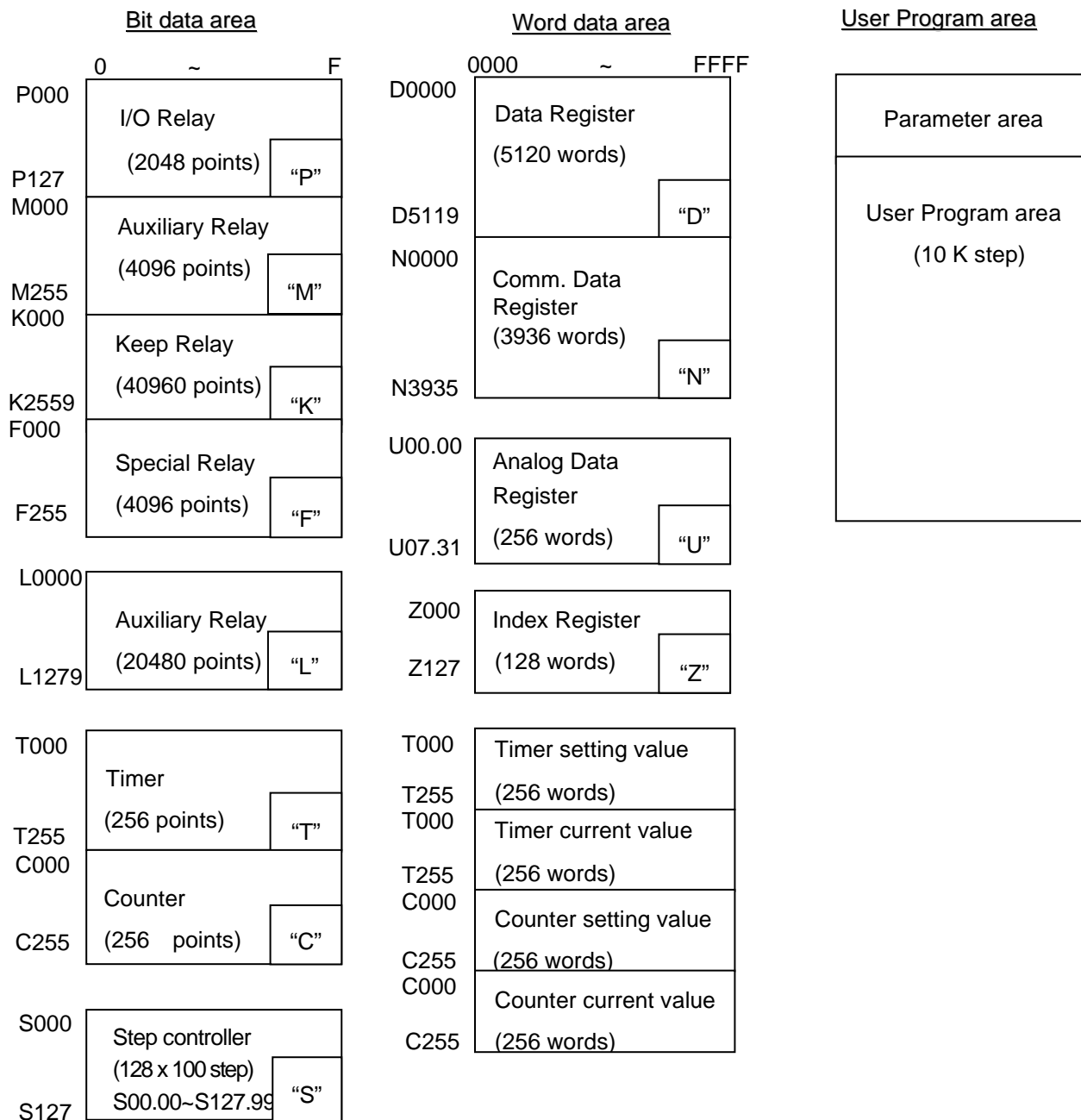

5.5.2 “H” type

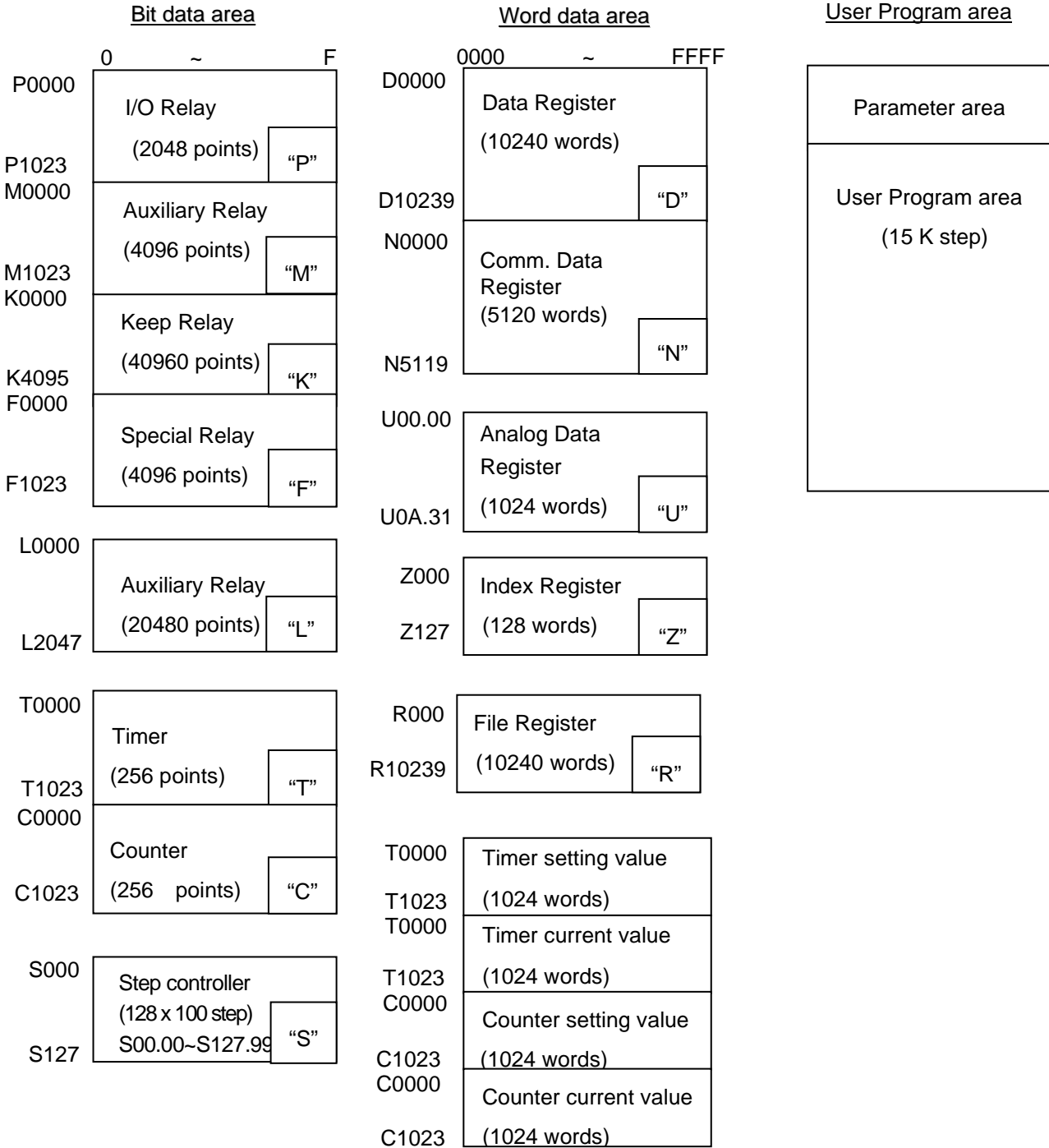

5.5.3 Data latch area setting

When PLC stops and restarts the data required for operation or the data occurred during operation, if you want to keep and use those data, data latch can be used and it is available to use a certain area of some data device as latch area by parameter setting.

The below shows the features for latch device.

Device	1 st latch	2 nd latch	Features
P	X	X	Image area to save the state of I/O device
M	O	O	Internal device area
K	X	X	Device keeping the device state during power shutdown
F	X	X	System flag area
T	O	O	Timer related area (Bit/words both)
C	O	O	Counter related area (Bit/words both)
S	O	O	Relay for step control
D	O	O	General words data save area
U	X	X	Analog Data Register (latch disabled)
L	X	X	High speed link/P2P Service state device of communication module (latch enabled)
N	X	X	P2P Service address area of communication module (latch enabled)
Z	X	X	Index dedicated Register (latch disabled)
R	X	X	File register (latch enabled)

Remark

- K, L, N, R devices are basically latched.

1) Latch area setting

- Click Device Area Setup of Basic parameter settings.

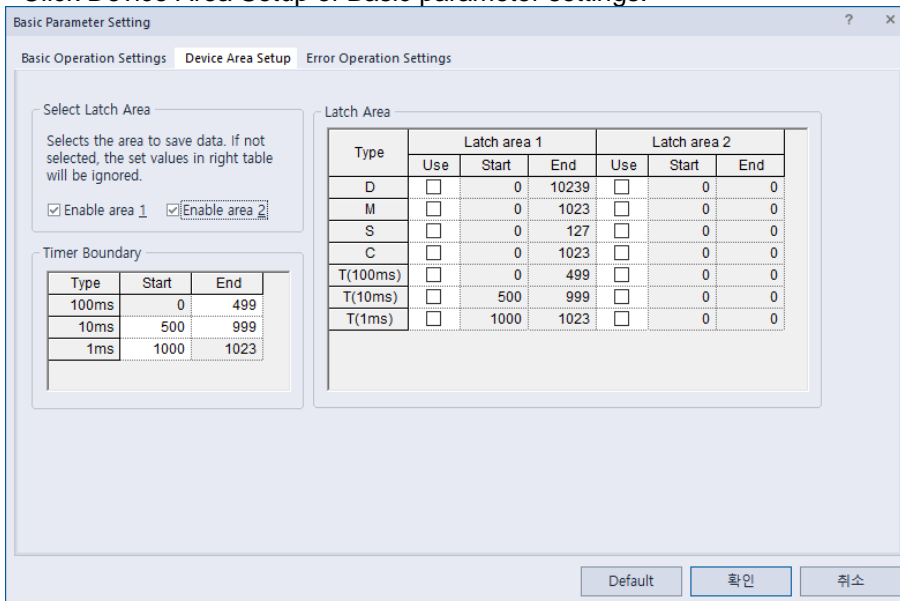

2) Data latch area operation

The method to delete the latched data is as below.

- latch 1, latch 2 clear operation by XG5000
- write by Program (initialization program recommended)
- write '0' FILL from XG5000 monitor mode.

For keep or reset (clear) operation of latch area data according to PLC operation, please refer to the below table.

No.	Classification	Detailed operation	Latch 1	Latch 2
1	Power change	Off/On	Keep	Keep
2	Reset by XG5000	Overall reset	Reset	Keep
3	Program write (online)	-	Keep	Keep
4	Data broken	SRAM broken by battery error	Reset	Reset
		Data broken by other reason	Reset	Reset
5	XG5000 online	Clear Latch 1	Reset	Keep
		Clear Latch 2	Reset	Reset

▪ Latch 1 area is cleared by 『Online』 - 『Reset PLC』 - “Overall reset”.

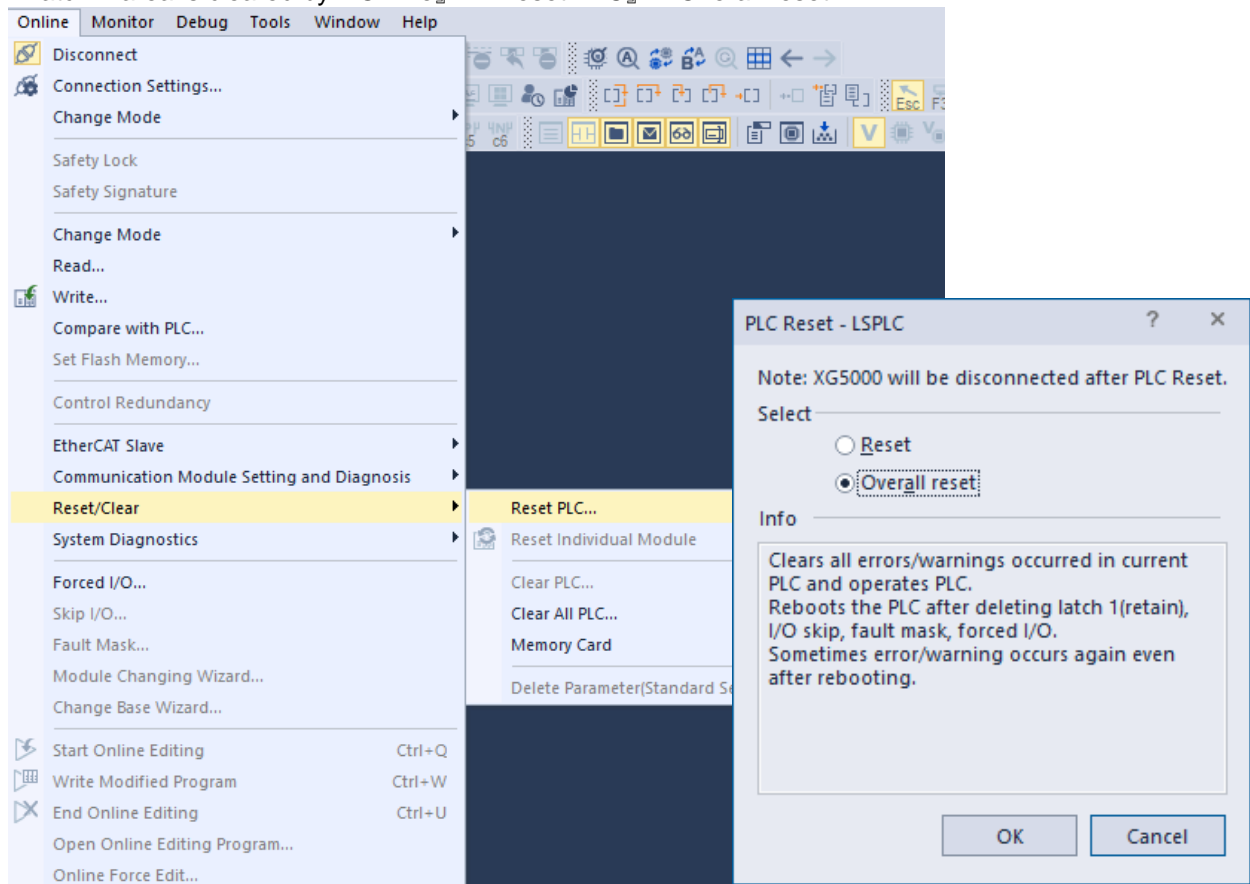

- Latch 1, 2 area is cleared by 『Online』 - 『Clear PLC』 .

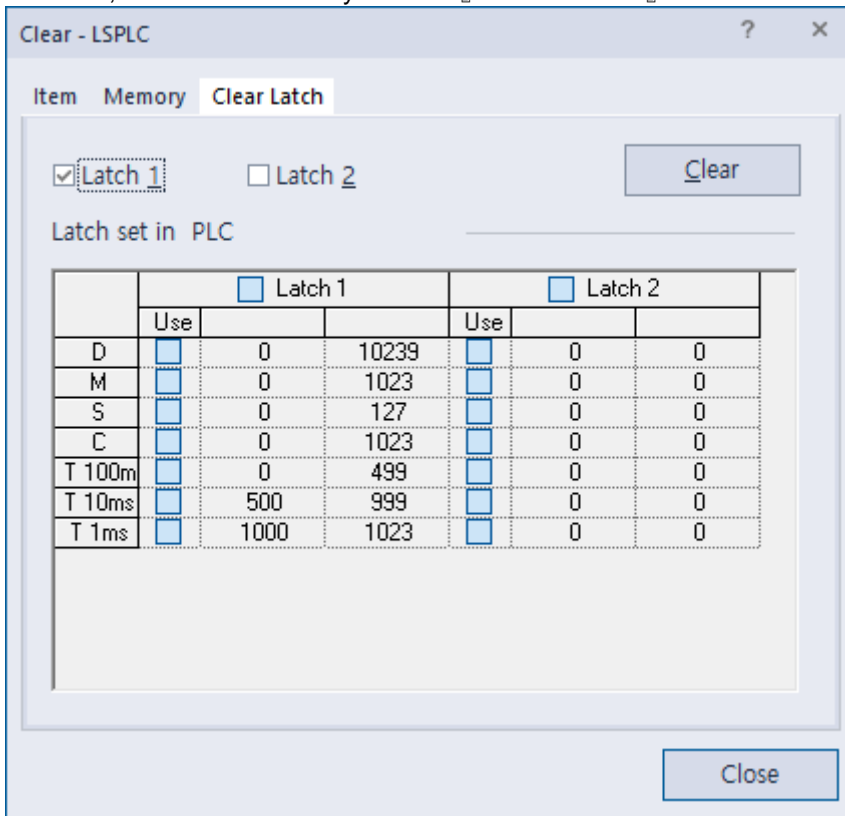

3) Data initialization

In case of Memory Delete state, the memory of all device shall be cleared as '0'. In case of giving the data value at the beginning according to system, please use the initialization task.

Device area is cleared by click 'Clear' in 『Online』 - 『Clear PLC』 - 『Clear Memory』 .

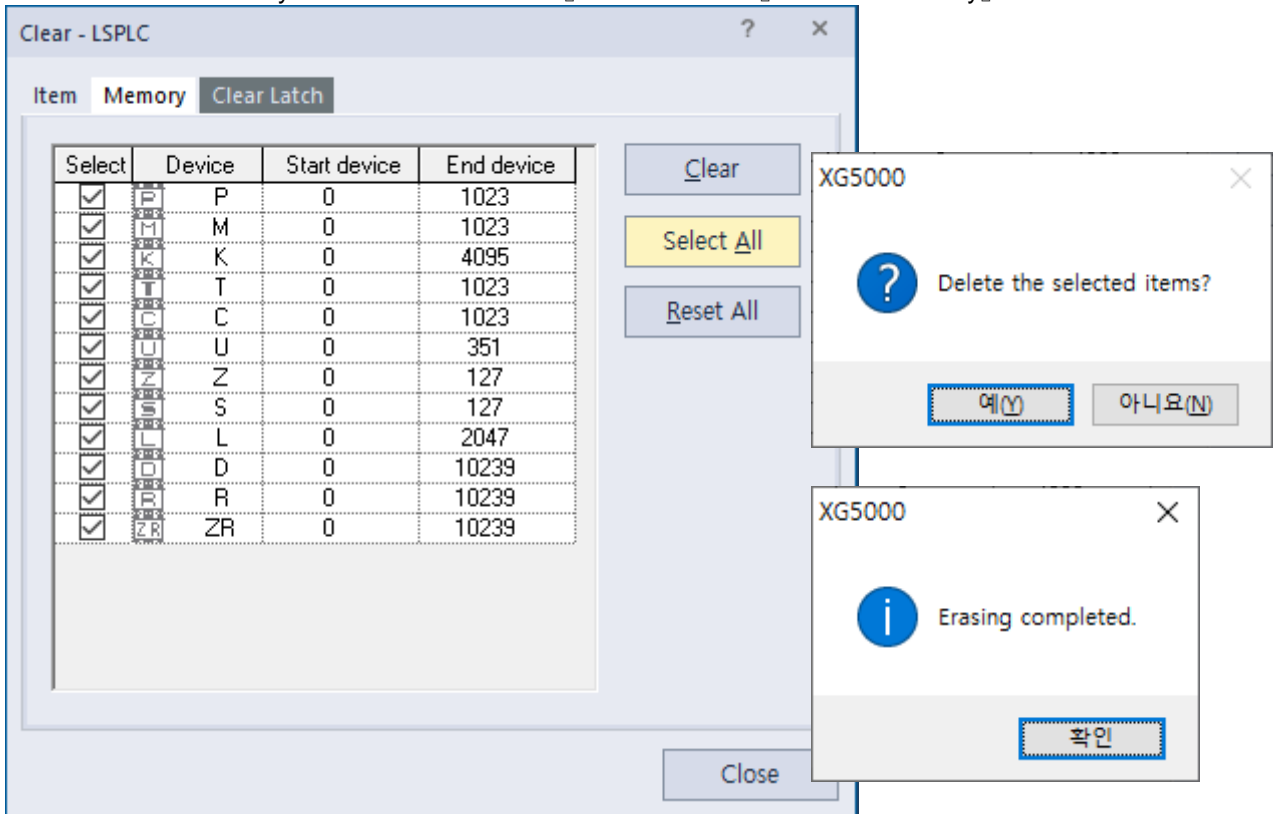

Chapter 6 CPU Functions

6.1 Type Setting

It describes setting of XGB PLC type.

PLC Series	CPU type	Description	Reference
XGB	XGB-XBMS	“S” type : XBM-DN16/32S , XBM-DR16S	Module type
	XGB-XBCH	“H” type : XBC-DR32/64H , XBC-DN32/64H	Compact type

Remark

- In case type is different, connection is not available.

6.2 Parameter Setting

This paragraph describes how to set parameters.

6.2.1 Basic parameter setting

Clicking Basic Parameter in the project window shows the following window.

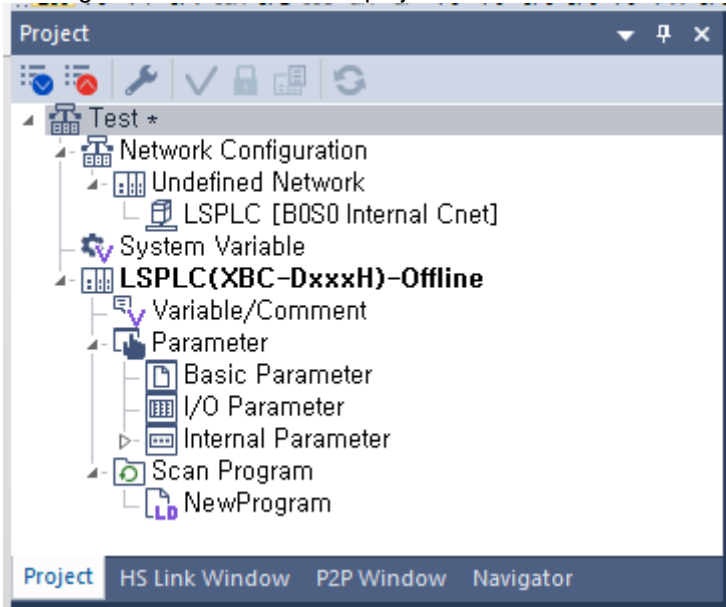

There are three main options ; “Basic Operation Setup” , “Device Area Setup” and “Error Operation Setup”.

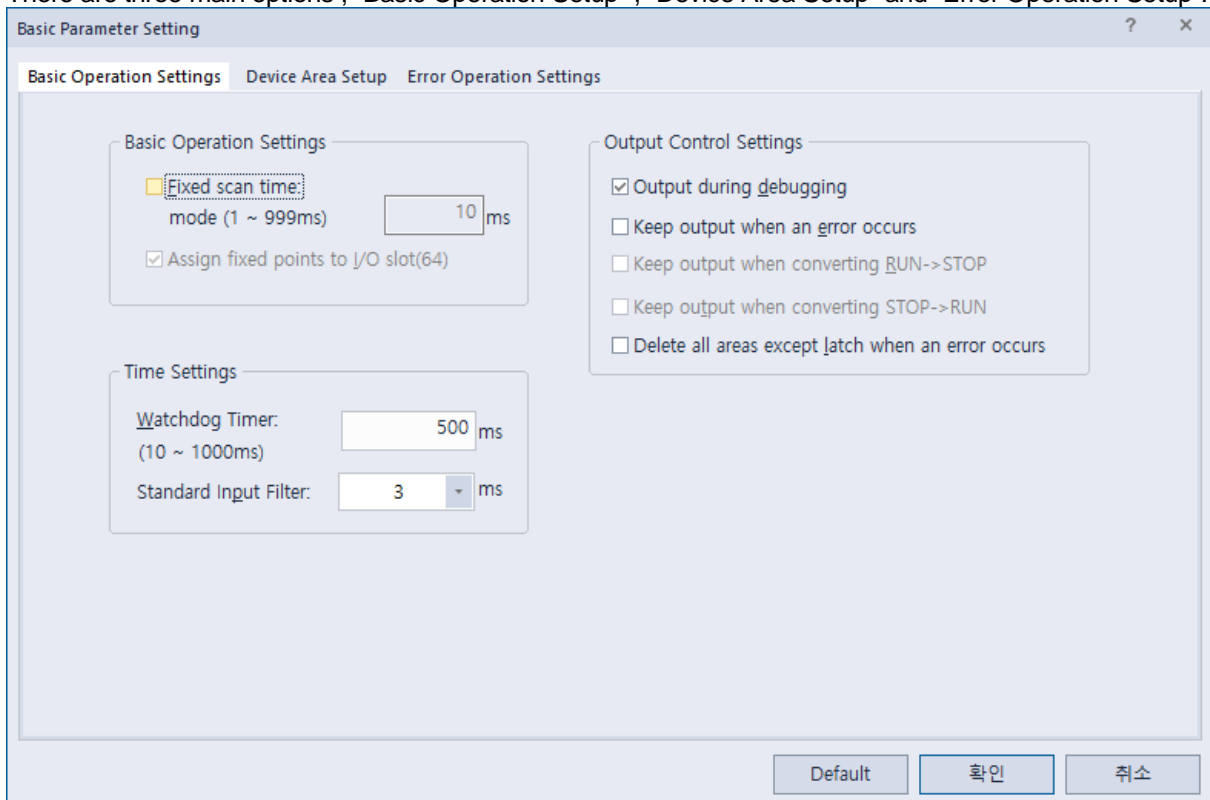

Category	Item	Description	Note
Basic operations	Fixed period operation	Set the time of fixed period operation.	1~999 ms
	Watchdog timer	Set the time of scan watchdog.	10~1000 ms
	Standard input filter	Set the time of standard input filter.	1,3,5,10,20,70,100 ms
	Output during debugging	Set whether to allow output actually during debugging operation.	Allowance/Prohibition
	Keep output when an error occurs	Set whether to preserve output holding function set in I/O parameter in case of error.	Allowance/Prohibition
	Delete all areas except latch when an error occurs	Set whether to clear each device that is not designated as a latch area in case of error	Allowance/Prohibition
Device area	Select latch area	Set the latch area of each device.	-
Error operation	Operation resumes in case of operation error	Set whether to pause or resume operation in case of operation error.	Pause/Resume

6.2.2 I/O parameter setting

This setting is to set and reserve each I/O information. Clicking 『I/O Parameter』 in the project window shows the following setting window.

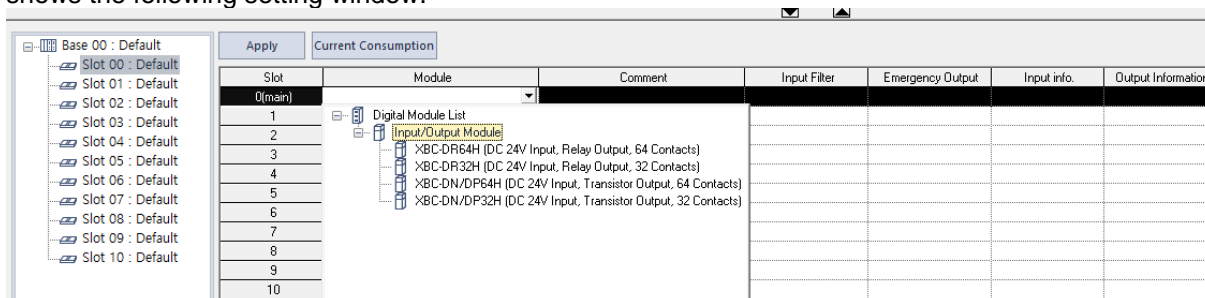

Clicking 『Module』 in 『Slot Position』 indicates a list of modules, in which you may set I/O corresponding to the actual system. Then, the following window is displayed.

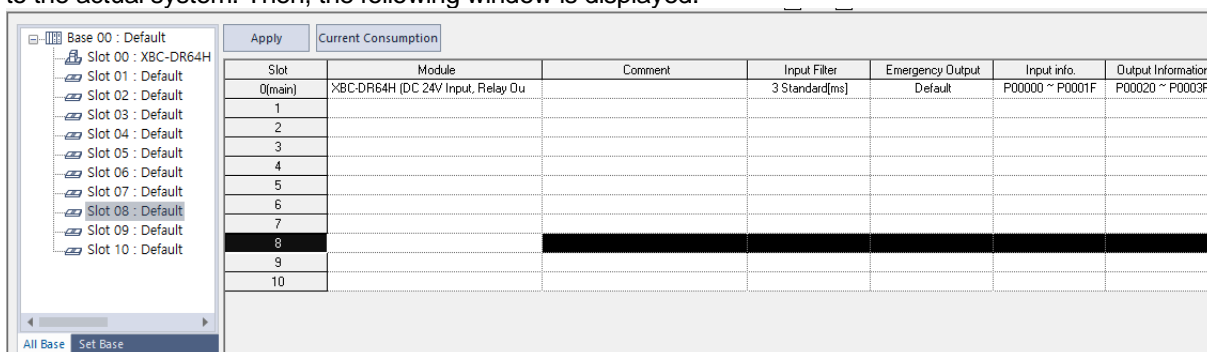

Clicking 『Details』 in 『Slot Position』 shows the following window to set filter and emergency output.

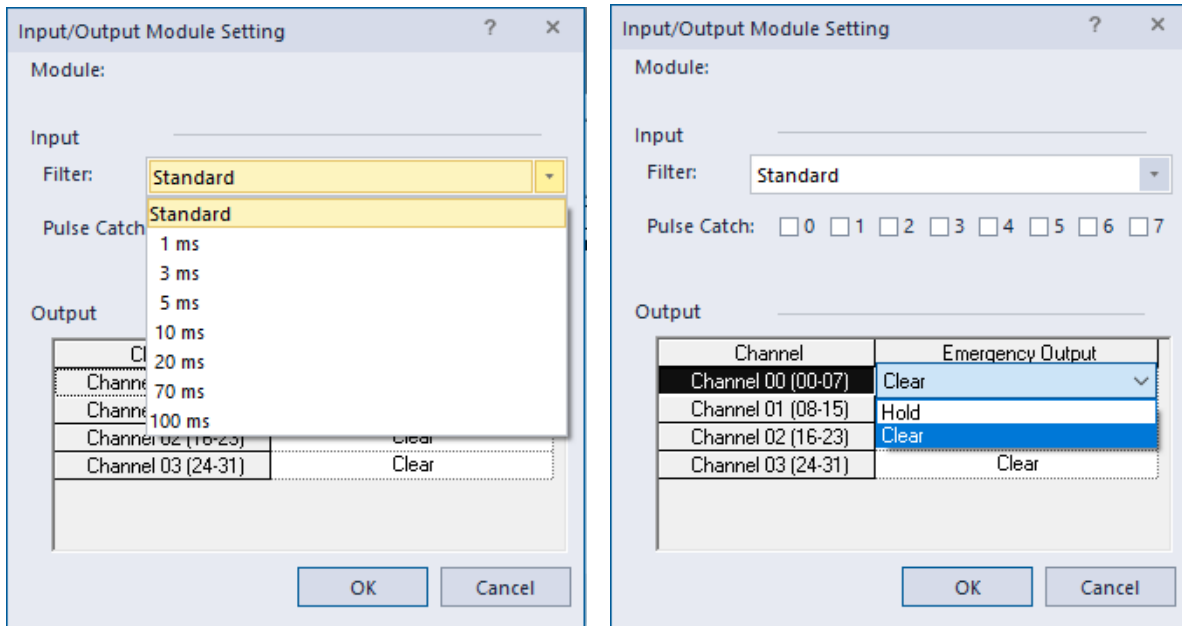

Remark

If settings are different with I/O module actually accessed, "Inconsistent module type error" occurs, displaying error.
Without settings, CPU reads each I/O module information and operates.

6.3 Self-diagnosis Function

6.3.1 Saving of error log

CPU module logs errors occurred so that the causes will be identified and fixed easily. Clicking 『Error/Warning』 of 『Online』 shows the current error and previous error log.

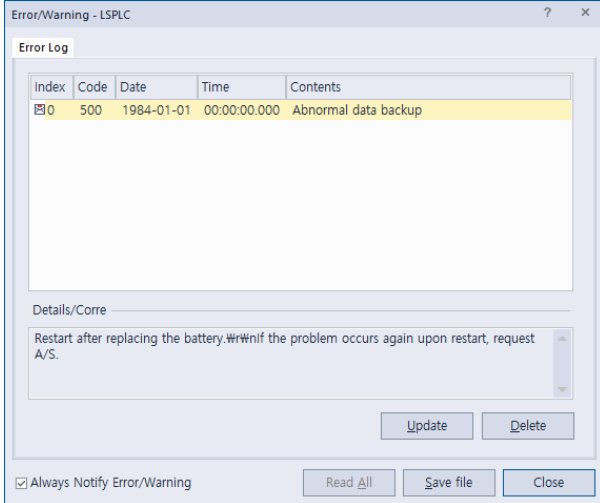

["S" type]

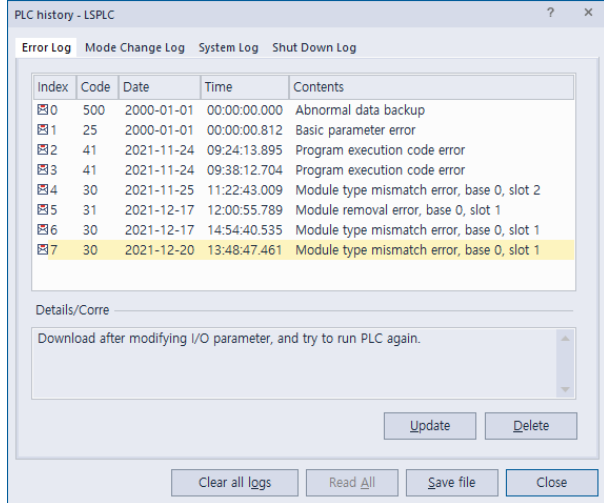

["H" type]

Item	Description	Remarks
Error/Warning	Display the current error/warning.	-
Error Log	Display a log of error/warning occurred.	Saving up to 100

Remark

- 1) Saved data are not deleted until selecting a menu of XG5000 and clicking "Delete".
- 2) "H" type displays Data and Time.

6.3.2 Troubleshooting

(1) Trouble types

Trouble occurs due to PLC itself, system configuration error or abnormal operation result detected. Trouble is divided into trouble mode stopping operation for the safety and warning mode generating alert to user with a mode in trouble.

The causes troubling PLC system are as follows.

- PLC hardware trouble
- System configuration error
- Operation error while operating user program
- Error detected owing to external device in trouble

(2) Operation mode if trouble occurs

PLC system logs any trouble occurred in flag and determines whether to stop or resume operation depending on trouble mode.

A) PLC hardware trouble

In case an error occurs so that PLC such as CPU module and power module may not work normally, the system is halted, but any warning may not interfere with the operation.

B) Operation error while operating user program

Representing an error occurred during operation of user program, in case of numeric operation error, it displays the error in error flag but the system resumes operating. However, if the operation time exceeds by the operation monitoring time limit and I/O module does not control it normally, the system is halted.

C) Error detected owing to external device in trouble

Representing the detection of external device to be controlled by users program of PLC, if an error is detected, the system is halted, but any warning may not interfere with the operation.

Remark

- 1) If any trouble occurs, the unique trouble number is saved in a special relay F****.
- 2) For details of flag, refer to the appendix 1 Flag List.

6.4 Remote Functions

CPU module may change operation by communication as well as by key switches mounted on the module. To operate it remotely, it is necessary to set 'RUN/STOP' switch to 'STOP'.

(1) Remote operations are as follows.

- Operable by accessing to XG5000 through RS-232C port mounted on CPU module.
- Can operate other PLC connected to PLC network with CPU module connected to XG5000.

(2) Remote RUN/STOP

- Remote RUN/STOP is the externally controlled RUN/STOP function.
- It is convenient when CPU module is located at a position hard to control or when CPU module within control panel is to control RUN/STOP function remotely.

(3) Remote DEBUG

- It manages debugging remotely when remote mode is STOP. Namely, DEBUG operation is to execute program operation depending on designated operation conditions.
- Remote DEBUG is a convenient function when confirming program operation status or data during system debugging.

(4) Remote Reset

- Remote reset is to reset CPU module remotely if an error occurs at a place hard to directly control CPU module.
- Like operation by switches, it supports 'Reset' and 'Overall Reset'.

Remark

- 1) For details regarding remote functions, refer to 'Online' of XG5000 Users Manual.





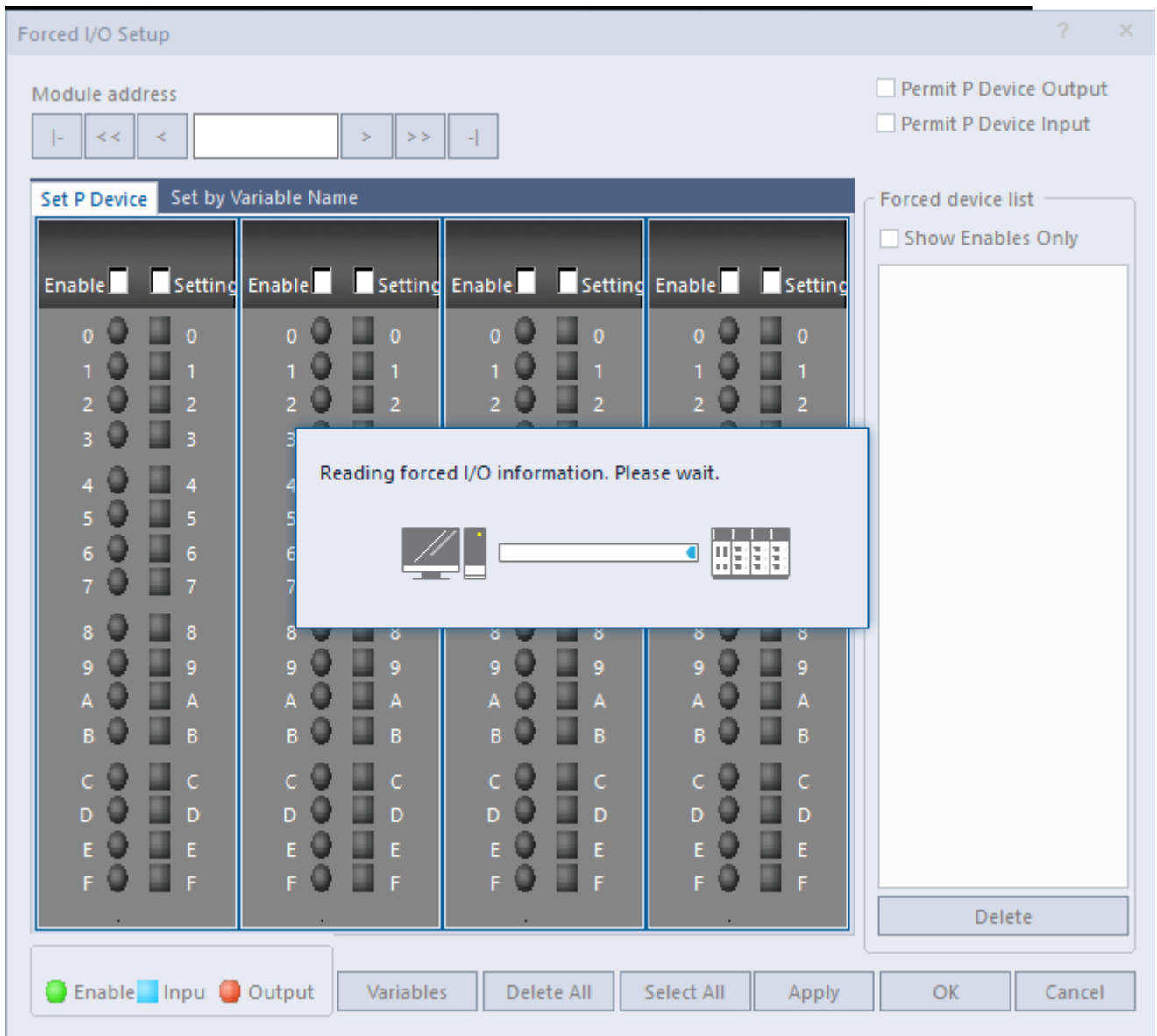

6.5 Forced Input/Output On and Off Function

Force I/O function is used to force to turn I/O areas on or off, regardless of program results.

6.5.1 Force I/O setup

Click 『 Online 』 - 『 Force I/O 』 .



Item		Description
Move address	 	Move to the beginning and end of I/O area (P000↔P127)
	 	Move to ±8 of I/O area displayed at the very left.
	 	Move to ±1 of I/O area.
Application		Set whether to allow or not Force I/O
Single	Flag	Set whether to allow or not Force I/O by bits.
	Data	Set Force I/O data on or off by bits.
Select All		Set to allow Force I/O with all I/O area on
Delete All		Delete to allow Force I/O with all I/O area off.
Setting device		Display I/O area set as a bit.

6.5.2 Processing time and processing method of Force Input/Output On and Off

(1) Forced Input

Regarding input, at the time of input refresh it replaces the data of contact set as Force On/Off among data read from input module with the data as Force and updates input image area. Therefore, user program executes operations with actual input data while Force input area is operated with data set as Force.

(2) Forced Output

Regarding output, at the time of output refresh upon the execution user program operation, it replaces the data of contact set as Force On/Off among data of output image area containing operation results with data set as Force and outputs the data in output module. Unlike (Force) input, the output image area is not changed by Force On/Off setting.

(3) Cautions when using Force I/O function

- It operates from the time when I/O is individually set as 'Allow' after setting Force data.
- It is possible to set Force input although I/O module is not actually mounted.
- Despite of the power changed Off -> On, operation mode changes or any operation by pressing reset key, the data of which On/Off is set before is kept in CPU module.
- Even in STOP mode, Force I/O data is not removed.
- To set new data from the beginning, it is necessary to deselect all settings of I/O by using 'Delete All' option.

6.6 Direct Input/Output Operation

Refreshing I/O operates after completion of scan program. If data of I/O is changed while program is scanned, it does not refreshed at the changed moment. Refreshed I/O data is applied after 'END' instruction on program.

This function may be useful when directly reading the status of input contact during program operation by refreshing I/O by means of 'IORF' instruction or outputting operation results to output contact.

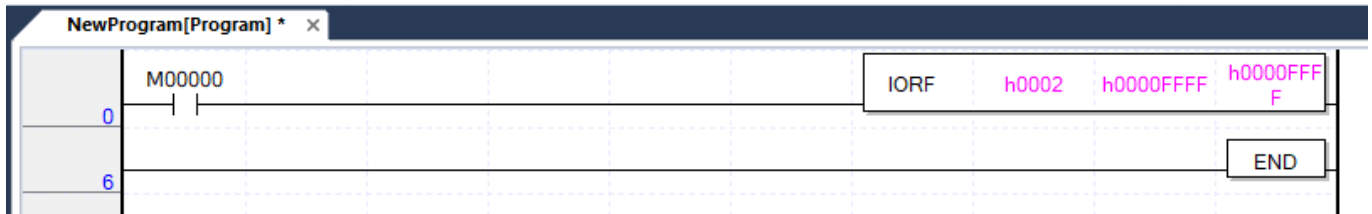

'IORF' command is operated when M00000 is ON. First operand designates slot number. Second operand designates the upper 32 bit data as mask data. Third operand designates the lower 32 bit data as mask data. The bit to refresh set as 1 (hFF) and others set as 0 (h00) (not refreshed).

Remark

For details regarding IORF instruction, refer to XGB Instructions List.

6.7 Diagnosis of External Device

This flag is provided for a user to diagnose any fault of external device and, in turn, execute halt or warning of the system. Use of this flag displays faults of external device without any complicated program prepared and monitors fault location without any specific device (XG5000 and etc) or source program.

(1) Detection and classification of faults in external device

- The trouble (fault) of external device may be detected by user program and largely divided, depending on the type, into error and warning; the former requires halt of PLC operation and the latter simply displays the status while PLC keeps working.
- 'Error' uses 'F202 (_ANC_ERR)' and 'Warning' uses 'F203 (_ANC_WB) flag'.
- As the detection request flag, 'Error' uses 'F2002 (_CHK_ANC_ERR) flag' while 'Warning' uses 'F2003 (_CHK_ANC_WB) flag'.

(2) Troubleshooting external device

- When detecting any trouble of external device in user program, it writes a value except '0' by classifying the type, which is defined by a user in 'F202 (_ANC_ERR)' while the detection request flag checks it at the time when the program ends with 'F2002 (_CHK_ANC_ERR) On, and PLC turns off all output, making it as the same error status as detected by PLC itself.
- If any trouble occurs, a user may identify the cause by using XG5000 and alternatively by monitoring 'F202 (_ANC_ERR) flag'.

□ Example

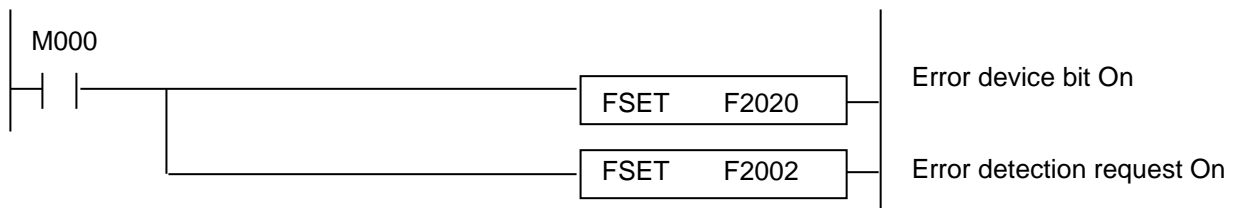

- If any trouble occurs, CPU is in error status and operation halts. At this moment, F2020 and F2002 flags are off (error LED switches on and off every second.)

(3) Processing warning of external device

- When detecting any warning of external device in user program, it turns on a flag in the warning position of system flag 'F203 (_ANC_WB) and if turning on the detection request flag, 'F2003 (_CHK_ANC_WB)' , it displays warning at the time when scan program ends. If a warning occurs, the detection request flag, 'F2003 (_CHK_ANC_WB)' is automatically off (F203 is not deleted).
- If a warning occurs, the LED switches on and off every other second.
- If turning off a bit in question of F203 and turning on F2003 bit after processing warning, warning is cancelled and the LED turns off.

□ Example

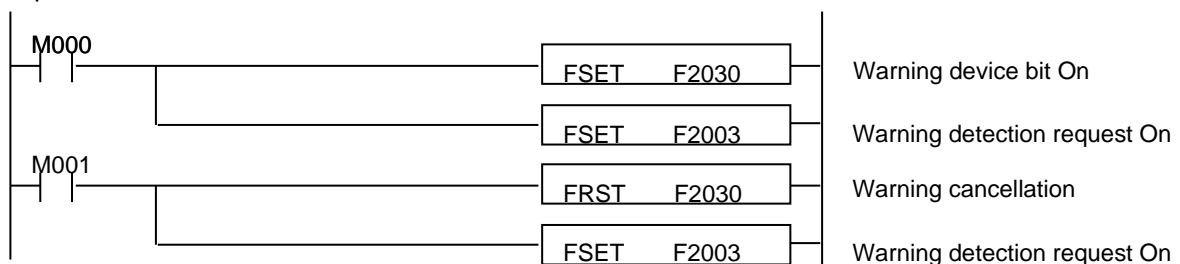

6.8 Allocation of Input/Output Number

Allocation of I/O number is to allocate an address to every I/O of each module to read data from input module and output data to output module when it executes operations. XGB series adopts 64 points occupation to every module.

(1) Allocation of I/O number

64 points are allocated to every module (incl. special, communication).

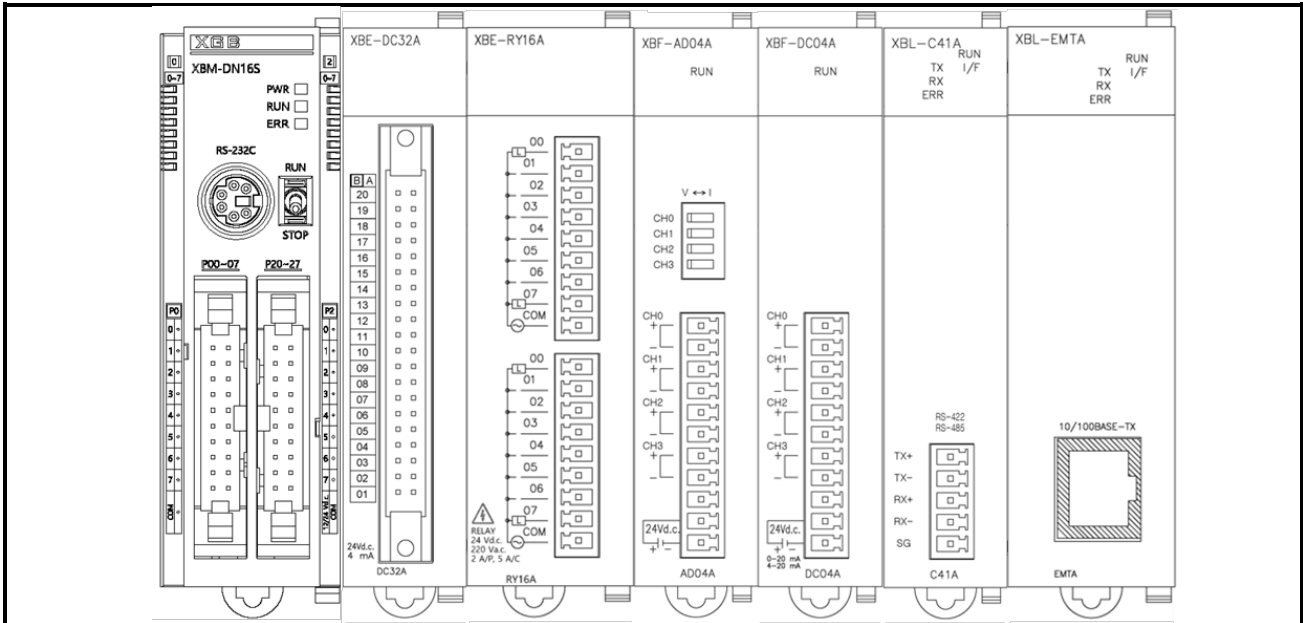

Number of Connection stage	Type	I/O allocation	Remarks
0	XBM-DN32S	Input: P0000 ~ P001F Output: P0020 ~ P003F	Basic unit fixed
1	XBE-DC32A	Input: P0040~P007F	Actual input: P0040 ~ P004F
2	XBE-RY16A	Output: P0080~P011F	Actual Output: P0080 ~ P009F
3	XBE-AD04A	Input: P0120~P015F	Actual input: P0120 ~ P013F
4	XBF-DC04A	P0160 ~ P019F	-
5	XBL-C41A	P0200 ~ P027F	-
6	XBL-EMTA	P0240 ~ P027F	-

Empty I/O point is available for internal relay.

(2) In case of allocating IO of IO parameter, allocation information is displayed.

Base 00 : Default
 Slot 00 : XBC-DR64H
 Slot 01 : XBE-DC08A
 Slot 02 : Default
 Slot 03 : Default
 Slot 04 : Default
 Slot 05 : Default
 Slot 06 : Default
 Slot 07 : Default
 Slot 08 : Default
 Slot 09 : Default
 Slot 10 : Default

Apply Current Consumption

Slot	Module	Comment	Input Filter	Emergency Output	Input info.	Output Information
0(main)	XBC-DR64H (DC 24V Input, Relay Ou		3 Standard[ms]	Default	P00000 ~ P0001F	P00020 ~ P0003F
1	XBE-DC08A (DC 24V Input, 8 Contact		3 Standard[ms]		P00040 ~ P00047	
2						
3						
4						
5						
6						
7						
8						
9						
10						

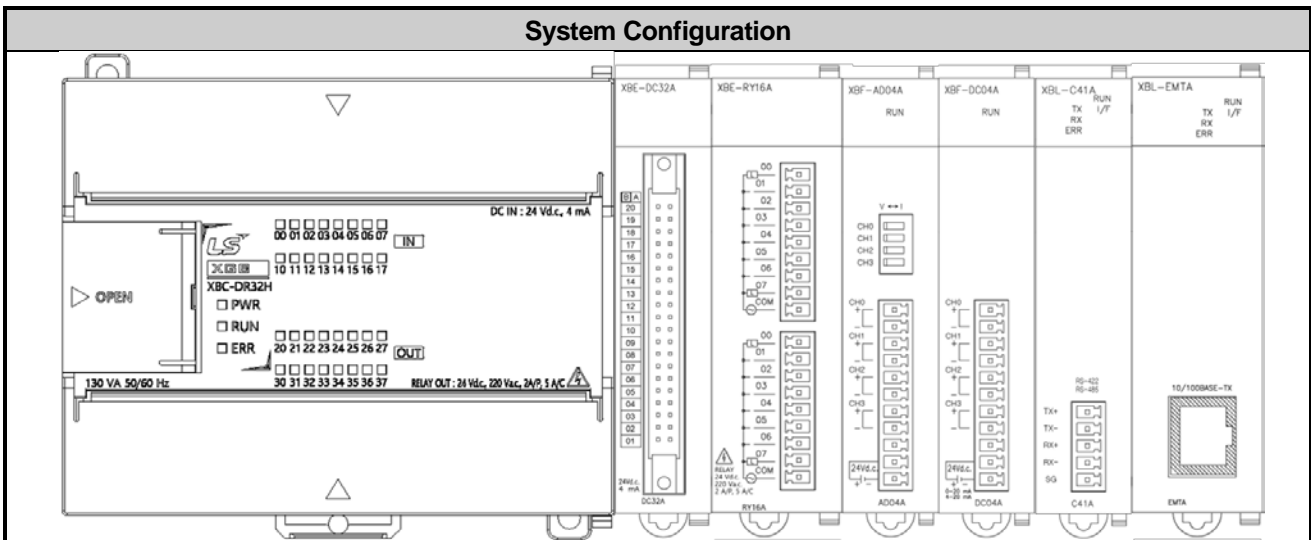

Number of Connection stage	Type	I/O allocation	Remarks
0	XBC-DN32H	Input: P0000 ~ P001F Output: P0020 ~ P003F	Basic unit fixed
1	XBE-DC32A	Input: P0040~P007F	Actual input: P0040 ~ P004F
2	XBE-RY16A	Output: P0080~P011F	Actual Output: P0080 ~ P009F
3	XBE-AD04A	Input: P0120~P015F	Actual input: P0120 ~ P013F
4	XBF-DC04A	P0160 ~ P019F	-
5	XBL-C41A	P0200 ~ P027F	-
6	XBL-EMTA	P0240 ~ P027F	-

In case of using monitor function of XG5000, I/O allocation information is displayed.

I/O module allocation information

Description of each module

System Information	Address Assignment - Fixed	Comment
<ul style="list-style-type: none"> Base 0 : XGB-JM11D CPU : XBC-DxxxH Slot 0: Internal Cnet Slot 1: XBC-DR64H Slot 2: XBE-DC16A/B Slot 3: XBE-TN/TP16A Slot 4: XBE-TN/TP16A Slot 5: XBF-DV04C Slot 6: XBL-C41A Slot 7: Empty slot Slot 8: Empty slot Slot 9: Empty slot Slot 10: Empty slot 	<p>[P00000 ~ P0003F]</p> <p>[P00040 ~ P0007F]</p> <p>[P00080 ~ P0011F]</p> <p>[P00120 ~ P0015F]</p> <p>[P00160 ~ P0019F]</p> <p>[P00200 ~ P0023F]</p> <p>[P00240 ~ P0027F]</p> <p>[P00280 ~ P0031F]</p> <p>[P00320 ~ P0035F]</p> <p>[P00360 ~ P0039F]</p> <p>[P00400 ~ P0043F]</p>	<p>Base (11 Slots -1 Slot for Internal, 10 Slots for External)</p> <p>High Performance CPU Module(I/O: Maximum 384 Points)</p> <p>Internal Cnet Module(RS-232C, RS-485)</p> <p>DC 24V Input, Relay Output, 64 Contacts</p> <p>DC 24V Input, 16 Contacts / DC12/24V Input, 16 Contacts</p> <p>D/A Current Output Type(4 Channels)</p> <p>Transistor Output, 16 Contacts (0.2A, Sink Output/Source Output)</p> <p>Transistor Output, 16 Contacts (0.2A, Sink Output/Source Output)</p> <p>D/A Voltage Output Type, 4 Channels, 14bit</p> <p>Cnet Module(RS-422/485)</p>

6.9 Online Editing

It is possible to modify program and communication parameter during operation of PLC without control operation stopped. The following describes basic modification. For details of modifying program, refer to XG5000 Users Manual.

Items to be modified during operation are as follows.

- Program
- Communication parameter

(1) It displays programs that are currently running.

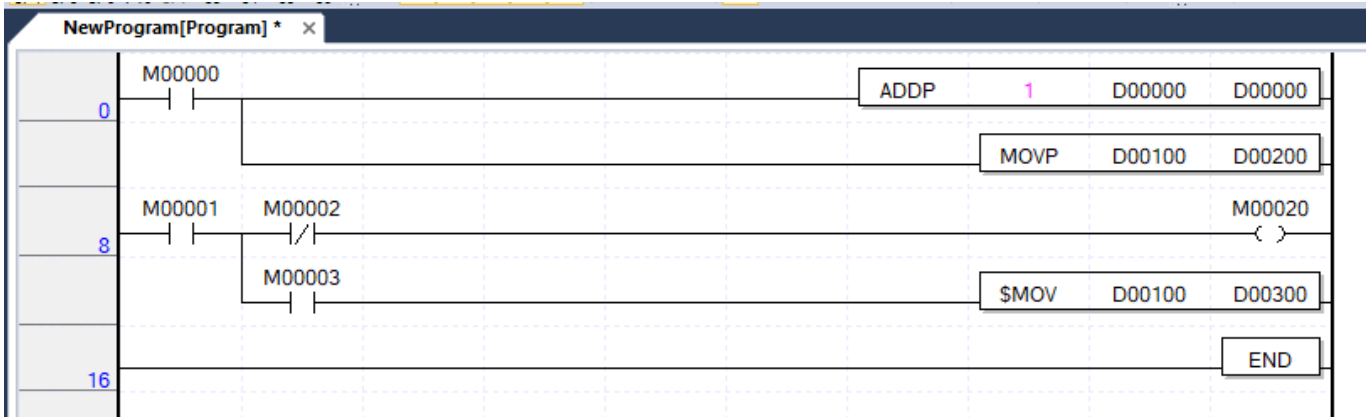

(2) Click 『Online』 - 『Start Online Editing』 .

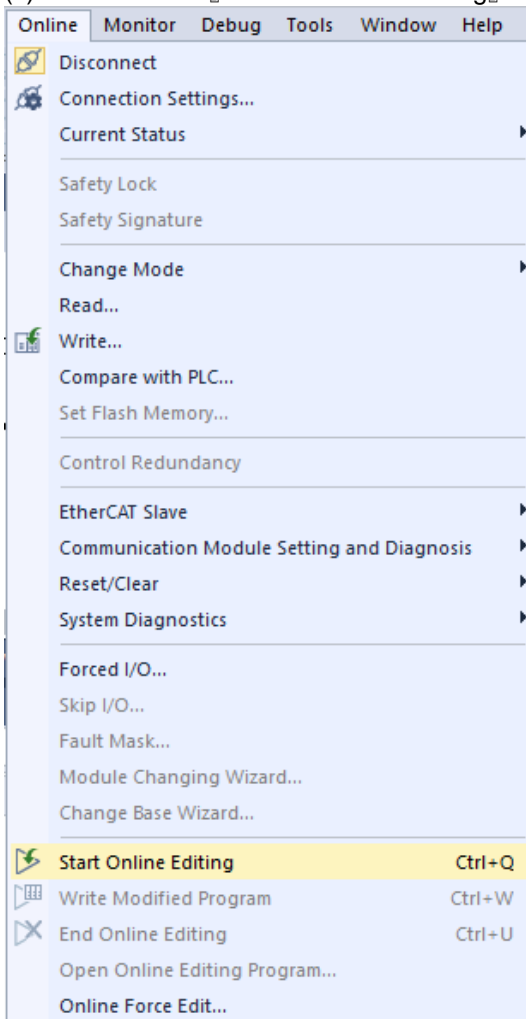

Chapter 6. CPU Functions

(3) It turns to program modification mode during run when the program background is changed.

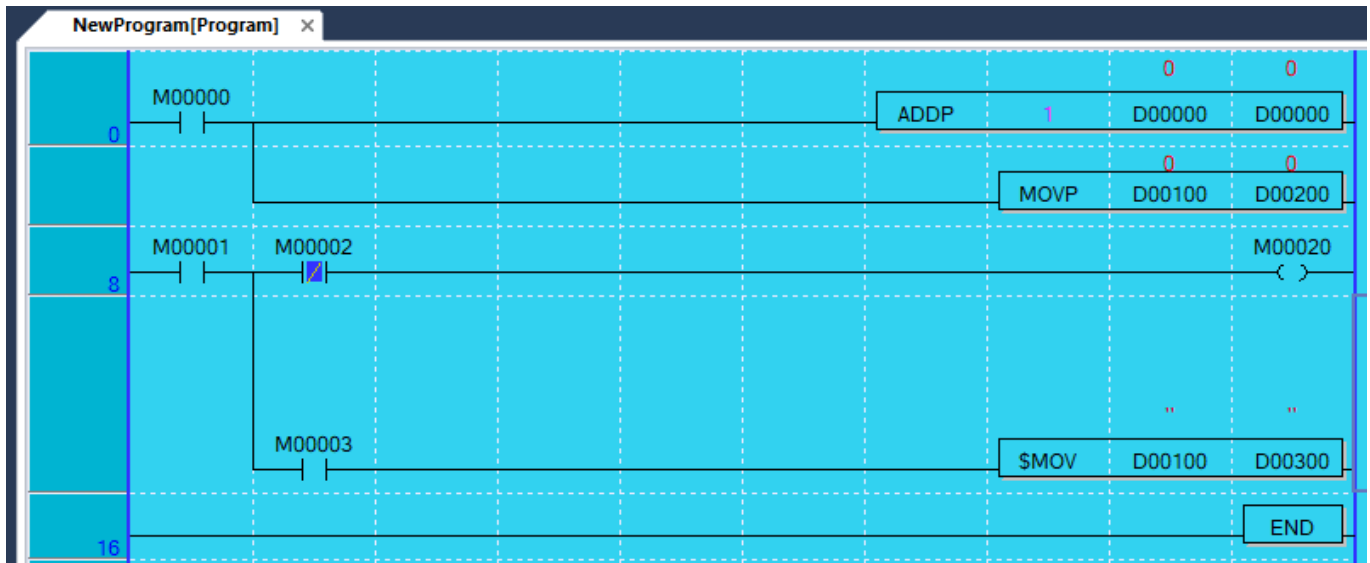

(4) Modifying a program.

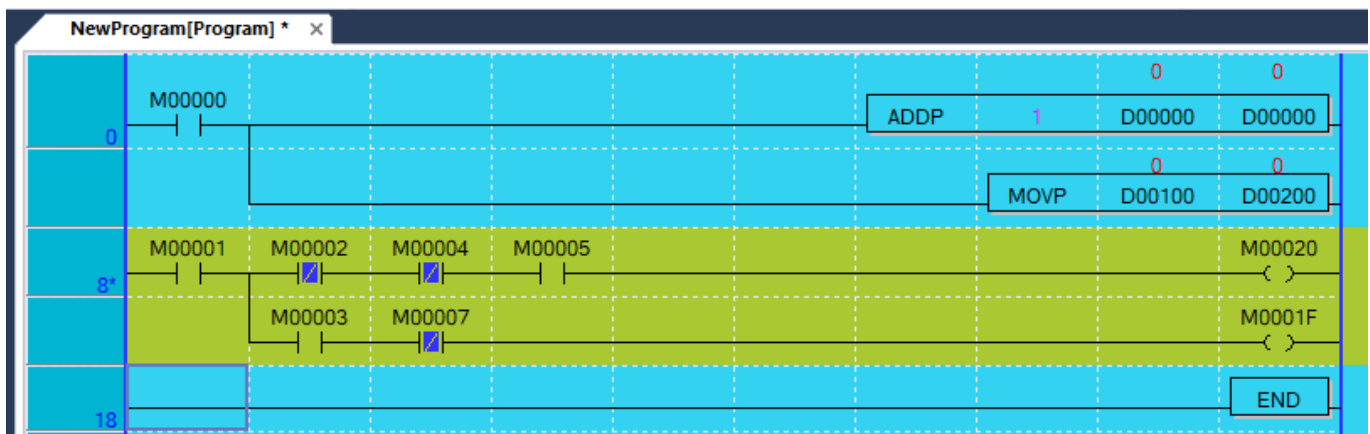

(5) Upon the modification of program, click 『Online』 - 『Write Modified Program』 .

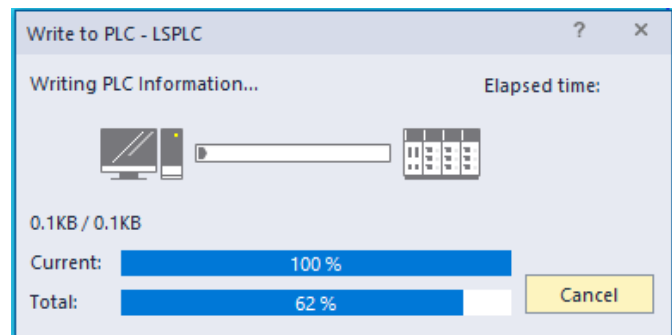
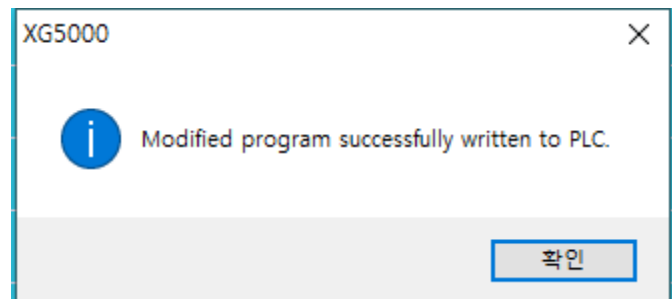
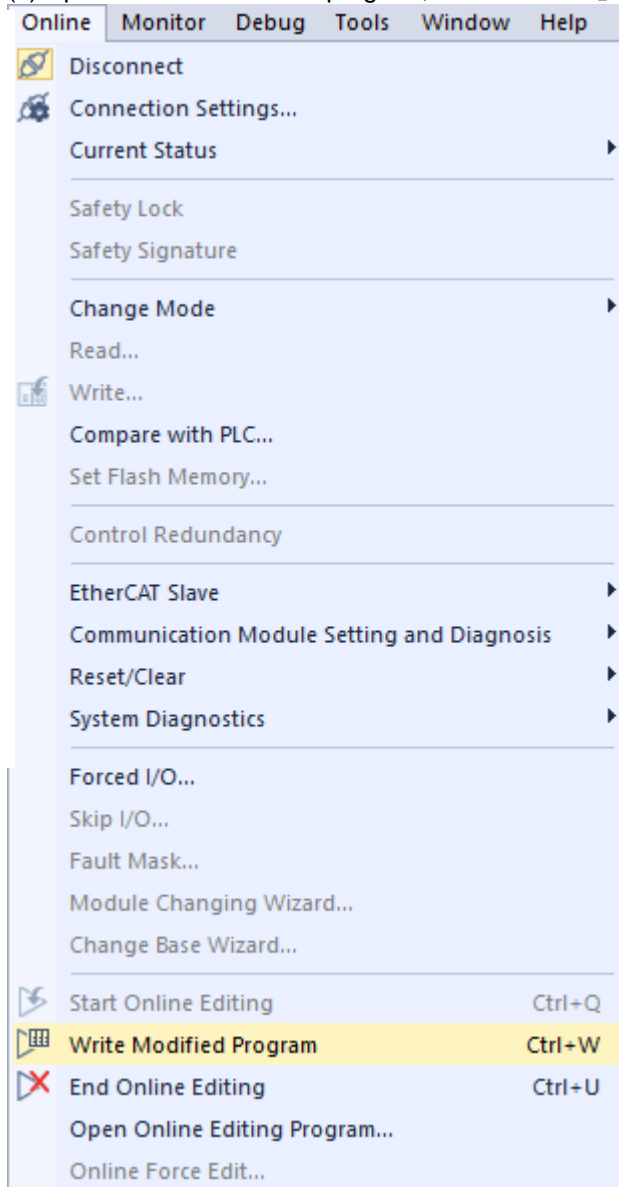

Chapter 6. CPU Functions

(6) Upon the writing of program, click 『Online』 - 『End Online Editing』 .

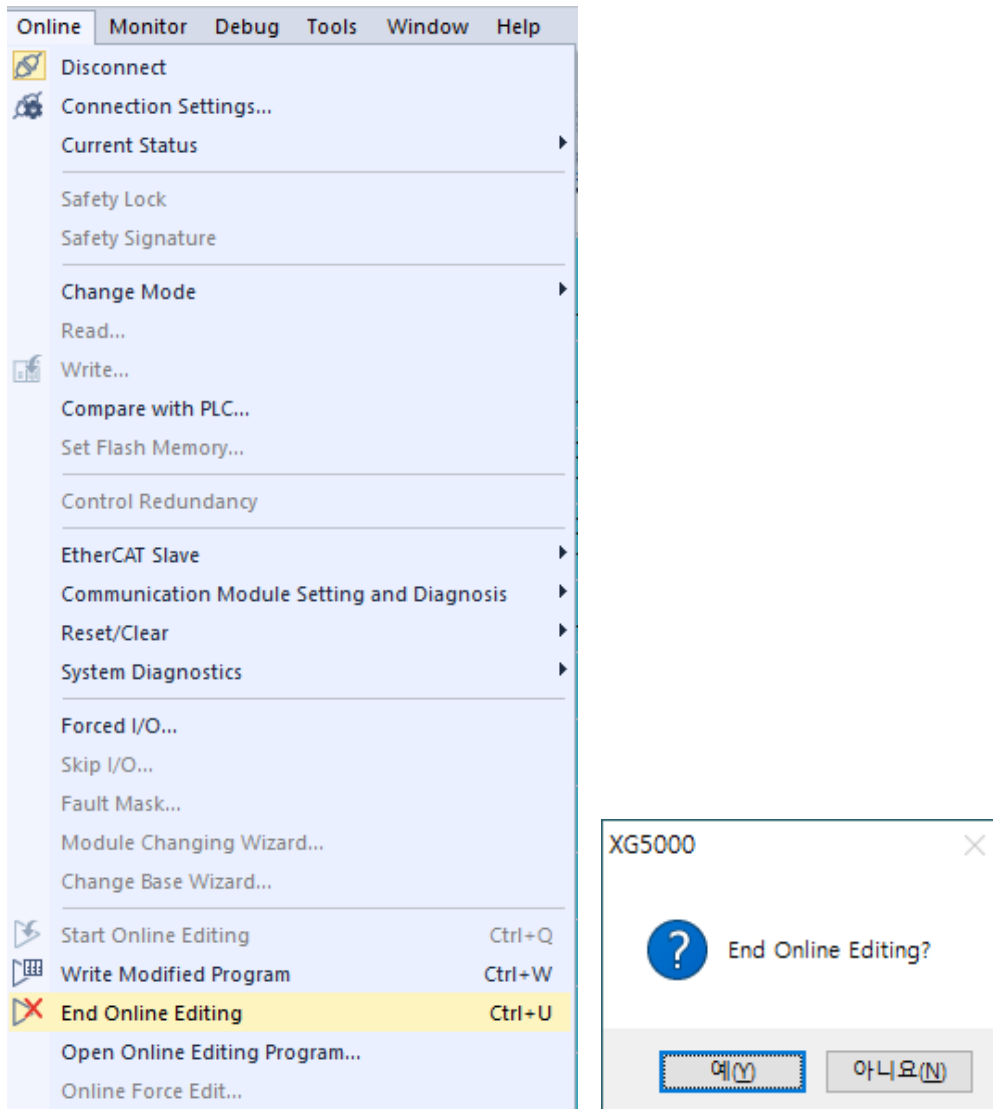

(7) The program background returns and the program modification during run is completed.

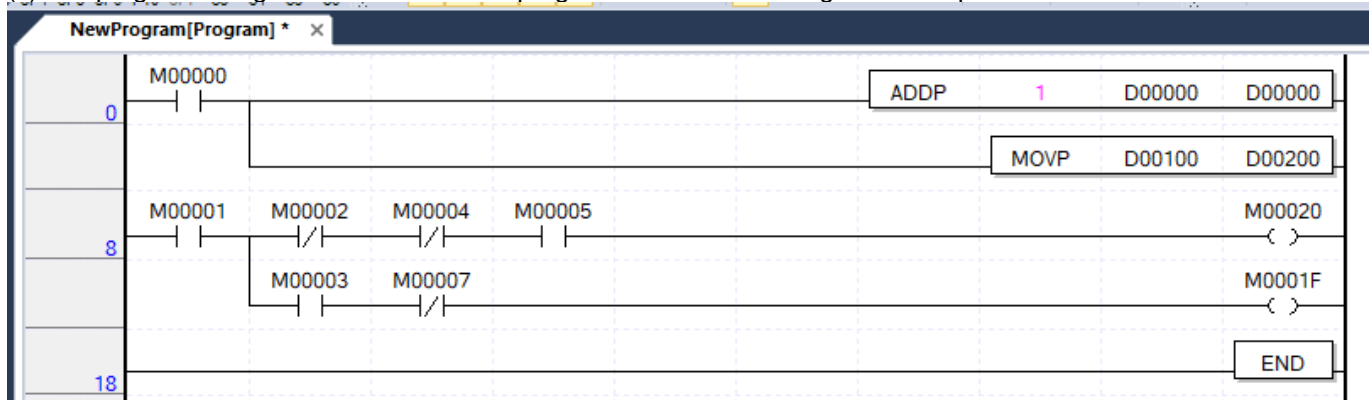

Remark

- For parameter modification during run, change each parameter on XG-PD and click 『Online』 - 『Write Modified Program』 .

6.10 Reading Input/Output Information

It monitors information of individual modules consisted of XGB series system.

- (1) Click 『Online』 - 『I/O Info』 . Then, information of each module connected to the system is monitored.

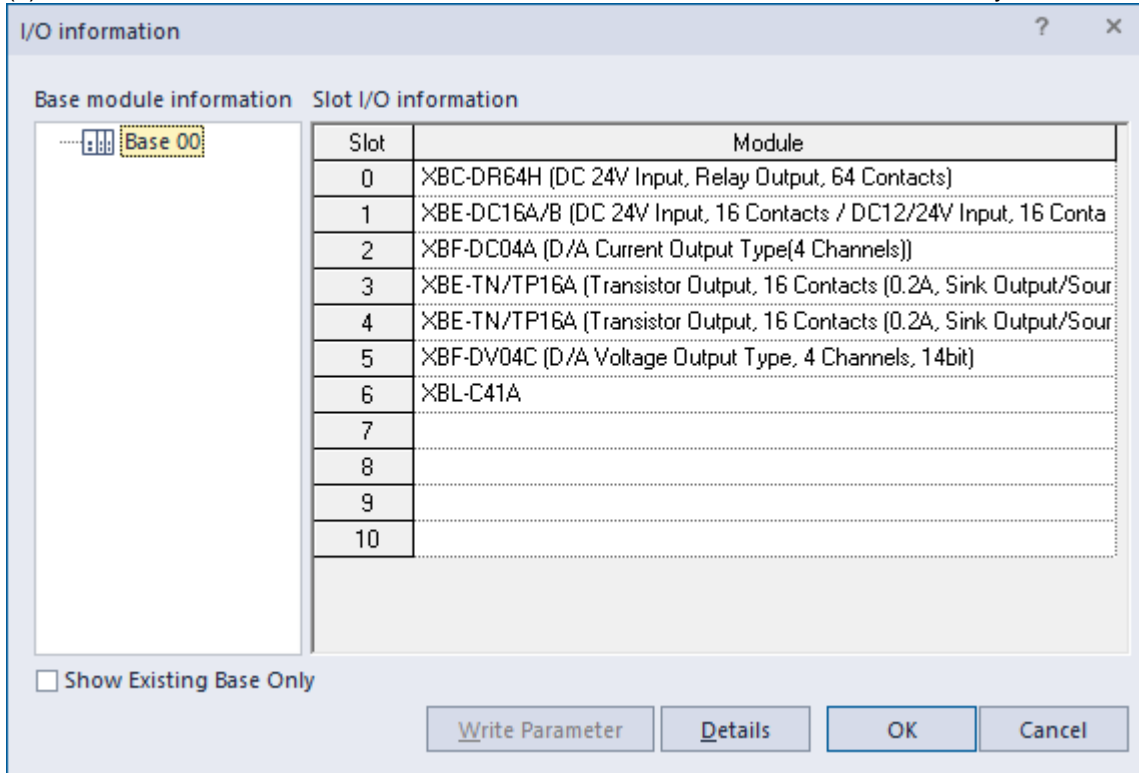

- (2) It clicking Details after selecting a module, it displays detail information of a selected module.

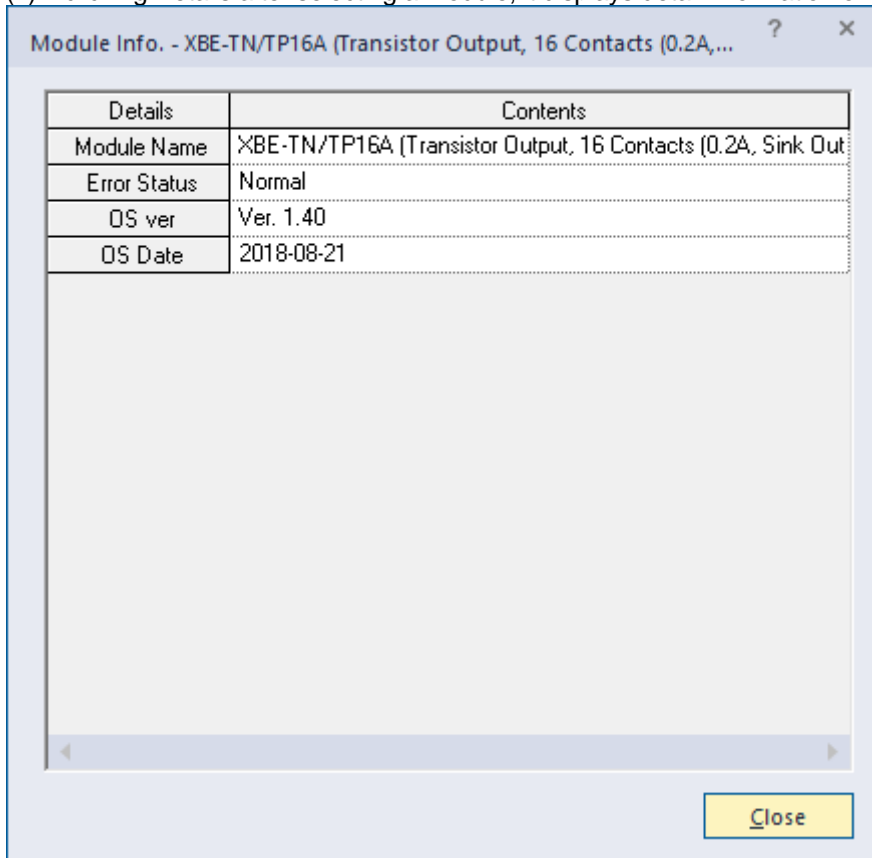

6.11 Monitoring

It monitors system information of XGB series system.

(1) Clicking 『Monitor』 displays the following sub-menus.

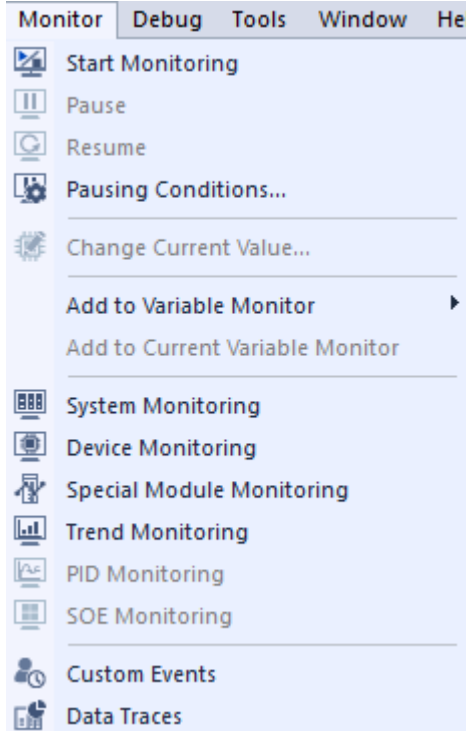

(2) Items and descriptions

Item	Description	Remarks
Start/Stop Monitoring	Designate the start and stop of monitor.	Click for reverse turn.
Pause	Pause monitoring.	-
Resume	Resume paused monitor.	-
Pausing Conditions	Pause monitoring if a preset value of device corresponds to condition.	Monitor resumes; clicking for resume.
Change Current Value	Change the present value of currently selected device.	-
System Monitoring	Monitor general system information.	-
Device Monitoring	Monitor by device (type).	-
Trend Monitoring	Monitor trend of device set in the system.	For details, refer to XG5000 Users Manual.
Custom Events	Monitor the value of device set when an event set by a user occurs.	
Data Traces	Trace the value of device.	

(a) Change current value

- It changes the current value of each device selected in the current program window.

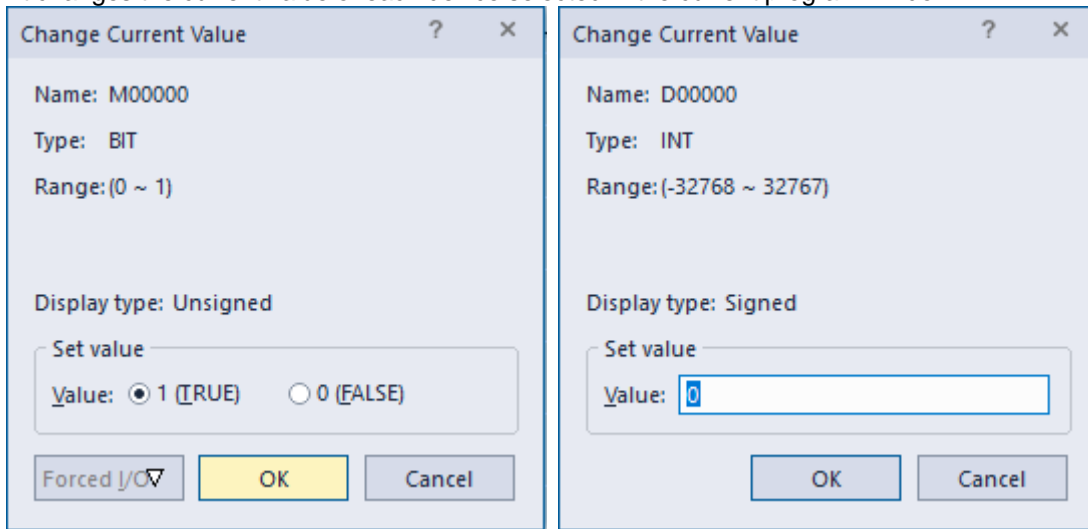

(b) Device monitoring

- It monitors by device (type).

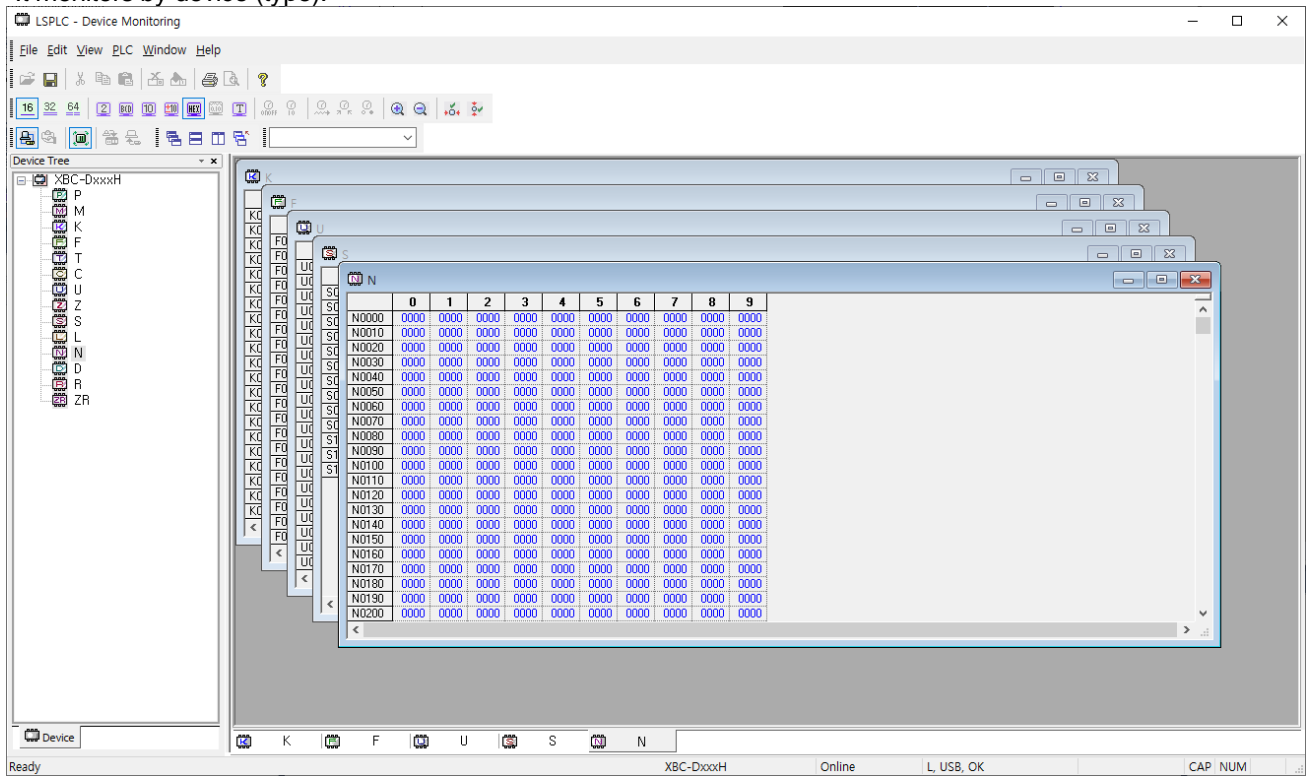

Chapter 6. CPU Functions

(c) Pausing conditions

- It stops monitoring in case a device value set in the program corresponds.

The 'Pausing Conditions - LSPLC' dialog box contains a table with the following data:

	Use	Type	Device	Condition	Set Value	Variable	Comment
1	<input checked="" type="checkbox"/>	INT	D00000	==	20		
2	<input type="checkbox"/>						
3	<input type="checkbox"/>						
4	<input type="checkbox"/>						
5	<input type="checkbox"/>						
6	<input type="checkbox"/>						
7	<input type="checkbox"/>						
8	<input type="checkbox"/>						
9	<input type="checkbox"/>						
10	<input type="checkbox"/>						

The 'Monitor Pause' dialog box displays the following information:

- Monitor is paused.
- Name: D00000
- Condition: ==
- Set Value: 20
- Value: 20

(d) Trend monitoring

- It displays device values graphically.

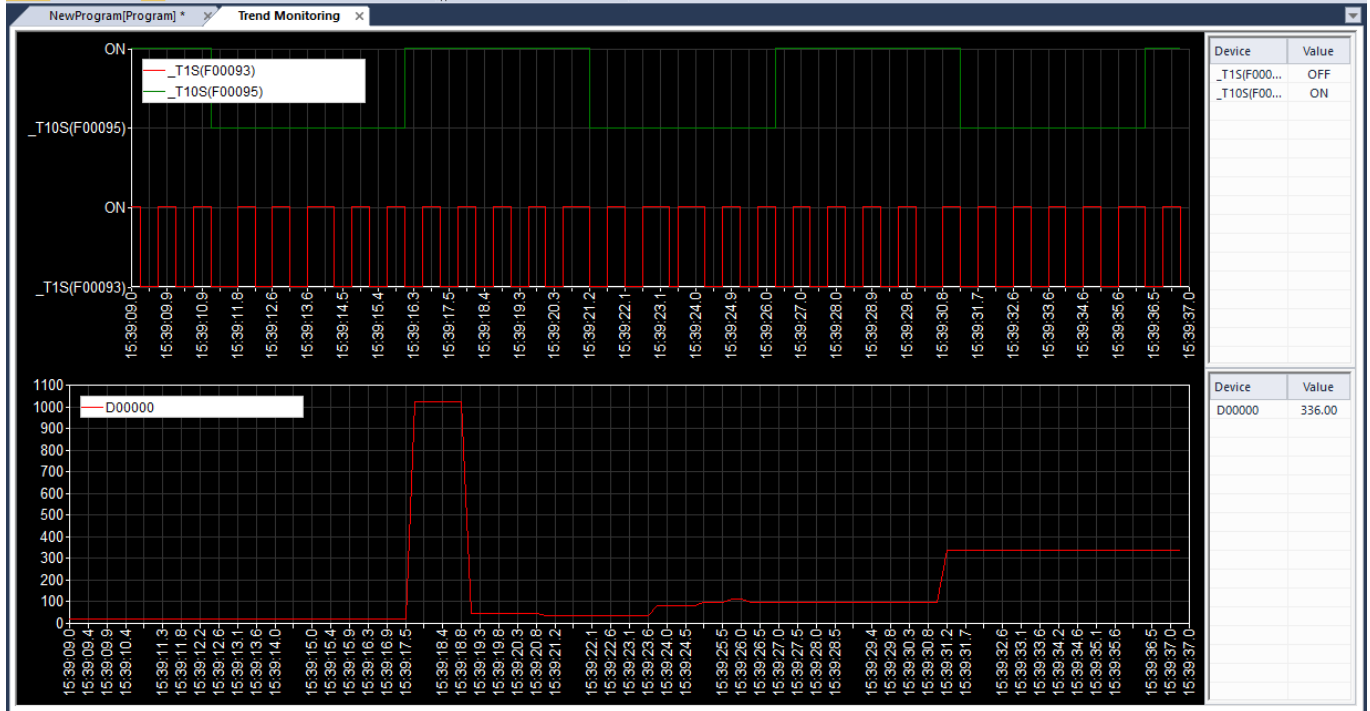

(e) Custom events

- It monitors detail information when an event set by a user occurs. Additional user event may be registered.

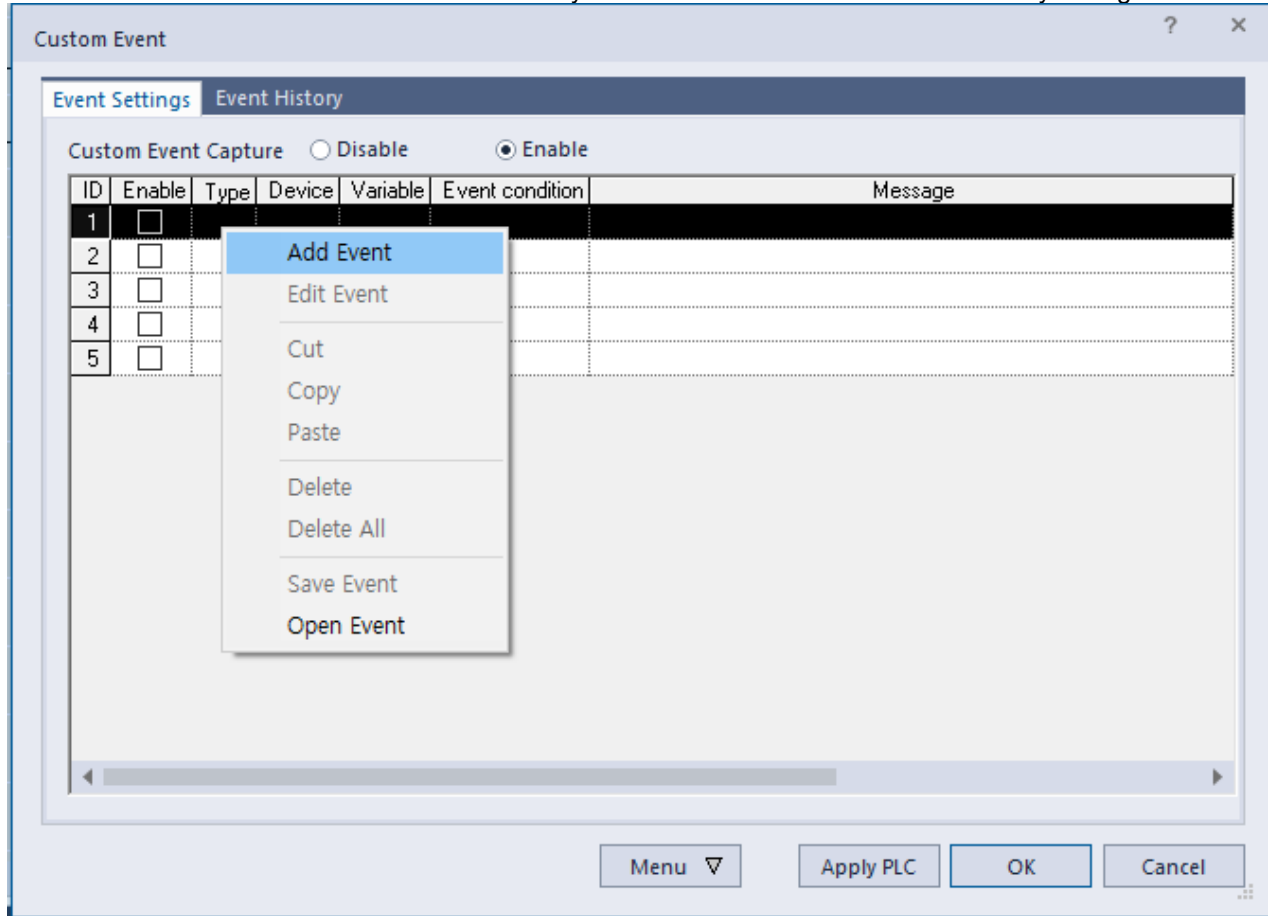

- It sets basic setting and relative device.

If rising edge of M0000 device occurs, it records the message of an alarm, "Out of order Water Tank 1" and the device values of D0000,L0000,D0100,N1000 are recorded.

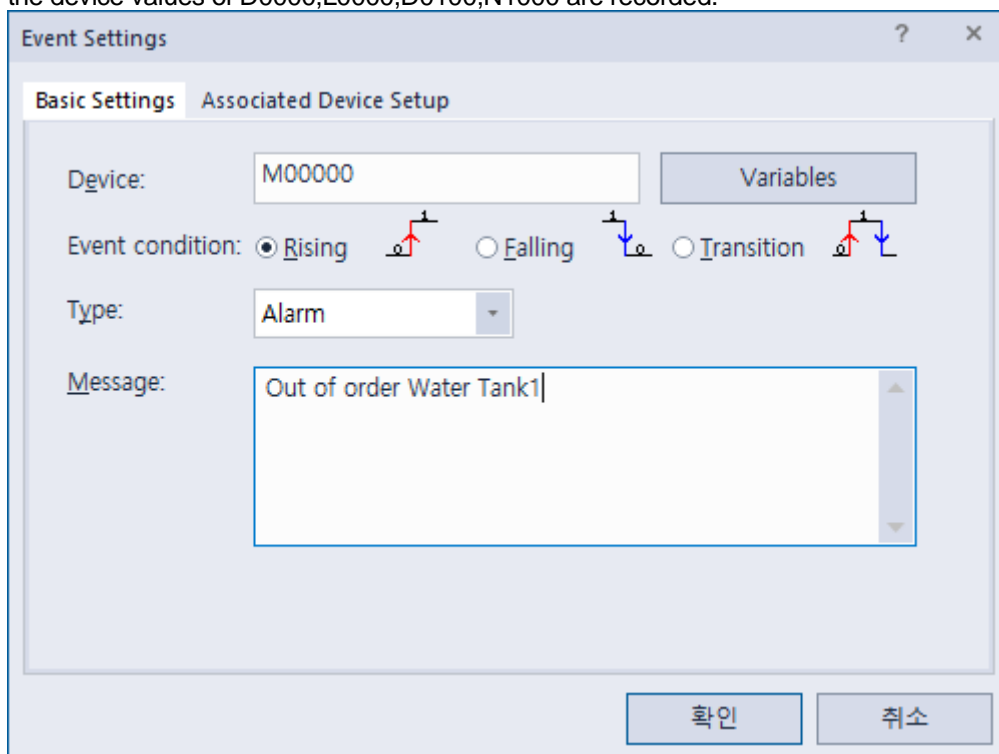

- Set the relative device(s).

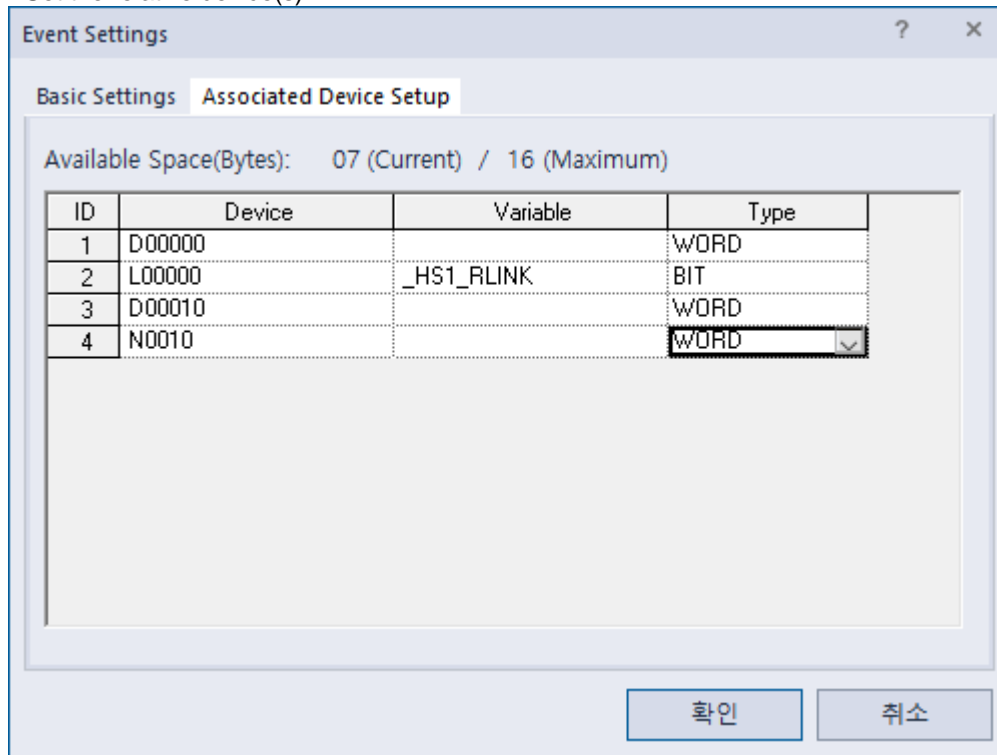

- Monitor event history of custom event.

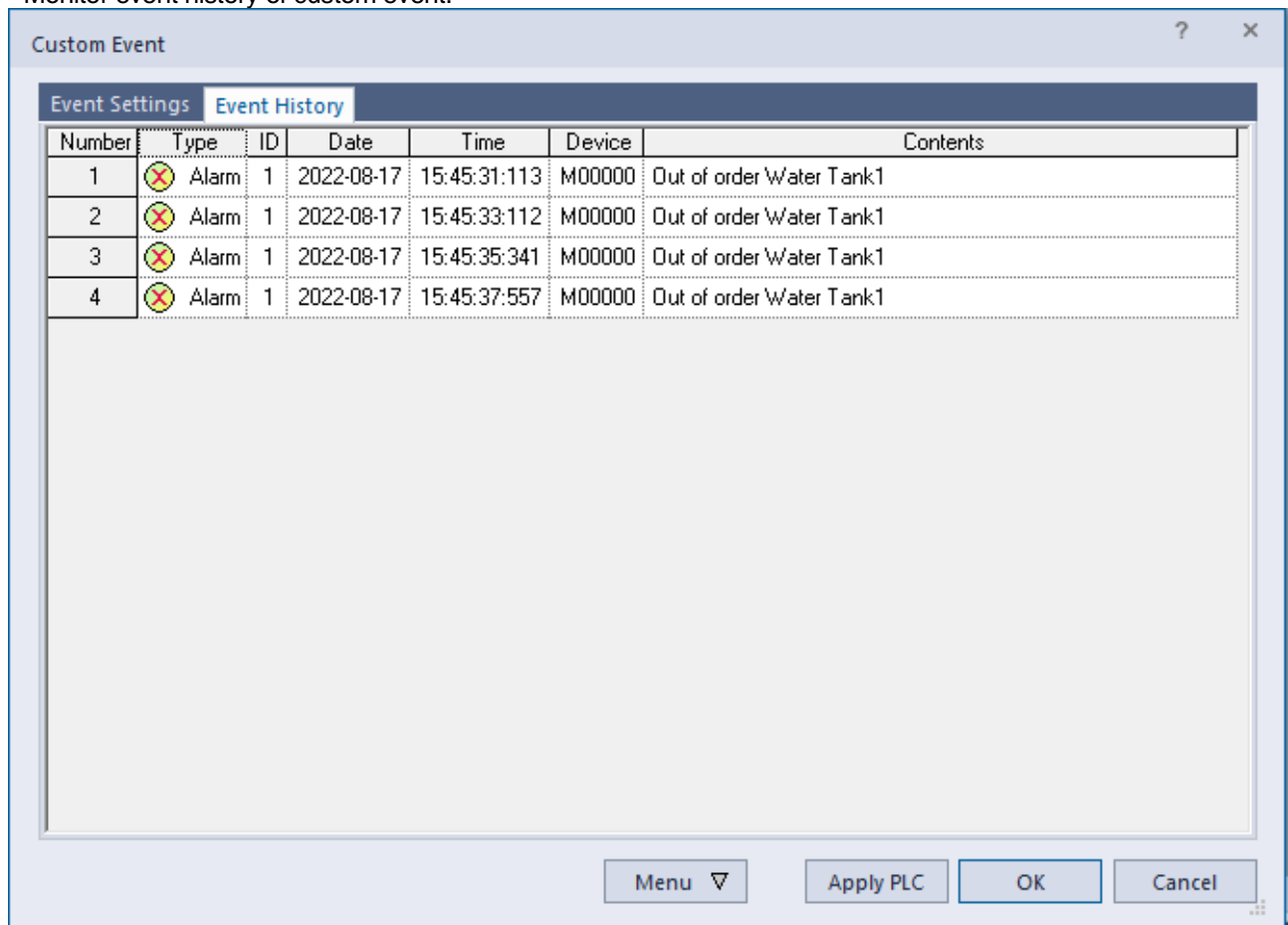

- Double-clicking a number produced monitors the relative values of device and the detail message as follows.

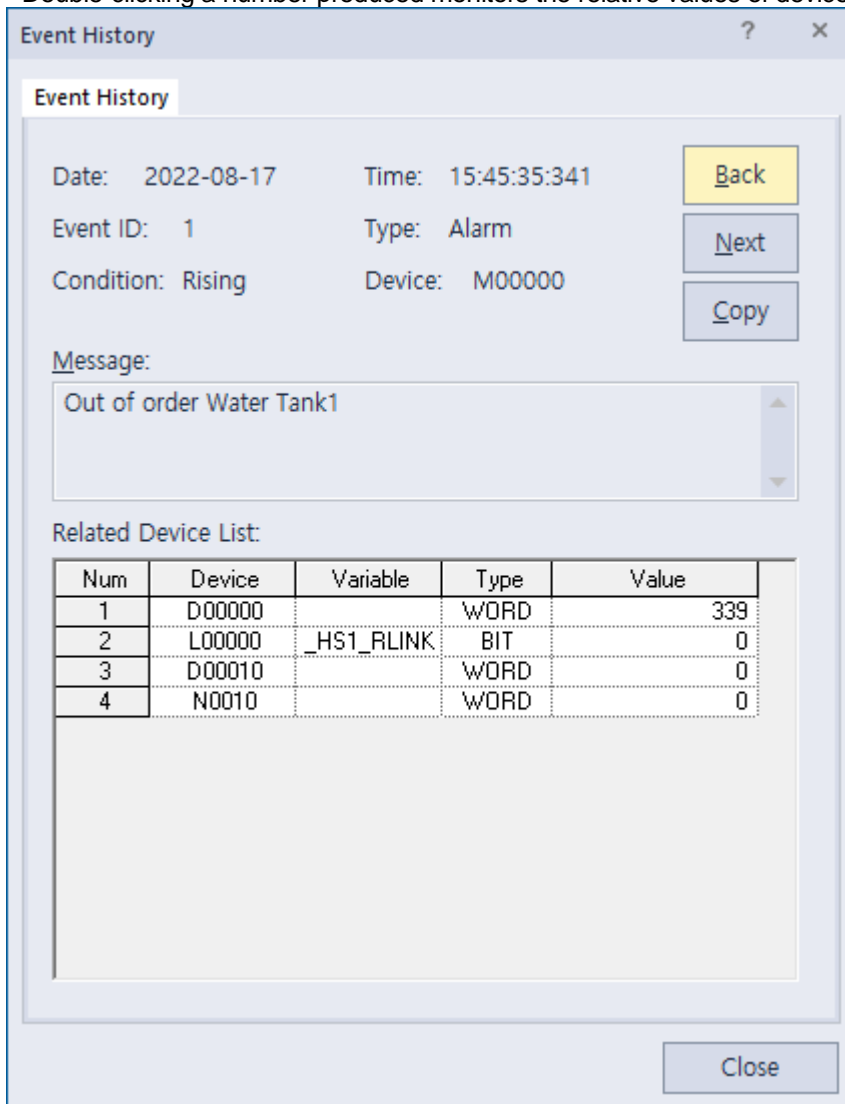
**Remark**

•For details of monitor, refer to XG5000 Users Manual.

6.12 RTC function

“H” type (XBC-DxxxH) supports the RTC (clock) function and user can use this function for time management of system or error log. RTC function is executed steadily when power is off or instantaneous power cut status. Current time of RTC is renewed every scan by system operation status information flag.

6.12.1 How to use

- (1) Reading/setting clock data
 - (a) Reading or setting from XG5000
 - 1) Click 『Online』 의 『PLC Information』 .
 - 2) Click PLC RTC tap of PLC Information』 .

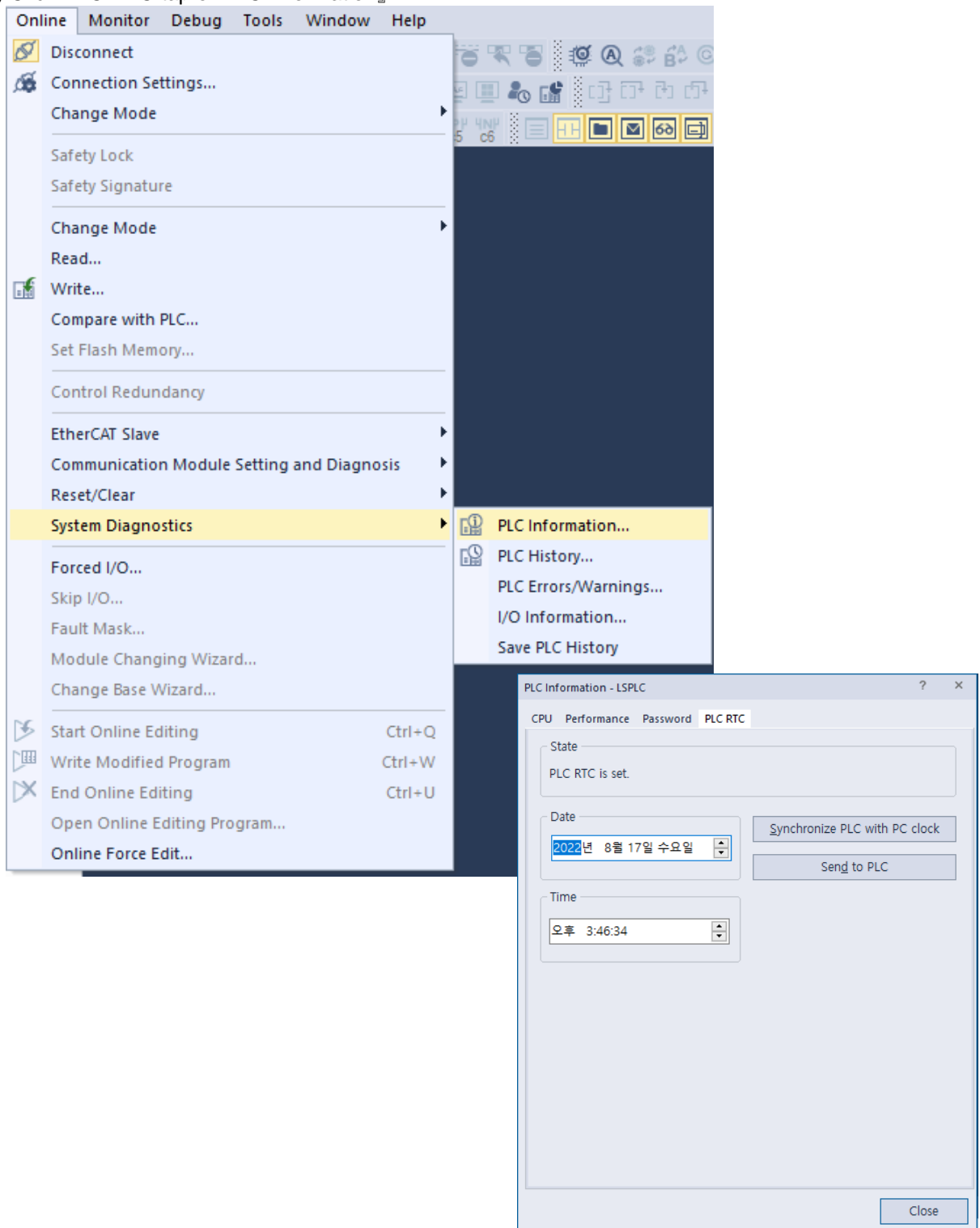

- 3) In case the user wants to send the clock of PC to PLC, press 'Synchronize PLC with PC clock'.
- 4) In case the user wants to send the clock the user wants, change the setting value of Time box and press 'Send to PLC'.

(b) Reading by special relay

The user can monitor as follows by special relay.

Special relay area	Data	Contents
F053	H0709	07year 9month
F054	H1214	12date 14hour
F055	H2040	20minute 40second
F056	H2003	20XXyear, Wednesday

(c) Modification of clock data by program

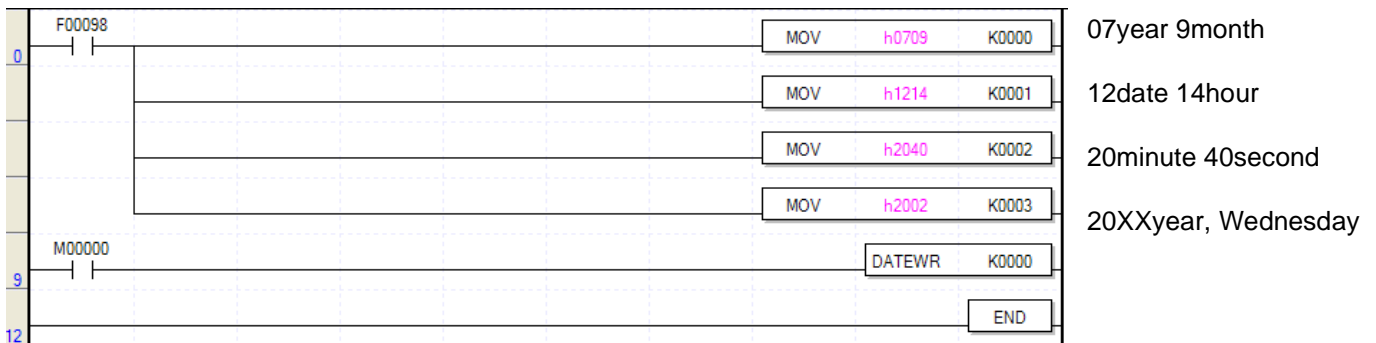

area	Content
K0000	Year, month
K0001	Date, hour
K0002	Minute, second
K0003	Centaury, day

Write clock data to temporary device (P, M, K, L, Z, U, D, R) and turn on/off input contact point M0000.
 (If date and day data is not matched, Write is not available.)
 Monitor and check the above special area (F053-F056)

(d) How to express the day

Number	0	1	2	3	4	5	6
Day	Sunday	Monday	Tuesday	Wednesday	Thursday	Friday	Saturday

(2) Deviation of clock data
 $\pm 2.2s / 1 d$

Remark
1) Initially, RTC may not have any clock data.
2) When using the CPU module, first make sure to set the accurate clock data.
3) If any data out of the clock data range is written into RTC, it does not work properly. i.e.) 14M 32D 25H
4) RTC may stop or have an error due to abnormal battery and other causes. The error is released if a new clock data is written.

6.13 External Memory Module

You can save the user program safely and download the program into the system when program is damaged without special manipulation by using external memory module.

6.13.1 Memory module specification

Item	XBO-M2MB	Ref.
Memory capacity	2MByte	
Memory type	Flash Memory	
Specification	USB supported, Program Read/Write	
Indicator	LED	1. RUN 2. WRITE 3. READ
Operating mode setup	Mode setup by rotary switch	
Operating power supply	RS-232C communication connector, USB connector	5V
Purpose	For moving	
Version	CPU O/S V5.00 or higher: use memory module V1.60 or higher. CPU O/S less than V5.00: No restriction.	

6.13.2 Memory module structure

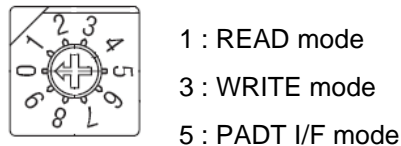
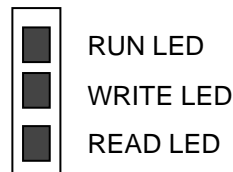
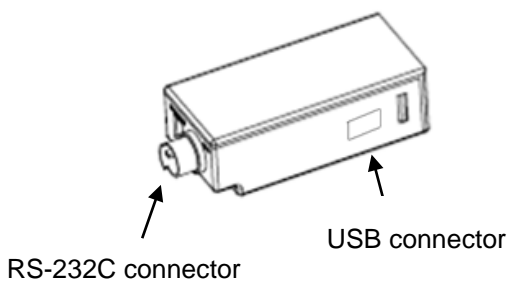

Note

- Memory module can be used for XGB (not supported for XGK/I/R)
- Memory module is not supported at the version below
(XBMS: V2.5 or less, XBCH: V1.8 or less, XECH: V1.2 or less)

6.13.3 How to use memory module

- (1) Save program, parameter, communication parameter at external memory module
 - (a) Set the switch of memory module as 1
 - (b) Install memory module at the RS-232C port of main unit
 - After installation, program and parameter (including communication) is saved into memory module and READ LED is on
 - If Saving program and parameter is complete, READ LED is off
 - (c) Separate memory module from main unit
- (2) Save user program of external memory module at main unit
 - (a) Set the operating mode of main unit as STOP
 - In RUN mode, you can't save program
 - (b) Set the switch of memory module as 3
 - (c) Install the memory module
 - Install it at the RS-232C port of the main unit.
 - PLC program and parameter (including communication) is written and WRITE LED is on
 - If saving program and parameter is complete, WRITE LED is off.
 - (d) If you change operation mode of PLC into RUN, PLC operates with program and parameter saved in memory module.

With the above handling, you can run PLC with program saved in memory module

- (3) Save program of XG5000 at the memory module
 - (a) Set the mode switch of XBO-M2MB as "5" and connect XBO-M2MB to USB port of PC
 - (b) Select Project → Write to Memory on XG5000 menu.

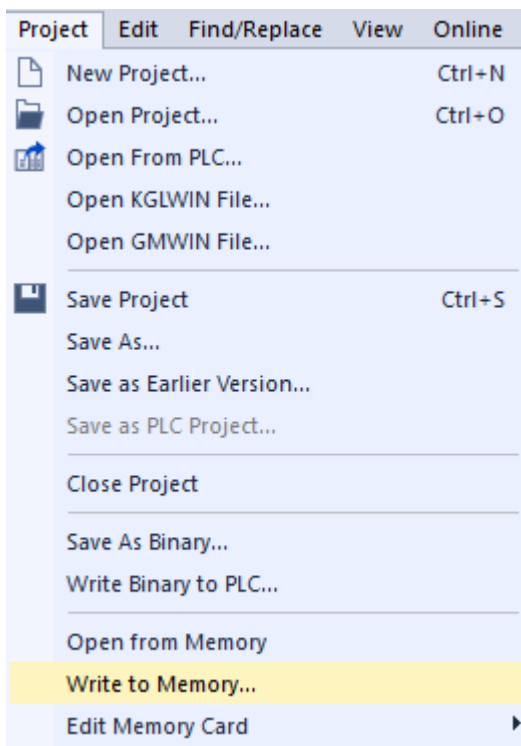

(c) 'Write' window is created as follows.

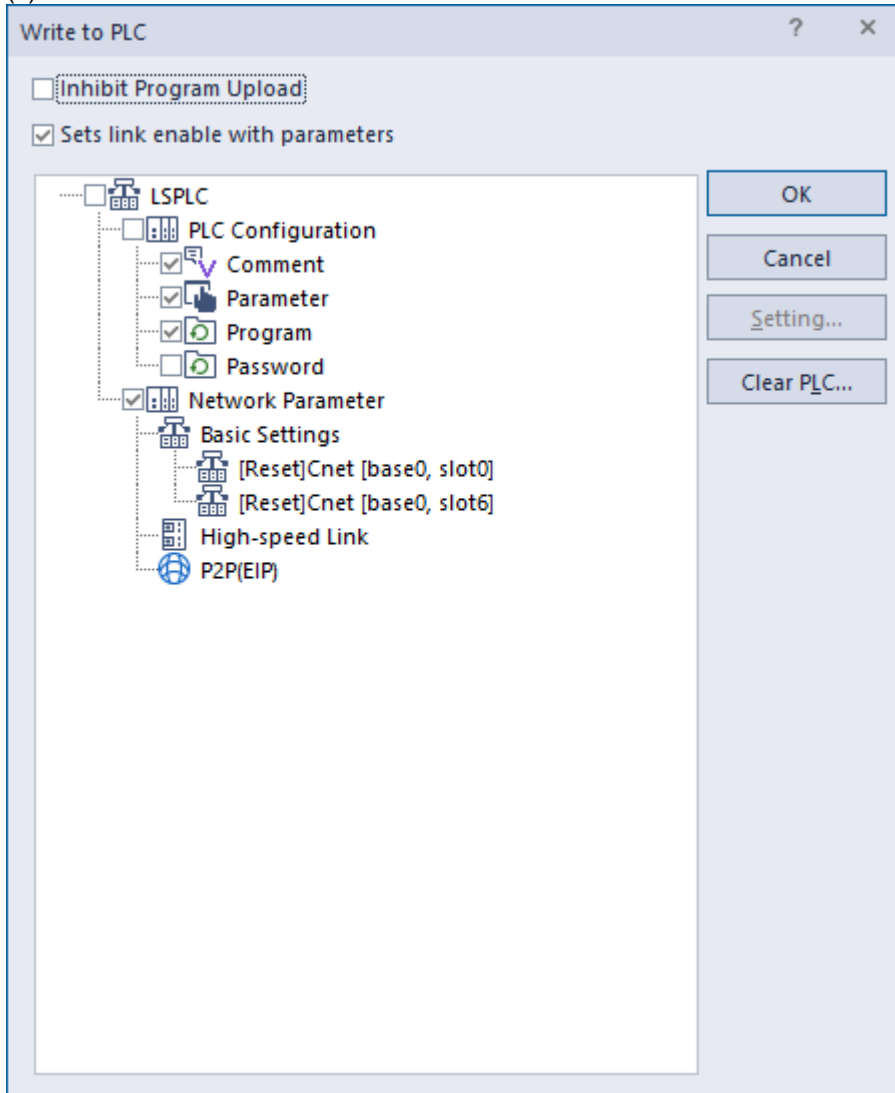

(d) "Writing completed" window appears.

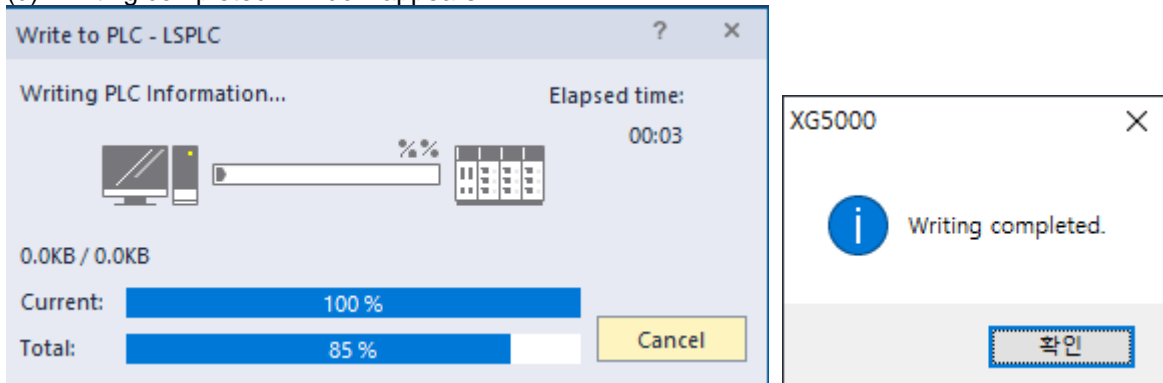

(e) With above method, through PADT, you can save program, parameter, communication parameter at XBO-M2MB

(4) Open from memory module

(a) Set the mode switch of XBO-M2MB as “5” and connect XBO-M2MB to USB port of PC

(b) Select “Project → Open from Memory” on XG5000 menu

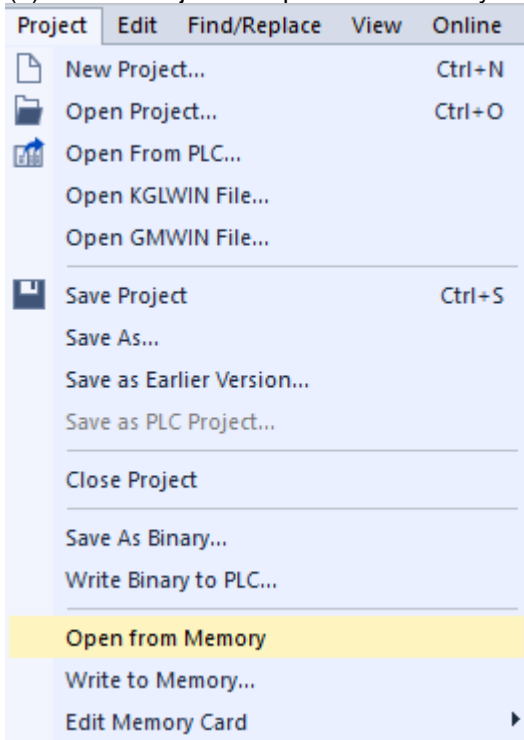

(c) “Read” window is created as follows.

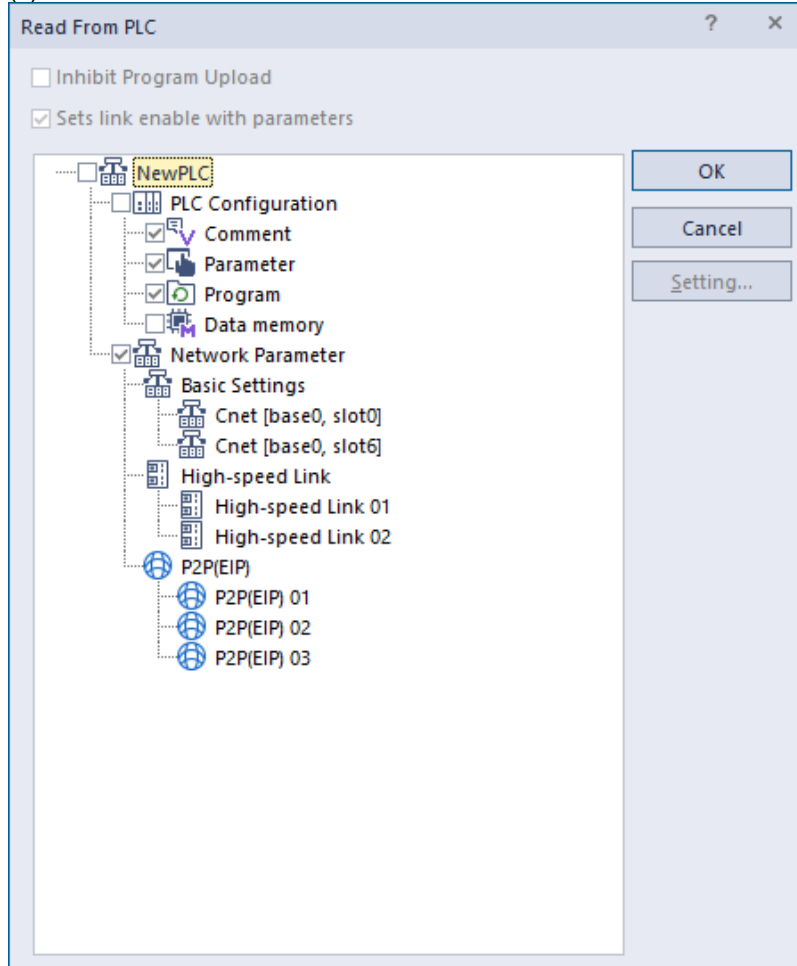

(d) "Reading is completed" window appears.

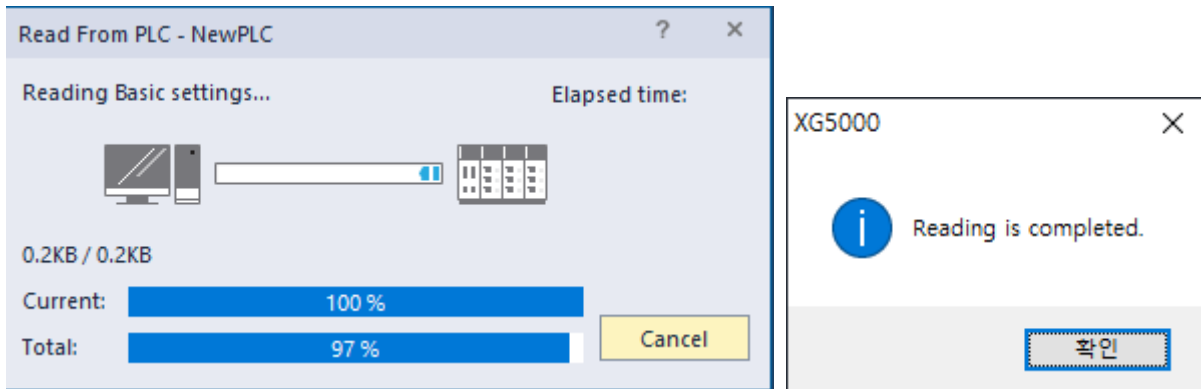

(e) With above method, through PADT, you can save program, parameter, communication parameter from XBO-M2MB

6.13.4 How to use when password is set

(1) When connecting PADT with memory module

(a) When setting password at program and writing program to memory module, it is saved according to rotary switch operating mode without functions cancelling the password

1) When writing program, check whether to use password at 'Write' window.

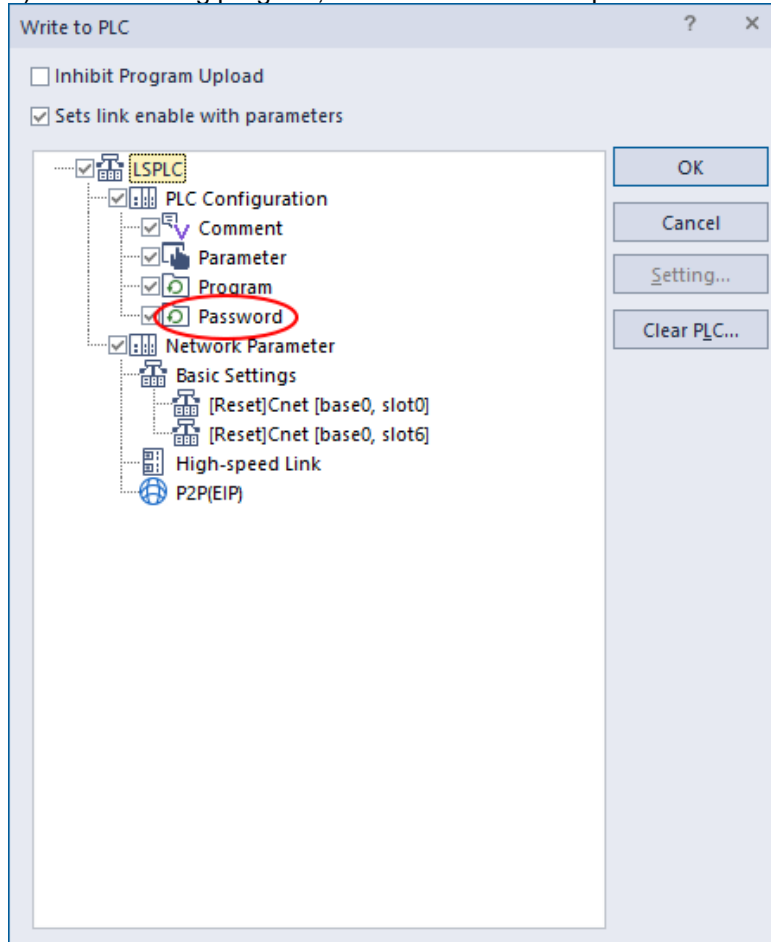

2) If you press 'OK' after setting password, program is saved at memory module with that password.

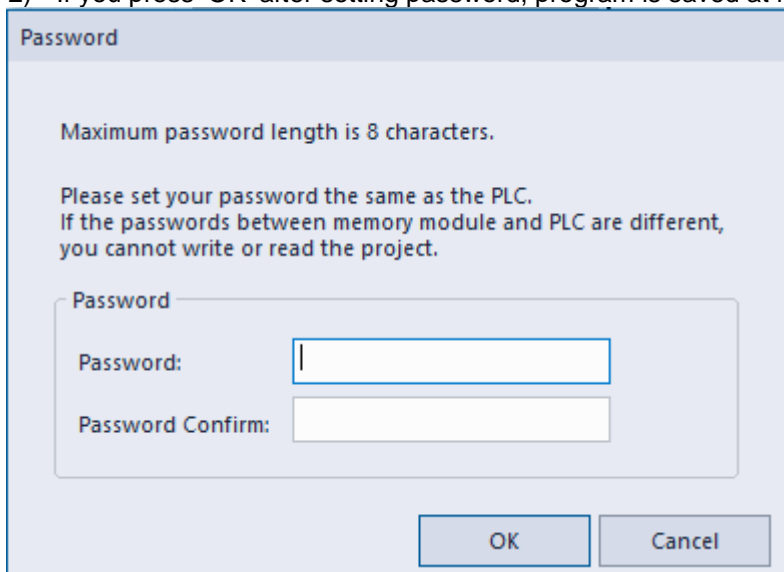

(b) When reading password-set program to PADT, screen appears, which is same as when password is set in PLC.

1) "Password" window is created.

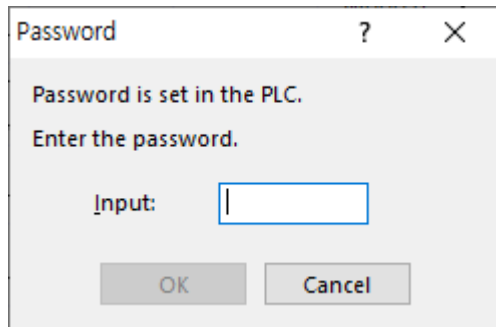

2) If you input password same as that in memory module, it reads program.

3) When password is incorrect, error message appears as follows.

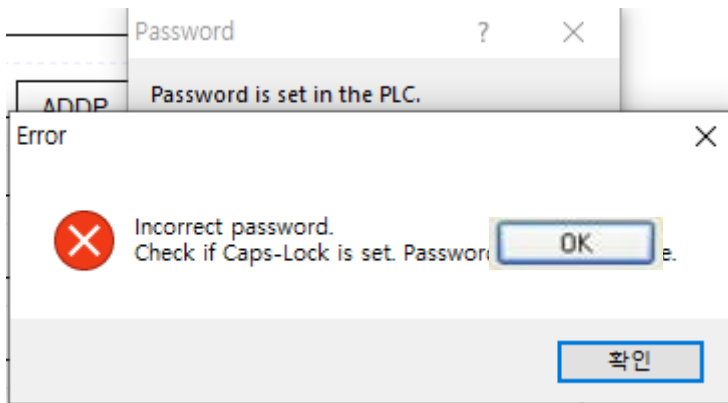

(2) Write to PLC by memory module

(a) When password of program in memory module is not set

- 1) When no password is set in PLC
 - Saves program of the memory module in PLC
- 2) When password is set in PLC
 - Writing is not executed

(b) When password of program in memory module is set

- 1) When no password is set in PLC
 - Writing to PLC is executed
 - But, password of the memory module is not written to PLC.
- 2) When password is set in PLC
 - When PLC password is same as that of the memory module, writing is executed.
 - When PLC password is not same as that of the memory module, writing is not executed. (WRITE LED flickers)

(3) Reading program in PLC to memory module

- (a) When password of program in PLC is not set
 - 1) When no password is set in the memory module
 - Reads program from PLC
 - 2) When password is set in the memory module
 - After reading, it clears password of the memory module
- (b) When password of program in PLC is set
 - 1) When no password is set in the memory module
 - Writing is not executed
 - 2) When password is set in the memory module
 - When PLC password is same as that of the memory module, writing is executed.
 - When PLC password is not same as that of the memory module, writing is not executed.

(4) When LED flickers

	Condition	LED
1	PLC type is not XGB	RUN LED flickers
2	Operating mode changes while being connected to PADT or PLC	RUN LED flickers
3	Connected to PADT while mode switch is "1"	READ LED flickers
4	PLC program upload is prohibited	READ LED flickers
5	You execute reading when password is set in PLC (when password is not same as that of memory module)	READ LED flickers
6	Connected to PADT while mode switch is "3"	WRITE LED flickers
7	You execute writing the memory module when PLC mode is RUN	WRITE LED flickers
8	Connected to the different type of PLC with the type set in the memory module	WRITE LED flickers
9	You executes writing when PLC password is not same as that of memory module	WRITE LED flickers

Note

- Memory module can cancel PLC password and read/write but can't set, delete and change the password.
- Do not run PLC while external memory module is connected to.
- Do not remove memory module while READ/WRITE LED is on.

6.14 Program Upload Prohibit

Program Upload Prohibit function prohibits from uploading comment, parameter, program saved on PLC. If Program Upload Prohibit function is set, you can't open from PLC, read PLC and compare PLC.

(1) How to set

(a) Click 『Online』 - 『Write』

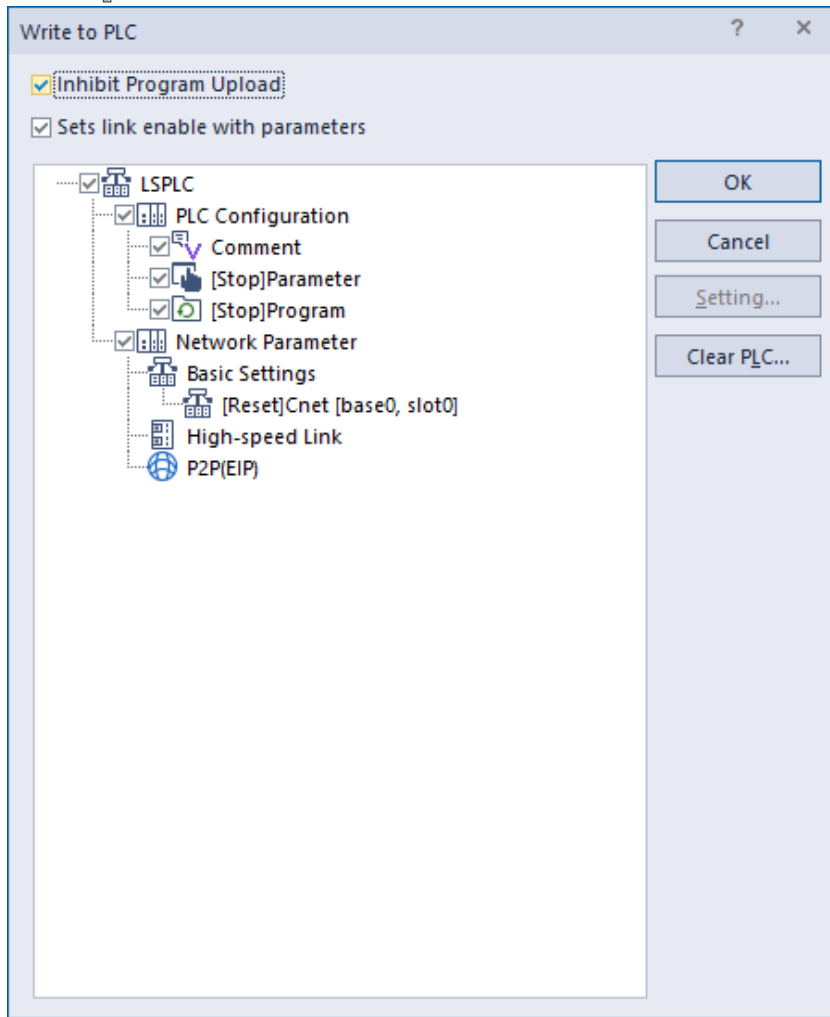

(b) Select "Program" to activate "Program Upload Prohibit"

(c) Select "Program Upload Prohibit" and click OK.

(2) When reading PLC is prohibited, if you try to read PLC, the following dialog box appears. After releasing Program Upload Prohibit, execute reading.

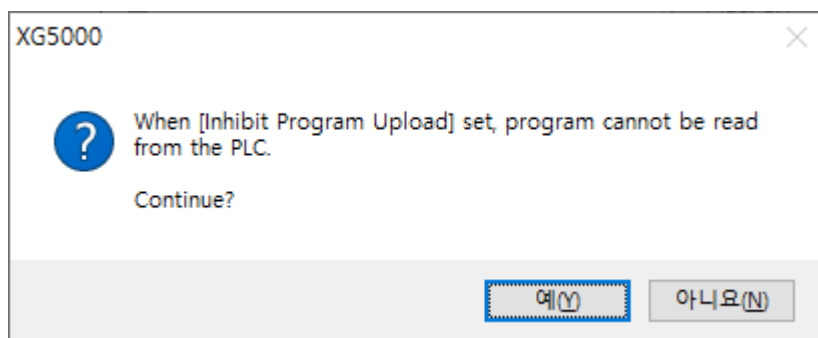

- (3) How to release Program Upload Prohibit
(a) Click 『Online』 - 『Write』 .

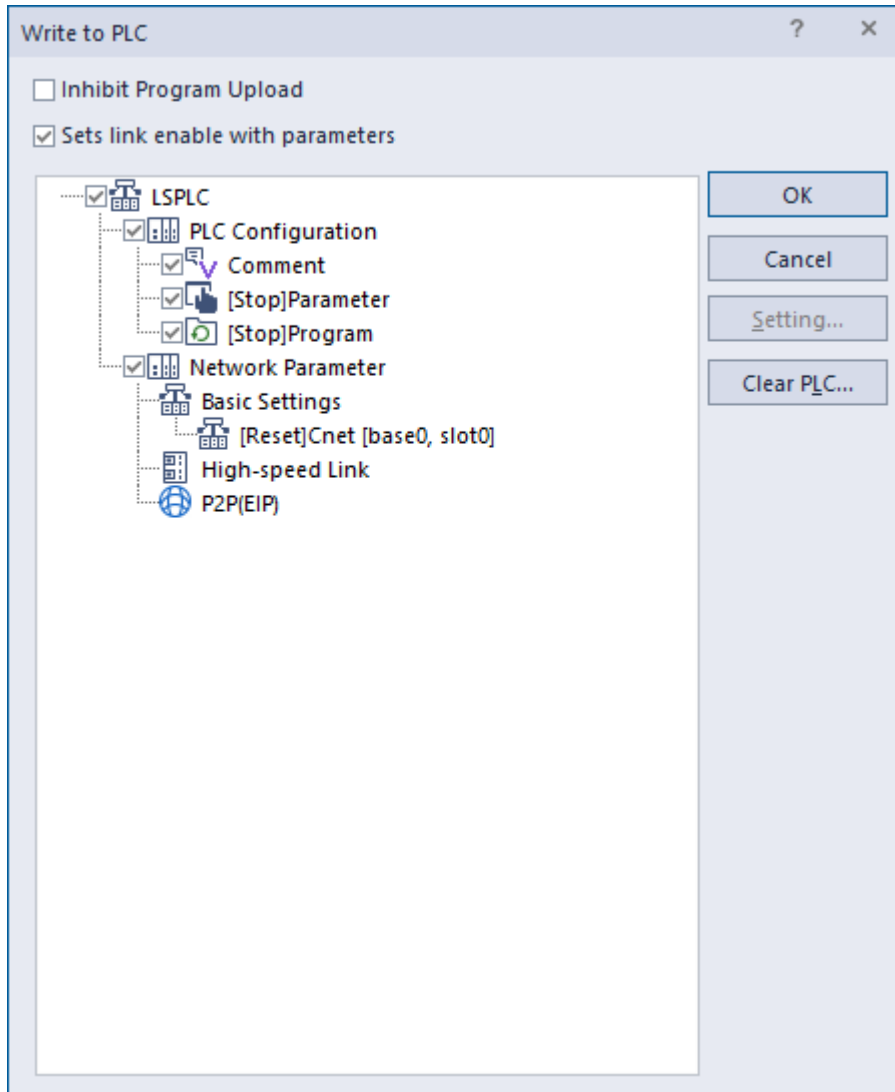

- (b) Release Program Upload Prohibit and click OK.

6.15 Clear All PLC

Clear All PLC function clears parameter, program, data, password saved on PLC

(1) How to clear all PLC

(a) Click 『Online』 - 『Clear All PLC』 .

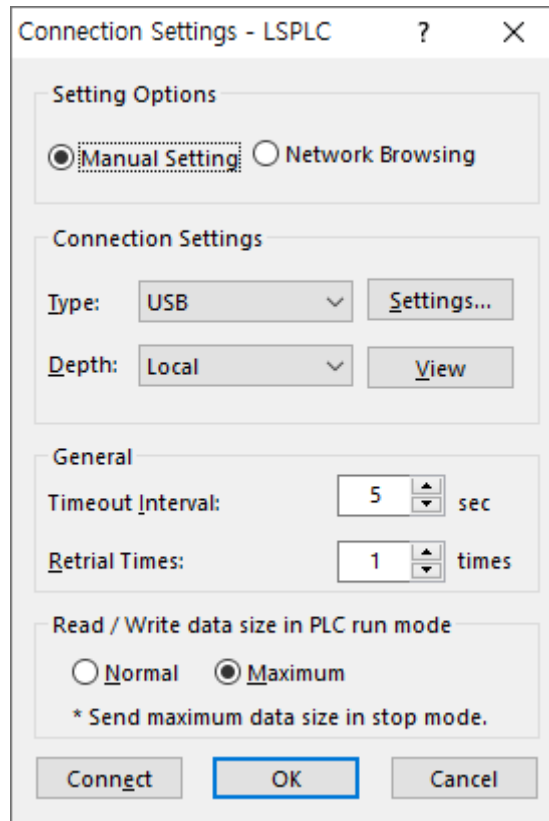

(b) After selection connection method, click 『Connect』 or 『OK』 .

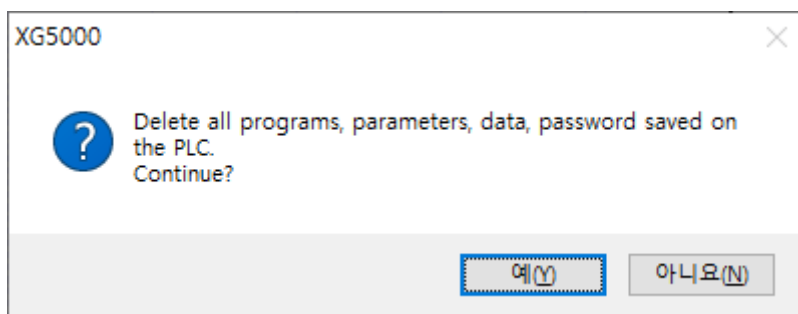

(c) If you select 『Yes』 on the dialog box, PLC program, parameter, data, password will be deleted.

Note

- Clear All PLC function can be executed though not connected.
- If you use Clear All PLC function, password will be deleted. So be careful.
- In case you lose password, use this function to clear password.

6.16 Password Setting per Program Block

Password Setting per Program Block function sets password for each program block. You should input password to open program.

- (1) How to set program block password
 - (a) Click 『Properties』 after selecting program in project window.
 - (b) Click password tap.

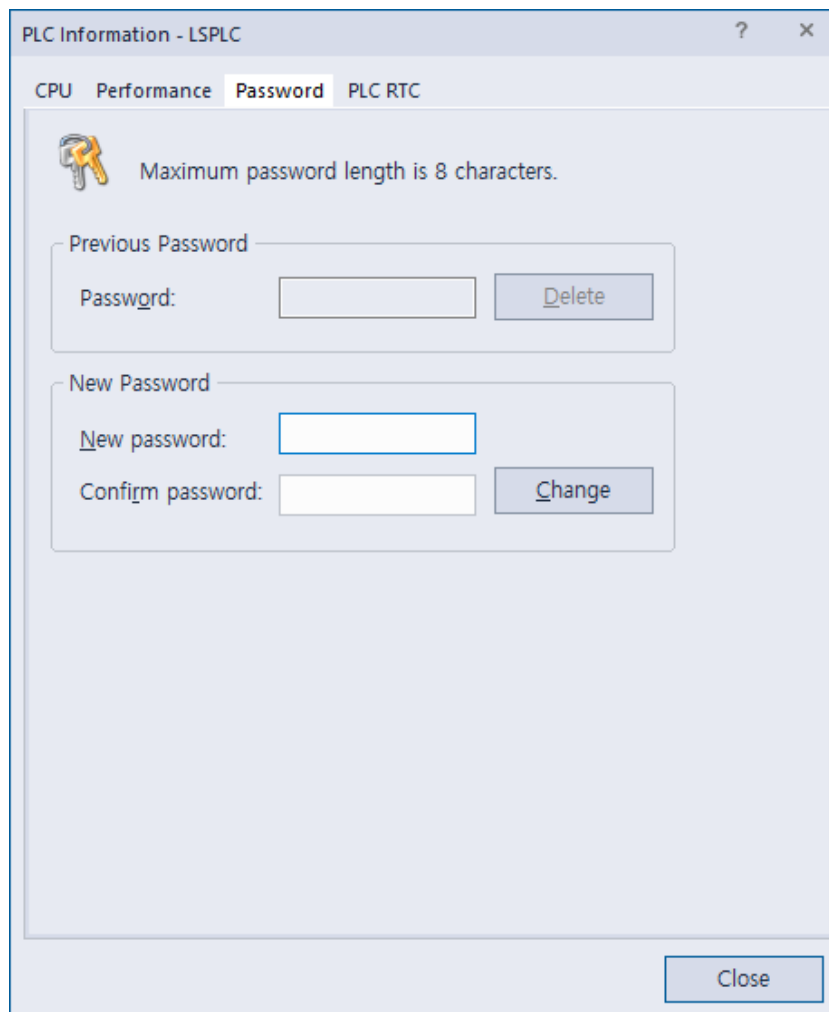

- (c) Click 『OK』 after inputting new password.

(2) Opening password-set program

- (a) When you open password-set program, the following window appears.

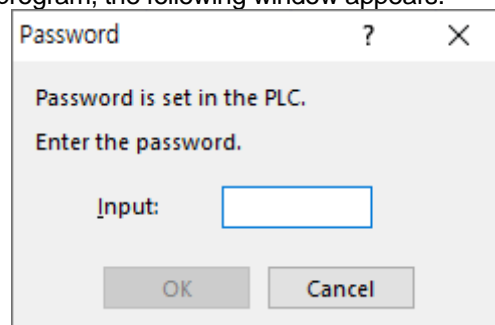

- (b) After inputting correct password, click 『OK』 to open program.

- (3) How to delete program block password
- (a) After program in project window, click 『Properties』 .
 - (b) Click password tap.

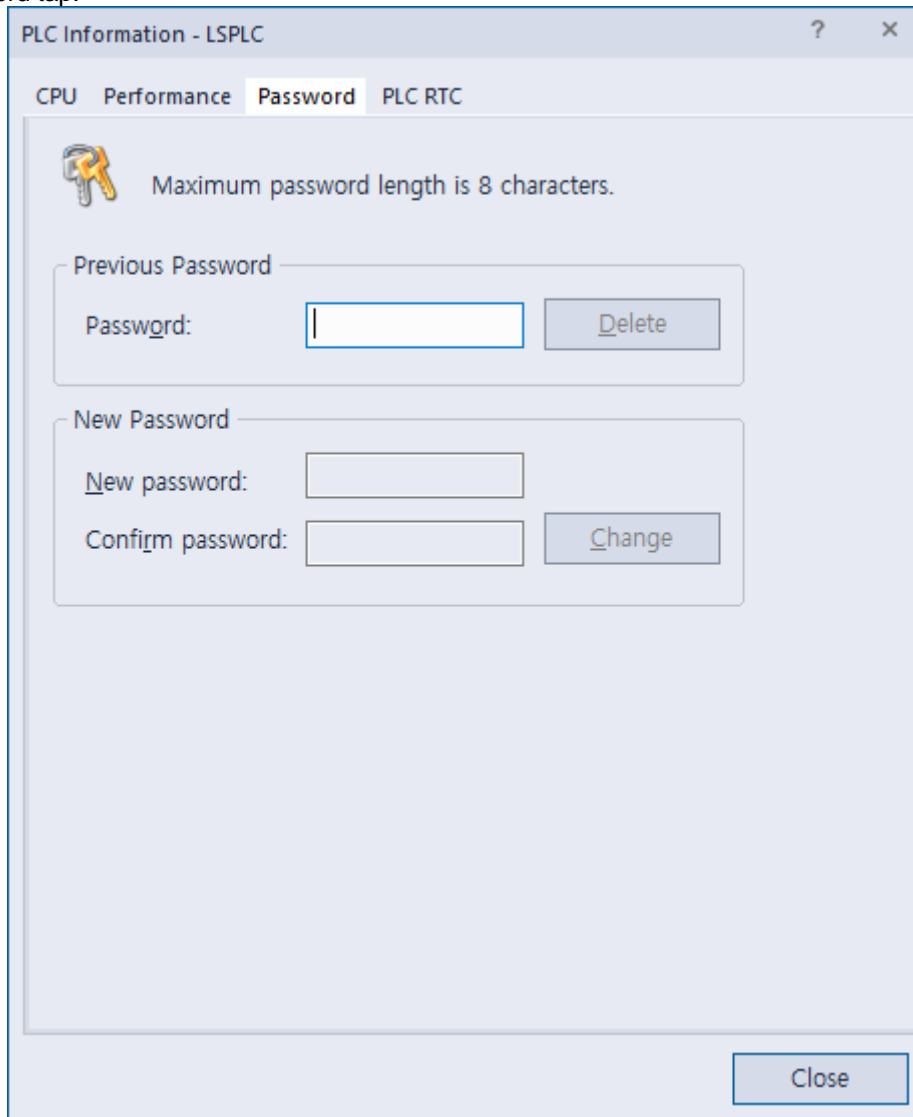

- (c) After inputting previous password, click 『Delete』 .
- (d) Click 『OK』 .

Chapter 7 Input/Output Specifications

7.1 Introduction

Here describes the notices when selecting digital I/O module used for XGB series.

- 1) For the type of digital input, there are two types such as current sink input and current source input.
- 2) The number of max. Simultaneous input contact point is different according to module type. It depends on the input voltage, ambient temperature. Use input module after checking the specification.
- 3) When response to high speed input is necessary, use interrupt input contact point. Up to 8 interrupt points are supported.
- 4) In case that open/close frequency is high or it is used for conductive load open/close, use Transistor output module or triac output module as the durability of Relay Output Module shall be reduced.
- 5) For output module to run the conductive (L) load, max. open/close frequency should be used by 1second On, 1 second Off.
- 6) For output module, in case that counter timer using DC/DC Converter as a load was used, Inrush current may flow in a certain cycle when it is ON or during operation. In this case, if average current is selected, it may cause the failure. Accordingly, if the previous load was used, it is recommended to connect resistor or inductor to the load in serial in order to reduce the impact of Inrush current or use the large module having a max. load current value.

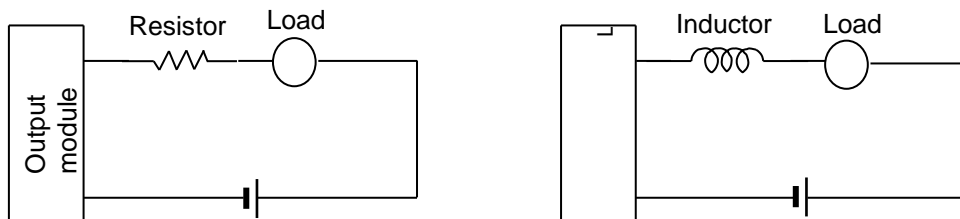

- 7) Relay life of Relay output module is shown as below.
 Max. life of Relay used in Relay output module is shown as below.

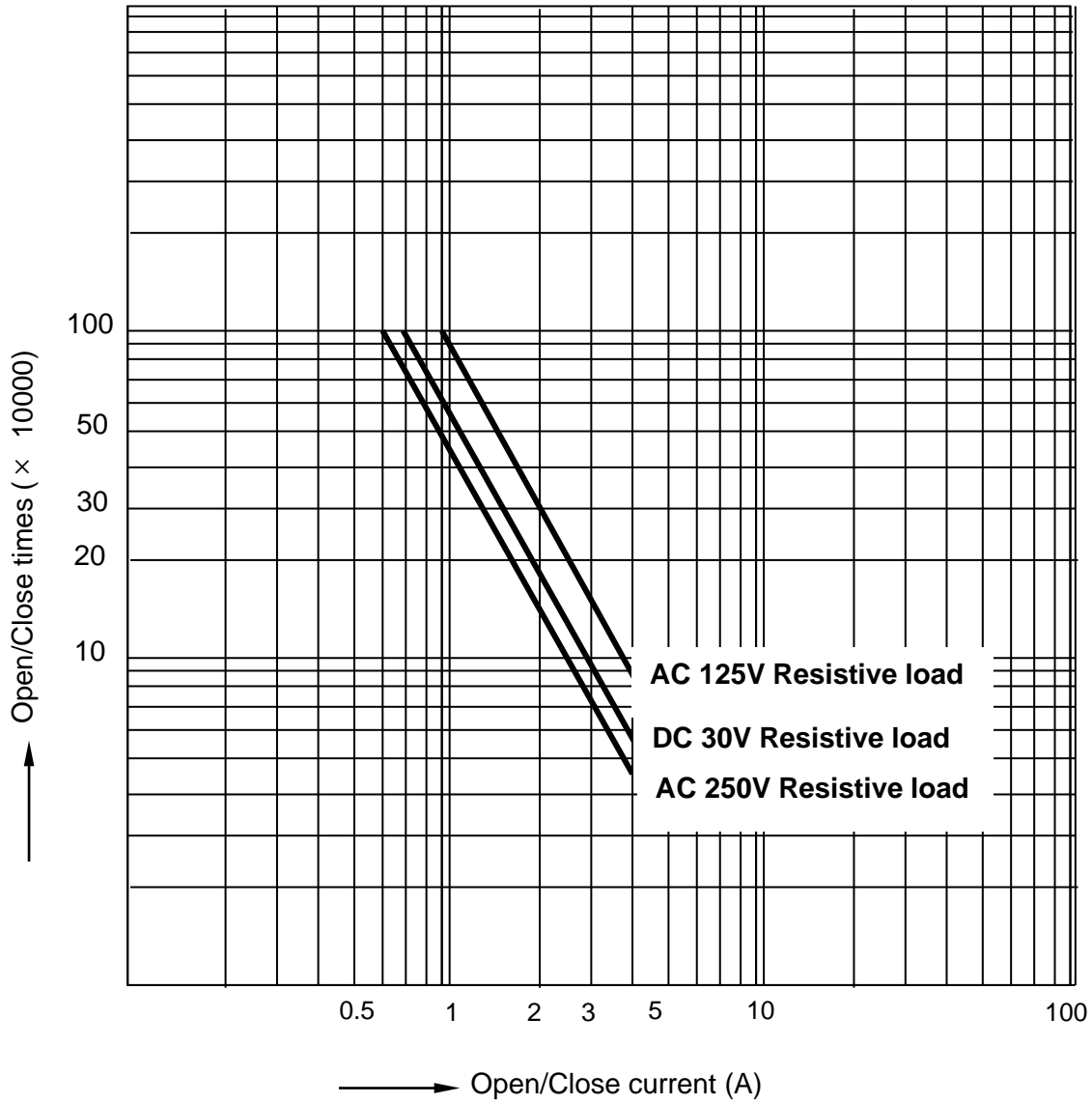

Chapter 7. Input/Output Specifications

(8) Terminal blocks are of barrier type and pluggable type, and pluggable terminal blocks have screw type and push-in type depending on the connection method.

1) Barrier terminal block

As a terminal block mainly applied to the XGB compact type basic unit, crimp terminals with insulation sleeves cannot be used. Crimp terminals suitable for connection to terminal blocks are as follows.

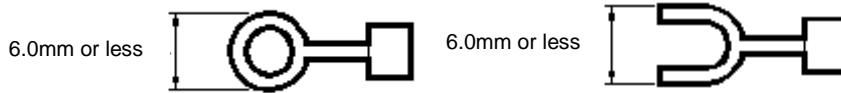

For the size of the wire connected to the terminal block, use a stranded wire of 0.3 to 0.75 mm² and a thickness of 2.8 mm or less. Please note that the allowable current may differ depending on the insulation thickness of the wire.

The tightening torques of the module fixing screws and terminal block screws must be within the following ranges.

Coupling position	Coupling torque range
IO module terminal strip screw (M3 screw)	42 ~ 58 N·cm
IO module terminal strip fixation screw (M3 screw)	66 ~ 89 N·cm
IO module external connector(M2 screw)	18 ~ 22 N·cm

2) Screw connection type plug (PCB plug, Screw connection):XBE-xx08A, XBE-xx16A

As a terminal block mainly applied to the XGB compact type basic unit, crimp terminals with insulation

① Wire size

Number of wires per contact	single wire	stranded wire	When using ferrules with plastic sleeves	When using ferrules without plastic sleeves
1	0.2 ~ 1.5 mm ²	0.2 ~ 1.5 mm ²	0.25 ~ 0.5 mm ²	0.25 ~ 1.5 mm ²
2	0.75 mm ²	0.75 mm ²	0.5 mm ² (Twin Ferrules)	0.25 ~ 0.34 mm ²

② Ferrule size

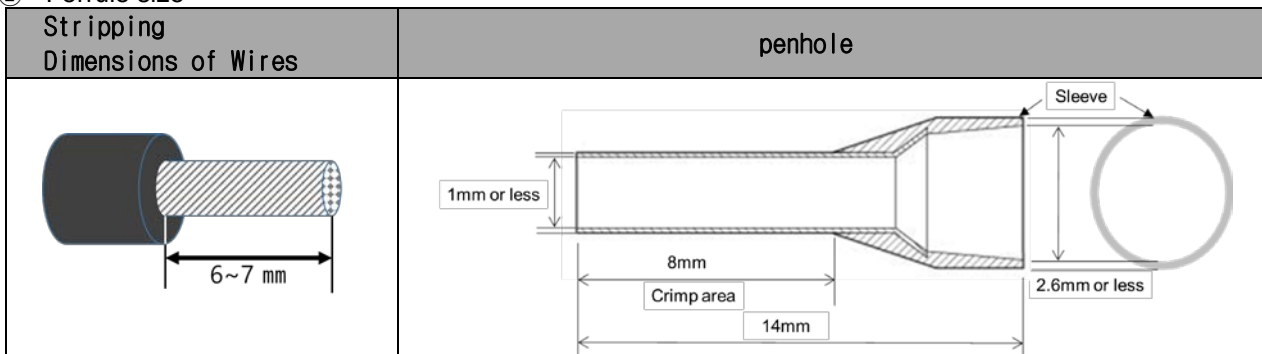

③ Recommended ferrule

Manufacturer	model name	line size	crimping tool
GLW GmbH	DN00508D	0.5 mm ²	CO225 Or CAP4
	DN00308D	0.34 mm ²	
	DN00208D	0.25 mm ²	

Peel off about 6-7 mm of the sheath from the end of the wire and connect it to the ferrule. Excessive stripping of the sheath can result in poor contact with the crimp area of the ferrule. Tighten the terminal block

screws as follows.

Screw thread	M2
Flat screwdriver size	0.4 x 2.5
Tightening torque	0.2 N · m

9) Relay life graph is not written based on real use. (This is not a guaranteed value). So consider margin. Relay life is specified under following condition.

- (a) Rated voltage, load: 3 million times: 100 million times
- (b) 200V AC 1.5A, 240V AC 1A (COS ϕ =0.7): 1 million times
- (c) 200V AC 0.4A, 240V AC 0.3A (COS ϕ =0.7): 3 million times
- (d) 200V AC 1A, 240V AC 0.5A (COS ϕ =0.35): 1 million times
- (e) 200V AC 0.3A, 240V AC 0.15A (COS ϕ =0.35): 3 million times
- (f) 24V DC 1A, 100V DC 0.1A (L/R=7ms): 1million times
- (g) 24V DC 0.3A, 100V DC 0.03A (L/R=7ms): 3million times

10) Noise can be inserted into input module. To prevent this noise, the user can set filter for input delay in parameter. Consider the environment and set the input filter time.

Input filter time (ms)	Noise signal pulse size (ms)	Reference
1	0.3	
3	1.8	Initial value
5	3	
10	6	
20	12	
70	45	
100	60	

Chapter 7. Input/Output Specifications

(a) Setting input filter

1) Click I/O Parameter in the project window of XG5000

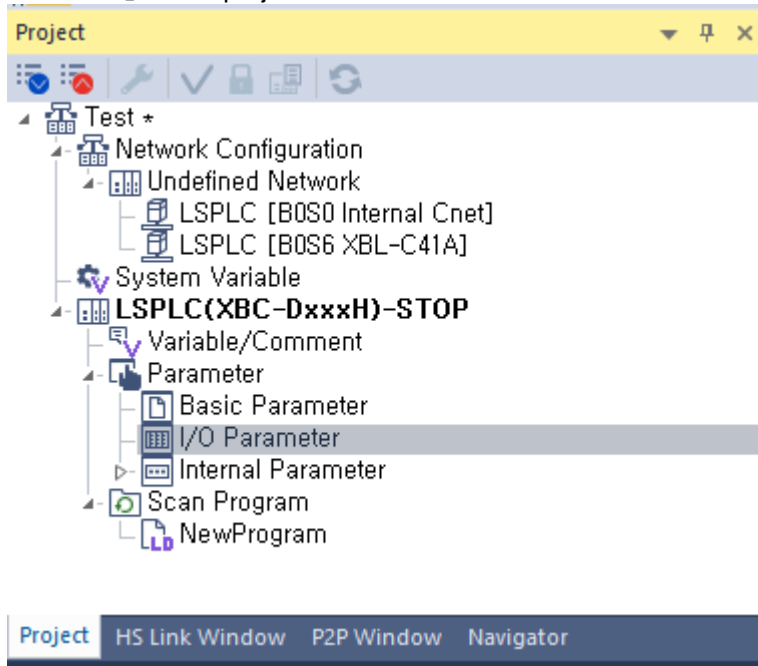

2) Click 『Module』 at the slot location.

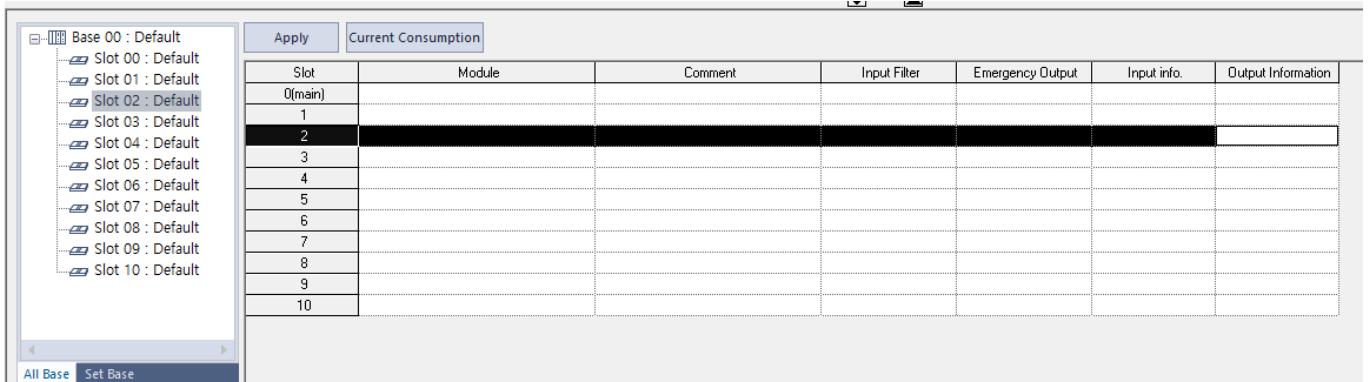

3) Set I/O module really equipped.

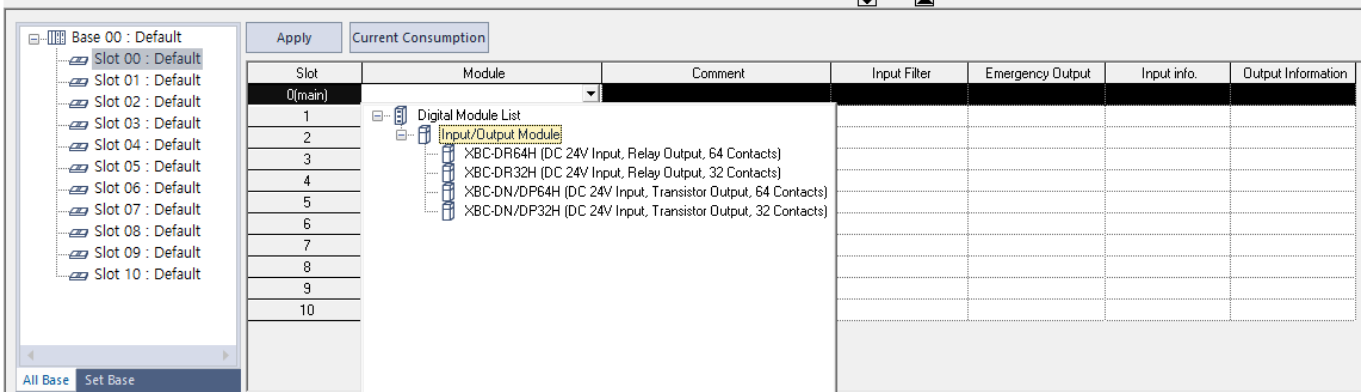

4) After setting I/O module, click Input Filter.

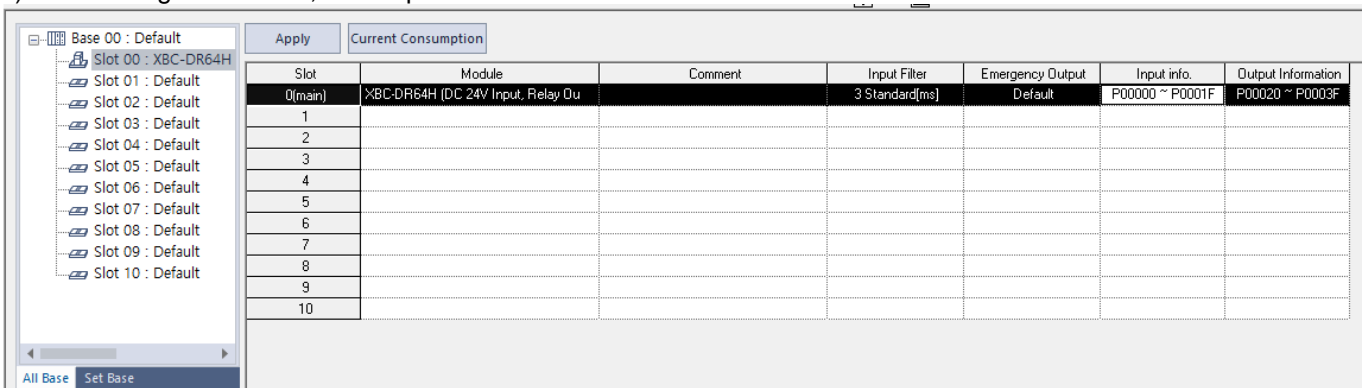

5) Set filter value.

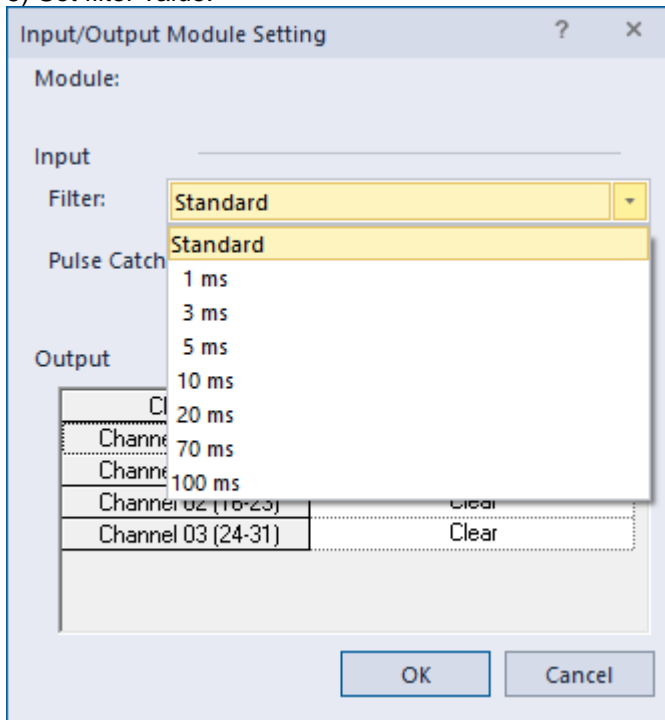

Chapter 7. Input/Output Specifications

(b) Setting output status in case of error

1) Click Emergency Out in the I/O parameter setting window.

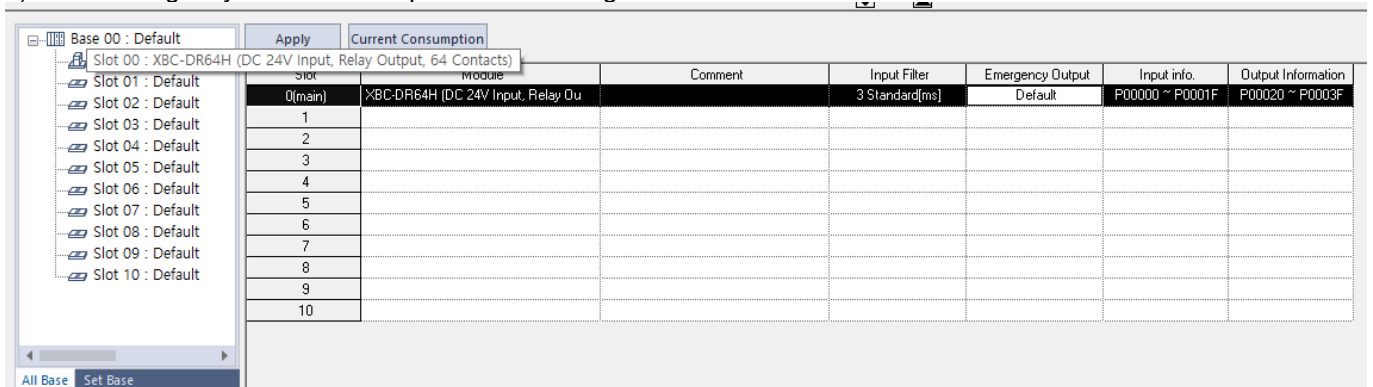

2) Click Emergency Output.

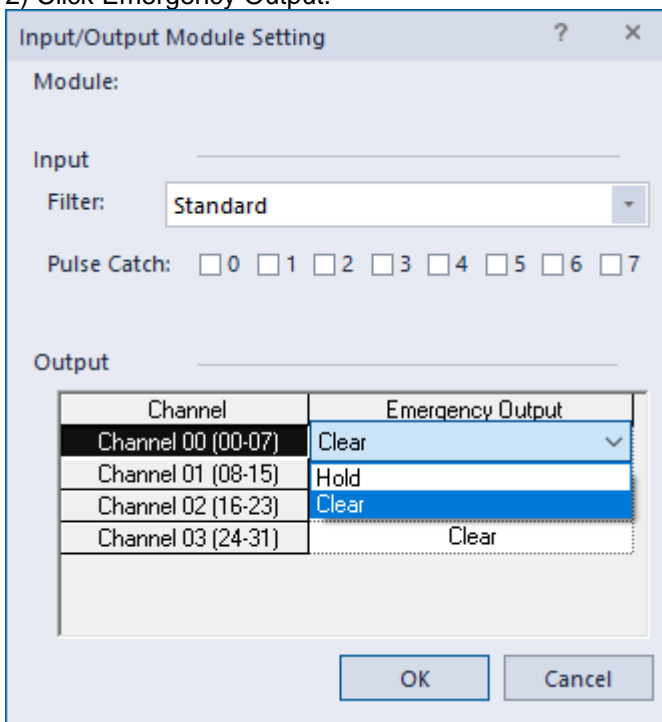

If it is selected as Clear, the output will be Off and if Hold is selected, the output will be kept.

7.2 Basic Digital Input Unit Specifications
7.2.1 XBM-DR16S input unit (Source/Sink type)

Model		Basic unit				
Specification		XBM-DR16S				
Input point		8 point				
Insulation method		Photo coupler insulation				
Rated input voltage		DC24V				
Rated input current		About 4 mA (00~03: About 7 mA)				
Operation voltage range		DC20.4~28.8V (ripple rate < 5%)				
On Voltage/Current		DC19V or higher/ 3 mA or higher				
Off Voltage/Current		DC6V or lower/ 1 mA or lower				
Input resistance		About 5.6 kΩ (P00~P03: about 3.3 kΩ)				
Response time	Off → On	1/3/5/10/20/70/100 ms (set by I/O parameter) Default: 3 ms				
	On → Off					
Insulation pressure		AC560Vrms / 3Cycle (altitude 2000m)				
Insulation resistance		10 MΩ or more by Megohmmeter				
Common Method		8 point / COM				
Proper cable size		Twisted pair 0.3~0.75 mm ² (external diameter 2.8 mm or less)				
Current consumption (mA)		180 mA (When Input On LED On)				
Operation indicator		Input On, LED On				
External connection method		9 pin terminal block connector				
Weight		140g				
Circuit configuration				No.	Contact	Type
<p>Terminal block NO.</p>				TB1	00	
				TB2	01	
				TB3	02	
				TB4	03	
				TB5	04	
				TB6	05	
				TB7	06	
				TB8	07	
				TB9	COM	

7.2.2 XBM-DN16S input unit (Source/Sink type)

Specification		Model	Basic unit			
			XBM-DN16S			
Input point		8 point				
Insulation method		Photo coupler insulation				
Rated input voltage		DC24V				
Rated input current		About 4 mA (Contact point 0~3: About 7 mA)				
Operation voltage range		DC20.4~28.8V (ripple rate < 5%)				
On Voltage/Current		DC19V or higher / 3 mA or higher				
Off Voltage/Current		DC6V or less / 1 mA or less				
Input resistance		About 5.6 kΩ (P00~P03: About 3.3 kΩ)				
Response time	Off → On	1/3/5/10/20/70/100 ms (set by I/O parameter) Default: 3 ms				
	On → Off					
Insulation pressure		AC560Vrms / 3Cycle (altitude 2000m)				
Insulation resistance		10 MΩ or more by Megohmmeter				
Common method		8 point / COM				
Proper cable size		0.3 mm ²				
Current consumption		180 mA (when all point On)				
Operation indicator		Input On, LED On				
External connection method		20 pin connector				
Weight		100g				
Circuit configuration		No.	Contact	No.	Contact	Type
<p>Connector no.</p>		B10	00	A10	NC	
		B09	01	A09	NC	
		B08	02	A08	NC	
		B07	03	A07	NC	
		B06	04	A06	NC	
		B05	05	A05	NC	
		B04	06	A04	NC	
		B03	07	A03	NC	
		B02	COM	A02	NC	
		B01	COM	A01	NC	

7.2.3 XBM-DN32S input unit (Source/Sink type)

Model		Basic unit							
Specification		XBM-DN32S							
Input point		16 point							
Insulation method		Photo coupler insulation							
Rated input voltage		DC24V							
Rated input current		About 4 mA (Contact point 0~3: About 7 mA)							
Operation voltage range		DC20.4~28.8V (ripple rate < 5%)							
On Voltage/Current		DC19V or higher / 3 mA or higher							
Off Voltage/Current		DC6V or less / 1 mA or less							
Input resistance		About 5.6 kΩ (P00~P03: About 3.3 kΩ)							
Response time	Off → On	1/3/5/10/20/70/100 ms (set by I/O parameter) Default: 3 ms							
	On → Off								
Insulation pressure		AC560Vrms / 3Cycle (altitude 2000m)							
Insulation resistance		10 MΩ or more by Megohmmeter							
Common method		16 point / COM							
Proper cable size		0.3 mm ²							
Current consumption		200 mA (when all point On)							
Operation indicator		Input On, LED On							
External connection method		20 pin connector							
Weight		110g							
Circuit configuration					No.	Contact	No.	Contact	Type
					B10	00	A10	08	
					B09	01	A09	09	
					B08	02	A08	0A	
					B07	03	A07	0B	
					B06	04	A06	0C	
					B05	05	A05	0D	
					B04	06	A04	0E	
					B03	07	A03	0F	
					B02	COM	A02	COM	
					B01	COM	A01	COM	

7.2.4 XBC-DR32H / XBC-DN32H input unit (Source/Sink type)

Model		Basic unit						
		XBC-DR32H/(DC)	XBC-DN32H/(DC)					
Input point		16 point						
Insulation method		Photo coupler insulation						
Rated input voltage		DC24V						
Rated input current		About 4 mA (Contact point 0~3: About 7 mA)						
Operation voltage range		DC20.4~28.8V (ripple rate < 5%)						
On Voltage/Current		DC19V or higher / 3 mA or higher						
Off Voltage/Current		DC6V or less / 1 mA or less						
Input resistance		About 5.6 kΩ (P00~P03: About 3.3 kΩ)						
Response time	Off → On	1/3/5/10/20/70/100 ms (set by I/O parameter) Default: 3 ms						
	On → Off							
Insulation pressure		AC560Vrms / 3Cycle (altitude 2000m)						
Insulation resistance		10 MΩ or more by Megohmmeter						
Common method		16 point / COM						
Proper cable size		0.3 mm ²						
Current consumption		200 mA (when all point On)						
Operation indicator		Input On, LED On						
External connection method		24 points connecting connector (M3 X 6 screw)						
Weight		600g	500g					
Circuit configuration								
		No.	Contact	No.	Contact	Type		
		TB1		TB1	RX			
		TB2	485+	TB3	TX			
		TB4	485-	TB5	SG			
		TB6	00	TB7	01			
		TB8	02	TB9	03			
		TB10	04	TB11	05			
		TB12	06	TB13	07			
		TB14	08	TB15	09			
		TB16	0A	TB17	0B			
		TB18	0C	TB19	0D			
		TB20	0E	TB21	0F			
		TB22	COM	TB23	24G			
		TB24	24V					
				TB2	485+	TB1	RX	
				TB4	485-	TB3	TX	
				TB6	P00	TB5	SG	
				TB8	P02	TB7	P01	
				TB10	P04	TB9	P03	
				TB12	P06	TB11	P05	
				TB14	P08	TB13	P07	
				TB16	P0A	TB15	P09	
				TB18	POC	TB17	P0B	
				TB20	POE	TB19	P0D	
		TB22	COM	TB21	P0F			
		TB24	24V	TB23	24G			

7.2.5 XBC-DR64H / XBC-DN64H input unit (Source/Sink Type)

Model		Basic unit								
		XBC-DR64H(/DC)	XBC-DN64H(/DC)							
Specification										
Input point		32 point								
Insulation method		Photo coupler insulation								
Rated input voltage		DC24V								
Rated input current		About 4 mA (Contact point 0~3: About 7 mA)								
Operation voltage range		DC20.4~28.8V (ripple rate < 5%)								
On Voltage/Current		DC19V or higher / 3 mA or higher								
Off Voltage/Current		DC6V or less / 1 mA or less								
Input resistance		About 5.6 kΩ (P00~P03: About 3.3 kΩ)								
Response time	Off → On	1/3/5/10/20/70/100 ms (set by CPU parameter) Default: 3 ms								
	On → Off									
Insulation pressure		AC560Vrms / 3Cycle (altitude 2000m)								
Insulation resistance		10 MΩ or more by Megohmmeter								
Common method		16 point / COM								
Proper cable size		0.3 mm ²								
Current consumption		200 mA (when all point On)								
Operation indicator		Input On, LED On								
External connection method		42 point connecting connector (M3 X 6 screw)								
Weight		900g	800g							
Circuit configuration		No.	contact	No.	contact	type				
<p>Terminal block no.</p>		TB2	485+	TB1	RX	TB2	RX	TB1		
		TB4	485-	TB3	TX	TB4	TX	TB3		
		TB6	00	TB5	SG	TB6	SG	TB5		
		TB8	02	TB7	01	TB8	P00	P01	TB7	
		TB10	04	TB9	03	TB10	P02	P03	TB9	
		TB12	06	TB11	05	TB12	P04	P05	TB11	
		TB14	08	TB13	07	TB14	P06	P07	TB13	
		TB16	0A	TB15	09	TB16	P08	P09	TB15	
		TB18	0C	TB17	0B	TB18	POA	POB	TB17	
		TB20	0E	TB19	0D	TB20	POC	POD	TB19	
		TB22	COM0	TB21	0F	TB22	POE	POF	TB21	
		TB24	10	TB23	NC	TB24	COM0	NC	TB23	
		TB26	12	TB25	11	TB26	P10	P11	TB25	
		TB28	14	TB27	13	TB28	P12	P13	TB27	
		TB30	16	TB29	15	TB30	P14	P15	TB29	
		TB32	18	TB31	17	TB32	P16	P17	TB31	
		TB34	1A	TB33	19	TB34	P18	P19	TB33	
		TB36	1C	TB35	1B	TB36	P1A	P1B	TB35	
		TB38	1E	TB37	1D	TB38	P1C	P1D	TB37	
		TB40	COM1	TB39	1F	TB40	P1E	P1F	TB39	
		TB42	24V	TB41	24G	TB42	COM	24G	TB41	

7.3 Basic Digital Output Unit Specification

7.3.1 XBM-DR16S relay output unit

Model		Basic unit				
Specification		XBM-DR16S				
Output point		8 point				
Insulation method		Relay insulation				
Rated load voltage / current		DC24V 2A(Resistive load) / AC220V 2A(COSΨ = 1), 5A/COM				
Min. load voltage/current		DC5V / 1 mA				
Max. load voltage/current		AC250V, DC125V				
Off leakage current		0.1 mA (AC220V, 60 Hz)				
Max. On/Off frequency		3,600 times/hr				
Surge absorber		None				
Service life	Mechanical	20 millions times or more				
	Electrical	Rated load voltage / current 100,000 times or more				
		AC200V / 1.5A, AC240V / 1A (COSΨ = 0.7) 100,000 times or more				
		AC200V / 1A, AC240V / 0.5A (COSΨ = 0.35) 100,000 times or more				
		DC24V / 1A, DC100V / 0.1A (L / R = 7 ms) 100,000 times or more				
Response time	Off → On	10 ms or less				
	On → Off	12 ms or less				
Common method		8 point / COM				
Proper cable size		Twisted pair0.3~0.75 mm ² (External diameter 2.8 mm or less)				
Current consumption		360 mA (when all point On)				
Operation indicator		Output On, LED On				
External connection method		9 point terminal block connector				
Weight		140g				
Circuit configuration				No.	Contact	Type
				TB1	20	
				TB2	21	
				TB3	22	
				TB4	23	
				TB5	24	
				TB6	25	
				TB7	26	
				TB8	27	
				TB9	COM	

7.3.2 XBM-DN16S transistor output unit (Sink type)

Model		Basic unit		
Specification		XBM-DN16S		
Output point		8 point		
Insulation method		Photo coupler insulation		
Rated load voltage		DC 12 / 24V		
Load voltage range		DC 10.2 ~ 26.4V		
Max. load voltage		General output: 0.2A/ 1point, Output for positioning (P20, P21): 0.1A/ 1 point, 2A/1COM		
Off leakage current		0.1 mA or less		
Max. inrush current		4A / 10 ms or less		
Max. voltage drop (On)		DC 0.4V or less		
Surge absorber		Zener Diode		
Response time	Off → On	1 ms or less		
	On → Off	1 ms or less (Rated load, resistive load)		
Common method		8 point / COM		
Proper cable size		0.3 mm ²		
Current consumption		180 mA (when all point On)		
External power supply	Voltage	DC12/24V ± 10% (ripple voltage 4 Vp-p or less)		
	Current	10 mA or less (DC24V connection)		
Operation indicator		Output On, LED On		
External connection method		20 pin connector		
Weight		100g		
Circuit configuration				
		No.	Contact	Type
		B10	20	
		B09	21	
		B08	22	
		B07	23	
		B06	24	
		B05	25	
		B04	26	
		B03	27	
		B02	DC12 /24V	
		B01	COM	
		A10	NC	
		A09	NC	
		A08	NC	
		A07	NC	
		A06	NC	
A05	NC			
A04	NC			
A03	NC			
A02	COM			
A01				

7.3.3 XBM-DN32S transistor output unit (Sink type)

Specification		Model	Basic unit		
			XBM-DN32S		
Output point		16 point			
Insulation method		Photo coupler insulation			
Rated load voltage		DC 12 / 24V			
Load voltage range		DC 10.2 ~ 26.4V			
Max. load voltage		General output: 0.2A/ 1point, Output for positioning (P20, P21): 0.1A/ 1 point, 2A/1COM			
Off leakage current		0.1 mA or less			
Max. inrush current		4A / 10 ms or less			
Max. voltage drop (On)		DC 0.4V or less			
Surge absorber		Zener Diode			
Response time	Off → On	1 ms or less			
	On → Off	1 ms or less (Rated load, resistive load)			
Common method		16 point / COM			
Proper cable size		0.3 mm ²			
Current consumption		200 mA (when all point On)			
External power supply	Voltage	DC12/24V ± 10% (ripple voltage 4 Vp-p or less)			
	Current	10 mA or less (DC24V connection)			
Operation indicator		Output On, LED On			
External connection method		20 pin connector			
Weight		110g			
Circuit configuration					
			No.	Contact	
			B10	20	
			B09	21	
			B08	22	
			B07	23	
			B06	24	
			B05	25	
			B04	26	
			B03	27	
			B02	DC12 /24V	
			B01		
			A10	28	
			A09	29	
			A08	2A	
			A07	2B	
			A06	2C	
A05	2D				
A04	2E				
A03	2F				
A02	COM				
A01					

7.3.4 XBC-DR32H output unit

Model		Basic unit
Specification		XBC-DR32H(/DC)
Output point		16 point
Insulation method		Relay insulation
Rated load voltage/current		DC24V 2A (Resistive load) / AC220V 2A (COS Φ = 1), 5A/COM
Min. load voltage/current		DC5V / 1 mA
Max. load voltage		AC250V, DC125V
Off leakage current		0.1 mA (AC220V, 60 Hz)
Max. on/off frequency		3,600 times / hour
Surge killer		None
Life	Mechanical	20 million or above
	Electrical	Rated load voltage / current one hundred thousand or above
		AC200V / 1.5A, AC240V / 1A (COS Φ = 0.7) one hundred thousand or above
		AC200V / 1A, AC240V / 0.5A (COS Φ = 0.35) one hundred thousand or above
	DC24V / 1A, DC100V / 0.1A (L / R = 7 ms) one hundred thousand or above	
Response time	Off \rightarrow On	10 ms or less
	On \rightarrow Off	12 ms or less
Common method		4 point / COM
Proper cable size		Strand wire 0.3~0.75 mm ² (External diameter 2.8 mm or less)
Internal consumption current		360 mA (When all output are on)
Operation indicator		Output On, LED On
External connection method		24 point terminal block connector (M3 X 6 screw)
Weight		600g

Chapter 7. Input/Output Specifications

Circuit configuration	No.	contact	No.	Contact	Type
<p>Terminal block no.</p>	TB2	PE	TB1	AC100 ~ 240V	TB1
	TB4	NC	TB3		TB3
	TB6	21	TB5	20	TB5
	TB8	23	TB7	22	TB7
	TB10	24	TB9	COM0	TB9
	TB12	26	TB11	25	TB11
	TB14	COM1	TB13	27	TB13
	TB16	29	TB15	28	TB15
	TB18	2B	TB17	2A	TB17
	TB20	2C	TB19	COM2	TB19
	TB22	2E	TB21	2D	TB21
	TB24	COM3	TB23	2F	TB23

7.3.5 XBC-DR64H output unit

Model		Basic unit
Specification		XBC-DR64H(/DC)
Output point		32 point
Insulation method		Relay insulation
Rated load voltage/current		DC24V 2A (resistive load) / AC220V 2A (COS Φ = 1), 5A/COM
Min. load voltage/current		DC5V / 1 mA
Max. load voltage		AC250V, DC125V
Off leakage current		0.1 mA (AC220V, 60 Hz)
Max. on/off frequency		3,600 times / hour
Surge killer		None
Life	Mechanical	20 million or above
	Electrical	Rated load voltage / current one hundred thousand or above
		AC200V / 1.5A, AC240V / 1A (COS Φ = 0.7) one hundred thousand or above
		AC200V / 1A, AC240V / 0.5A (COS Φ = 0.35) one hundred thousand or above
		DC24V / 1A, DC100V / 0.1A (L / R = 7 ms) one hundred thousand or above
Response time	Off \rightarrow On	10 ms or less
	On \rightarrow Off	12 ms or less
Common method		4 point / COM (COM0~COM3), 8 point / COM (COM4~COM5)
Proper cable size		Strand wire 0.3~0.75 mm ² (External diameter 2.8 mm or less)
Internal consumption current		720 mA (When all output are on)
Operation indicator		Output On, LED On
External connection method		42 point terminal block connector (M3 X 6 screw)
Weight		900g

Chapter 7. Input/Output Specifications

Circuit configuration		No.	Contact	No.	Contact	type		
<p style="text-align: center;">INTERNAL CIRCUIT</p> <p style="text-align: center;">Terminal block no.</p>	TB5		TB1	AC100 ~240V	+	TB1		
	TB8	PE	TB3		PE	TB3		
	TB9	NC	TB5	20	NC	P20	TB5	
	TB10		TB7	22	P21	P22	TB7	
	TB13	21	TB9	COM0	P23	COM0	TB9	
	TB14	23	TB11	25	P24	P25	TB11	
	TB15	24	TB13	27	P26	P27	TB13	
	TB18	26	TB15	28	P28	P28	TB15	
	TB19	29	TB17	2A	COM1	P29	P2A	TB17
	TB20	2B	TB19	COM2	P2B	COM2	TB19	
	TB23	2C	TB21	2D	P2C	P2D	TB21	
	TB24	2E	TB23	2F	P2E	P2F	TB23	
	TB25	29	TB25	30	COM3	P30	TB25	
	TB32	31	TB27	32	P31	P32	TB27	
	TB33	33	TB29	34	P33	P34	TB29	
	TB34	35	TB31	36	P35	P36	TB31	
	TB41	37	TB33	COM4	P37	COM4	TB33	
	TB42	38	TB35	39	P38	P39	TB35	
		3A	TB37	3B	P3A	P3B	TB37	
		3C	TB39	3D	P3C	P3D	TB39	
		3E	TB41	3F	P3E	P3F	TB41	
		COM5			COM5	+	TB42	

7.3.6 XBC-DN32H output unit (Sink type)

Specification		Model	Basic unit
		XBC-DN32H/(DC)	
Output point		16 point	
Insulation method		Photo coupler insulation	
Rated load voltage/current		DC 12 / 24V	
Min. load voltage/current		DC 10.2 ~ 26.4V	
Max. load voltage		General output: 0.5A/ 1point, 2A/1COM Output for positioning (P20, P21, P22, P23): 0.1A/ 1 point, 0.4A/1COM	
Off leakage current		0.1 mA or less	
Max. on/off frequency		4A / 10 ms or less	
Surge killer		DC 0.4V or less	
Output point		Zener diode	
Response time	Off → On	1 ms or less	
	On → Off	1 ms or less (Rated load, resistive load)	
Common method		4 point / COM	
Proper cable size		Strand wire 0.3~0.75 mm ² (external diameter 2.8 mm or less)	
Internal consumption current		400 mA (When all output are on)	
External power supply	Voltage	DC12/24V ± 10% (ripple voltage 4 Vp-p or less)	
	Current	25 mA or less (When connecting DC24V)	
Operation indicator		Output On, LED On	
External connection method		24 point terminal block connector (M3 X 6 screw)	
Weight		500g	

Chapter 7. Input/Output Specifications

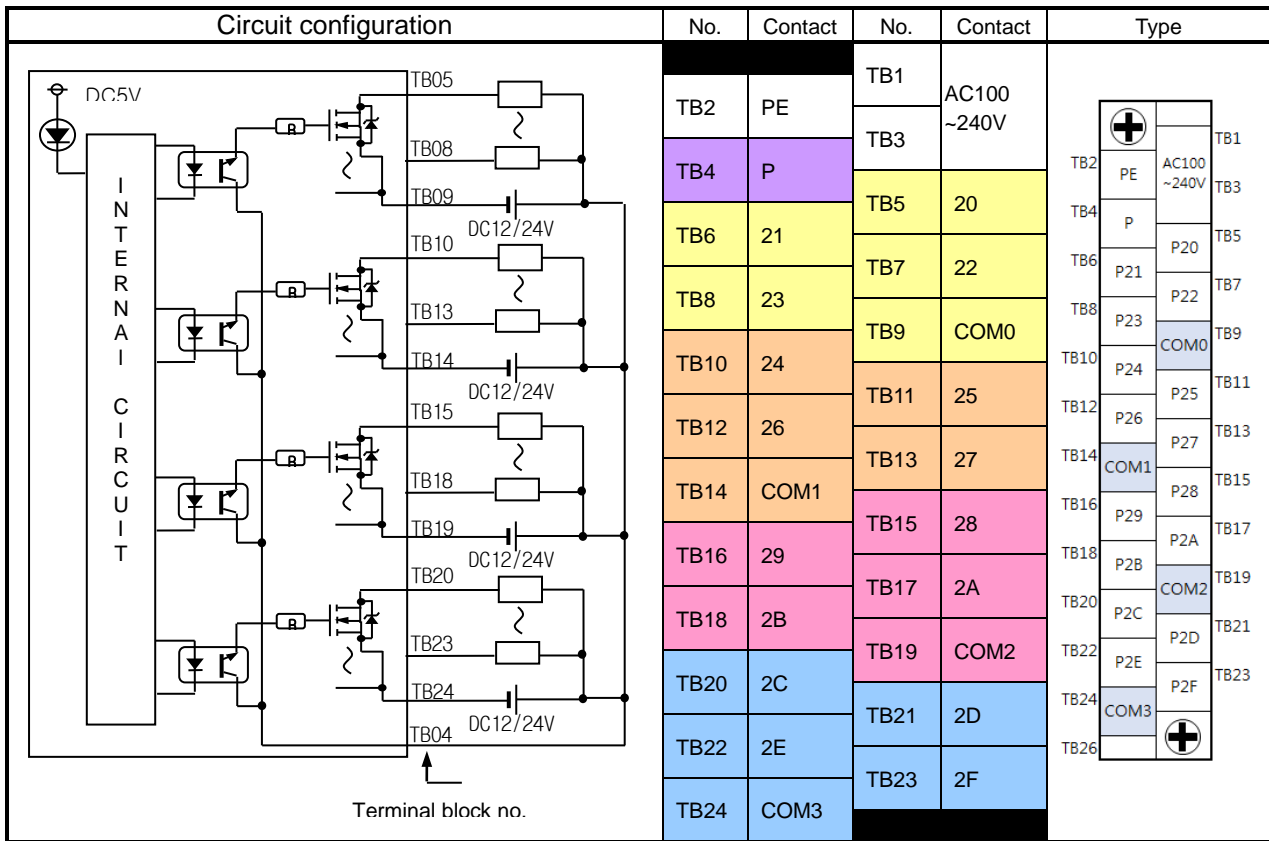

7.3.7 XBC-DN64H output unit (Sink type)

Model		Basic unit
Specification		XBC-DN64H(/DC)
Output point		32 point
Insulation method		Photo coupler insulation
Rated load voltage		DC 12 / 24V
Load voltage range		DC 10.2 ~ 26.4V
Max. load current		General output: 0.5A/ 1point, 2A/1COM Output for positioning (P20, P21, P22, P23): 0.1A/ 1 point, 0.4A/1COM
Off leakage current		0.1 mA or less
Max. inrush current		4A / 10 ms or less
On max. voltage drop		DC 0.4V or less
Surge killer		Zener diode
Response time	Off → On	1 ms or less
	On → Off	1 ms or less (Rated load, Resistive load)
Common method		4 point / COM (COM0~COM3), 8 point / COM (COM4~COM5)
Proper cable size		Strand wire 0.3~0.75 mm ² (external diameter 2.8 mm or less)
Internal consumption current		500 mA (When all output are on)
External power supply	Voltage	DC12/24V ± 10% (Ripple voltage 4 Vp-p or less)
	Current	25 mA or less (when connecting DC24V)
Operation indicator		Output On, LED On
External connection method		42 point terminal block connector (M3 X 6 screw)
Weight		800g

Chapter 7. Input/Output Specifications

Circuit configuration		No.	contact	No.	contact	Type	
	TB05			TB1	AC100 ~240V	TB1	
	TB08			TB3		TB3	
	TB09			TB5	20	TB5	
	TB10	DC12/24V	TB6	21	TB7	22	TB7
	TB13		TB8	23	TB9	COM0	TB9
	TB14		TB10	24	TB11	25	TB11
	TB15	DC12/24V	TB12	26	TB13	27	TB13
	TB18		TB14	COM1	TB15	28	TB15
	TB19		TB16	29	TB17	2A	TB17
	TB20	DC12/24V	TB18	2B	TB19	COM2	TB19
	TB23		TB20	2C	TB21	2D	TB21
	TB24		TB22	2E	TB23	2F	TB23
	TB25	DC12/24V	TB24	COM3	TB25	30	TB25
	TB32		TB26	31	TB27	32	TB27
	TB33		TB28	33	TB29	34	TB29
	TB34	DC12/24V	TB30	35	TB31	36	TB31
	TB41		TB32	37	TB33	COM4	TB33
	TB42		TB34	38	TB35	39	TB35
	TB04	DC12/24V	TB36	3A	TB37	3B	TB37
			TB38	3C	TB39	3D	TB39
			TB40	3E	TB41	3F	TB41
		TB42	COM5				

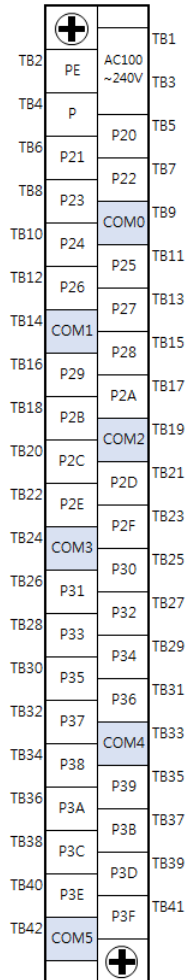

7.4 Digital Input Module Specification

7.4.1 8 point DC24V input module (Source/Sink type)

Model		DC input module		
Specification		XBE-DC08A		
Input point		8 point		
Insulation method		Photo coupler insulation		
Rated input voltage		DC24V		
Rated input current		About 4 mA		
Operation voltage range		DC20.4~28.8V (ripple rate < 5%)		
On Voltage/Current		DC19V or higher / 3 mA or higher		
Off Voltage/Current		DC6V or less / 1 mA or less		
Input resistance		About 5.6 kΩ		
Response time	Off → On	1/3/5/10/20/70/100 ms(set by CPU parameter) Default: 3 ms		
	On → Off			
Insulation pressure		AC560Vrms / 3Cycle (altitude 2000m)		
Insulation resistance		10 MΩ or more by Megohmmeter		
Common method		8 point / COM		
Proper cable size		Stranded pair 0.3~0.75 mm ² (External diameter 2.8 mm or less)		
Current consumption		30 mA (when all point On)		
Operation indicator		Input On, LED On		
External connection method		10 point terminal block connector		
Weight		52 g		
Circuit configuration		No.	Contact	Type
<p>Terminal block no.</p>		TB2	0	
		TB2	1	
		TB3	2	
		TB4	3	
		TB5	4	
		TB6	5	
		TB7	6	
		TB8	7	
		TB9	COM	
		TB10	COM	

7.4.2 16 point DC24V input module (Sink/Source type)

Model		DC input module	
		XBE-DC16A	XBE-DC16B
Specification		XBE-DC16A	XBE-DC16B
Input point		16 point	
Insulation method		Photo coupler insulation	
Rated input voltage		DC24V	DC12/24V
Rated input current		About 4 mA	About 4/8 mA
Operation voltage range		DC20.4~28.8V (ripple rate < 5%)	
On Voltage/Current		DC19V or higher / 3 mA or higher	DC9V or higher / 3 mA or higher
Off Voltage/Current		DC6V or less / 1 mA or less	DC5V or less / 1 mA or less
Input resistance		About 5.6 kΩ	About 2.7 kΩ
Response time	Off → On	1/3/5/10/20/70/100 ms (set by CPU parameter) Default: 3 ms	
	On → Off		
Insulation pressure		AC560Vrms / 3Cycle (altitude 2000m)	
Insulation resistance		10 MΩ or more by Megohmmeter	
Common method		16 point / COM	
Proper cable size		Stranded cable 0.3~0.75 mm ² (External diameter 2.8 mm or less)	
Current consumption		40 mA (when all point On)	
Operation indicator		Input On, LED On	
External connection method		8 pin terminal block connector + 10 pin terminal block connector	
Weight		53 g	
Circuit configuration		No.	Contact
		TB1	0
		TB2	1
		TB3	2
		TB4	3
		TB5	4
		TB6	5
		TB7	6
		TB8	7
		TB1	8
		TB2	9
		TB3	A
		TB4	B
		TB5	C
		TB6	D
		TB7	E
		TB8	F
TB9	COM		
TB10	COM		
		Type	
		TB1	
		TB2	
		TB3	
		TB4	
		TB5	
		TB6	
		TB7	
		TB8	
		TB1	
		TB2	
		TB3	
		TB4	
		TB5	
		TB6	
		TB7	
		TB8	
		TB9	
		TB10	

7.4.3 32 point DC24V input module (Source/Sink type)

Model		DC input module				
		XBE-DC32A				
Specification						
Input point		32 point				
Insulation method		Photo coupler insulation				
Rated input voltage		DC24V				
Rated input current		About 4 mA				
Operation voltage range		DC20.4~28.8V (ripple rate < 5%)				
Input Derating		Refer to Derating diagram				
On Voltage/Current		DC 19V or higher / 3 mA or higher				
Off Voltage/Current		DC 6V or less / 1 mA or less				
Input resistance		About 5.6 kΩ				
Response time	Off → On	1/3/5/10/20/70/100 ms (set by CPU parameter) Default:3 ms				
	On → Off					
Insulation pressure		AC 560Vrms / 3 Cycle (altitude 2000m)				
Insulation resistance		10 MΩ or more by Megohmmeter				
Common method		32 point / COM				
Proper cable size		0.3 mm ²				
Current consumption		50 mA (when all point On)				
Operation indicator		Input On, LED On				
External connection method		40 pin connector				
Weight		60g				
Circuit configuration		No.	Contact	No.	Contact	Type
		B20	00	A20	10	
		B19	01	A19	11	
<p>Input Derating diagram</p>		B18	02	A18	12	
		B17	03	A17	13	
		B16	04	A16	14	
		B15	05	A15	15	
		B14	06	A14	16	
		B13	07	A13	17	
		B12	08	A12	18	
		B11	09	A11	19	
		B10	0A	A10	1A	
		B09	0B	A09	1B	
		B08	0C	A08	1C	
		B07	0D	A07	1D	
		B06	0E	A06	1E	
		B05	0F	A05	1F	
		B04	NC	A04	NC	
		B03	NC	A03	NC	
		B02	COM	A02	COM	
		B01	COM	A01	COM	

7.4.4 8point AC110V input module

Model		AC input module
Specification		XBE-AC08A
Input point		8 point
Insulation method		Photo coupler insulation
Rated input voltage		AC100-120V(+10/-15%) 50/60 Hz(±3 Hz) (distortion rate < 5%)
Rated input current		About 8 mA(AC100,60 Hz), About 7mA(AC100, 50 Hz)
Inrush current		Max. 200 mA 1 ms (AC132V)
Input Derating		Refer to the below Derating diagram.
On Voltage/Current		AC80V or higher / 5 mA or higher (50 Hz, 60 Hz)
Off Voltage/Current		AC30V or lower / 1 mA or lower (50 Hz, 60 Hz)
Input resistance		About 12 kΩ(60 Hz), About 15 kΩ(50 Hz)
Response time	Off → On	20 ms or less (AC100V 50 Hz, 60 Hz)
	On → Off	25 ms or less (AC100V 50 Hz, 60 Hz)
Insulation pressure		AC3000Vrms / 3Cycle (altitude 2000m)
Insulation resistance		10 MΩ or more by Megohmmeter
Common method		4 point / COM
Proper cable size		Twisted pair 0.3~0.75 mm ² (external diameter 2.8mm or less)
Current consumption		30 mA (when all point On)
Operation indicator		Input On, LED On
External connection method		10 point terminal block connector
Weight		70 g

Circuit configuration	No.	Contact	Type
<p>AC110V * COM : TB5, TB10</p>	TB1	0	
	TB2	1	
	TB3	2	
	TB4	3	
	TB5	COM0	
	TB6	4	
	TB7	5	
	TB8	6	
	TB9	7	
	TB10	COM1	

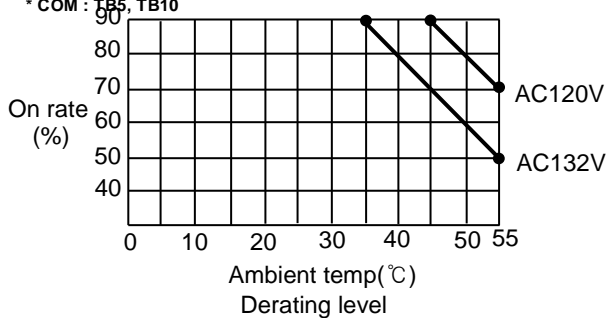

7.5 Digital Output Module Specification

7.5.1 8 point relay output module

Model		Relay output module		
Specification		XBE-RY08A		
Output point		8 point		
Insulation method		Relay insulation		
Rated load voltage / Current		DC24V 2A (Resistive load) / AC220V 2A (COSΨ = 1), 5A/COM		
Min. load voltage/Current		DC5V / 1 mA		
Max. load voltage/Current		AC250V, DC125V		
Off leakage current		0.1 mA (AC220V, 60 Hz)		
Max. On/Off frequency		3,600 times/hr		
Surge absorber		None		
Service life	Mechanical	20 millions times or more		
	Electrical	Rated load voltage / current 100,000 times or more		
		AC200V / 1.5A, AC240V / 1A (COSΨ = 0.7) 100,000 times or more		
		AC200V / 1A, AC240V / 0.5A (COSΨ = 0.35) 100,000 times or more		
		DC24V / 1A, DC100V / 0.1A (L / R = 7 ms) 100,000 times or more		
Response time	Off → On	10 ms or less		
	On → Off	12 ms or less		
Common method		8 point / COM		
Proper cable size		Stranded cable 0.3~0.75 mm ² (External diameter 2.8 mm or less)		
Current consumption		230 mA (when all point On)		
Operation indicator		Output On, LED On		
External connection method		9 pin terminal block connector		
Weight		80g		
Circuit configuration		No.	Contact	Type
<p>Terminal block no.</p>		TB1	0	
		TB2	1	
		TB3	2	
		TB4	3	
		TB5	4	
		TB6	5	
		TB7	6	
		TB8	7	
		TB9	COM	

7.5.2 8 point relay output module(Relay insulation)

Model		Relay output module
Specification		XBE-RY08B
Output point	8 point	
Insulation method	Relay insulation	
Rated load voltage / Current	DC24V 2A (Resistive load) / AC220V 2A (COSΨ = 1), 5A/COM	
Min. load voltage/Current	DC5V / 1 mA	
Max. load voltage/Current	AC250V, DC125V	
Off leakage current	0.1 mA (AC220V, 60 Hz)	
Max. On/Off frequency	3,600 times/hr	
Surge absorber	None	
Service life	Mechanical	20 millions times or more
	Electrical	Rated load voltage / current 100,000 times or more
		AC200V / 1.5A, AC240V / 1A (COSΨ = 0.7) 100,000 times or more
		AC200V / 1A, AC240V / 0.5A (COSΨ = 0.35) 100,000 times or more
	DC24V / 1A, DC100V / 0.1A (L / R = 7 ms) 100,000 times or more	
Response time	Off → On	10 ms or less
	On → Off	12 ms or less
Common method	8 point / COM	
Proper cable size	Stranded cable 0.3~0.75 mm ² (External diameter 2.8 mm or less)	
Current consumption	230 mA (when all point On)	
Operation indicator	Output On, LED On	
External connection method	9 pin terminal block connector	
Weight	81g	

Circuit configuration	No.	Contact	Type
	TB1	0	
	TB2	COM0	
	TB3	1	
	TB4	COM1	
	TB5	2	
	TB6	COM2	
	TB7	3	
	TB8	COM3	
	TB9	NC	
	TB1	4	
	TB2	COM4	
	TB3	5	
	TB4	COM5	
	TB5	6	
	TB6	COM6	
	TB7	7	
	TB8	COM7	
	TB9	NC	

7.5.3 16 point relay output module

Specification		Model	Relay output module					
			XBE-RY16A					
Output point		16 point						
Insulation method		Relay insulation						
Rated load voltage/ current		DC24V 2A (Resistive load) / AC220V 2A (COSΨ = 1), 5A/COM						
Min. load voltage/current		DC5V / 1 mA						
Max. load voltage/current		AC250V, DC125V						
Off leakage current		0.1 mA (AC220V, 60 Hz)						
Max. On/Off frequency		3,600 times/hr						
Surge absorber		None						
Service life	Mechanical	20 millions times or more						
	Electrical	Rated load voltage / current 100,000 times or more						
		AC200V / 1.5A, AC240V / 1A (COSΨ = 0.7) 100,000 times or more						
		AC200V / 1A, AC240V / 0.5A (COSΨ = 0.35) 100,000 times or more						
		DC24V / 1A, DC100V / 0.1A (L / R = 7 ms) 100,000 times or more						
Response time	Off → On	10 ms or less						
	On → Off	12 ms or less						
Common method		8 point / COM						
Proper cable size		Stranded cable 0.3~0.75 mm ² (External diameter 2.8 mm or less)						
Current consumption		420 mA (when all point On)						
Operation indicator		Output On, LED On						
External connection method		9 pin terminal block connector x 2 ea						
Weight		130g						
Circuit configuration					No.	Contact	Type	
					TB1	0	TB1	
					TB2	1	TB2	
					TB3	2	TB3	
					TB4	3	TB4	
					TB5	4	TB5	
					TB6	5	TB6	
					TB7	6	TB7	
					TB8	7	TB8	
					TB9	COM	TB9	
					TB1	8	TB1	
					TB2	9	TB2	
					TB3	A	TB3	
					TB4	B	TB4	
					TB5	C	TB5	
					TB6	D	TB6	
					TB7	E	TB7	
TB8	F	TB8						
TB9	COM	TB9						

7.5.4 8 point transistor output module (Sink type)

Model		Transistor output module		
		XBE-TN08A		
Specification				
Output point		8 point		
Insulation method		Photo coupler insulation		
Rated load voltage		DC 12 / 24V		
Load voltage range		DC 10.2 ~ 26.4V		
Max. load voltage		0.5A / 1 point		
Off leakage current		0.1 mA or less		
Max. inrush current		4A / 10 ms or less		
Max. voltage drop (On)		DC 0.4V or less		
Surge absorber		Zener Diode		
Response time	Off → On	1 ms or less		
	On → Off	1 ms or less (Rated load, resistive load)		
Common method		8 point / COM		
Proper cable size		Stranded cable 0.3~0.75 mm ² (External diameter 2.8 mm or less)		
Current consumption		40 mA (when all point On)		
External power supply	Voltage	DC12/24V ± 10% (ripple voltage 4 Vp-p or less)		
	Current	10 mA or less (DC24V connection)		
Operation indicator		Output On, LED On		
External connection method		10 pin terminal block connector		
Weight		52g		
Circuit configuration				
		No.	Contact	Type
		TB01	0	
		TB02	1	
		TB03	2	
		TB04	3	
		TB05	4	
		TB06	5	
		TB07	6	
		TB08	7	
		TB09	DC12 /24V	
TB10	COM			

7.5.5 16 point transistor output module (Sink type)

Model		Transistor output module		
Specification		XBE-TN16A		
Output point		16 point		
Insulation method		Photo coupler insulation		
Rated load voltage		DC 12 / 24V		
Load voltage range		DC 10.2 ~ 26.4V		
Max. load voltage		0.5A / 1 point, 2A / 1COM		
Off leakage current		0.1 mA or less		
Max. inrush current		4A / 10 ms or less		
Max. voltage drop (On)		DC 0.4V or less		
Surge absorber		Zener Diode		
Response time	Off → On	1 ms or less		
	On → Off	1 ms or less (Rated load, resistive load)		
Common method		16 point / COM		
Proper cable size		Stranded cable 0.3~0.75 mm ² (External diameter 2.8 mm or less)		
Current consumption		60 mA (when all point On)		
External power supply	Voltage	DC12/24V ± 10% (ripple voltage 4 Vp-p or less)		
	Current	10 mA or less (DC24V connection)		
Operation indicator		Output On, LED On		
External connection method		8 pin terminal block connector + 10 pin terminal block connector		
Weight		54 g		
Circuit configuration				
		No.	Contact	Type
		TB01	0	
		TB02	1	
		TB03	2	
		TB04	3	
		TB05	4	
		TB06	5	
		TB07	6	
		TB08	7	
		TB01	8	
		TB02	9	
		TB03	A	
		TB04	B	
		TB05	C	
		TB06	D	
		TB07	E	
TB08	F			
TB09	DC12 / 24V	TB09		
TB10	COM	TB10		

7.5.6 32 point transistor output module (Sink type)

Model		Transistor output module
Specification		XBE-TN32A
Output point	32 point	
Insulation method	Photo coupler insulation	
Rated load voltage	DC 12 / 24V	
Load voltage range	DC 10.2 ~ 26.4V	
Max. load voltage	0.2A / 1 point, 2A / 1COM	
Off leakage current	0.1 mA or less	
Max. inrush current	0.7A / 10 ms or less	
Max. voltage drop (On)	DC 0.4V or less	
Surge absorber	Zener Diode	
Response time	Off → On	1 ms or less
	On → Off	1 ms or less (Rated load, resistive load)
Common method	32 point / COM	
Proper cable size	0.3 mm ²	
Current consumption	120 mA (when all point On)	
External power supply	Voltage	DC12/24V ± 10% (ripple voltage 4 Vp-p or less)
	Current	20 mA or less (DC24V connection)
Operation indicator	Output On, LED On	
External connection method	40 pin connector	
Weight	60g	

Circuit configuration	No.	Conta ct	No.	Conta ct	Type
	B20	00	A20	10	
	B19	01	A19	11	
	B18	02	A18	12	
	B17	03	A17	13	
	B16	04	A16	14	
	B15	05	A15	15	
	B14	06	A14	16	
	B13	07	A13	17	
	B12	08	A12	18	
	B11	09	A11	19	
	B10	0A	A10	1A	
	B09	0B	A09	1B	
	B08	0C	A08	1C	
	B07	0D	A07	1D	
	B06	0E	A06	1E	
	B05	0F	A05	1F	
	B04	NC	A04	NC	
B03	NC	A03	NC		
B02	DC12/24V	A02	COM		
B01		A01			

7.5.7 8 point transistor output module (Source type)

Specification		Model	Transistor output module		
			XBE-TP08A		
Output point		8 point			
Insulation method		Photo coupler insulation			
Rated load voltage		DC 12 / 24V			
Load voltage range		DC 10.2 ~ 26.4V			
Max. load voltage		0.5A / 1 point			
Off leakage current		0.1 mA or less			
Max. inrush current		4A / 10 ms or less			
Max. voltage drop (On)		DC 0.4V or less			
Surge absorber		Zener Diode			
Response time	Off → On	1 ms or less			
	On → Off	1 ms or less (Rated load, resistive load)			
Common method		8 point / COM			
Proper cable size		Stranded cable 0.3~0.75 mm ² (external diameter 2.8 mm or less)			
Current consumption		40 mA (when all outputs are on)			
External power	Voltage	DC12/24V ± 10% (ripple voltage 4 Vp-p or less)			
	Current	10 mA or less (when connecting DC24V)			
Operation indicator		LED on when output on			
External connection method	10 pin terminal block connector				
Weight		30g			
Circuit configuration					
		No.	Contact		
		TB01	0		
		TB02	1		
		TB03	2		
		TB04	3		
		TB05	4		
		TB06	5		
		TB07	6		
		TB08	7		
		TB09	COM		
TB10	0V				

7.5.8 16 point transistor output module (Source type)

Model		Transistor output module				
		XBE-TP16A				
Specification						
Output point		16 point				
Insulation method		Photo coupler insulation				
Rated load voltage		DC 12 / 24V				
Load voltage range		DC 10.2 ~ 26.4V				
Max. load voltage		0.5A / 1 point, 2A / 1COM				
Off leakage current		0.1 mA or less				
Max. inrush current		4A / 10 ms or less				
Max. voltage drop (On)		DC 0.4V or less				
Surge absorber		Zener Diode				
Response time	Off → On	1 ms or less				
	On → Off	1 ms or less (Rated load, resistive load)				
Common method		16 point / COM				
Proper cable size		Stranded cable 0.3~0.75 mm ² (external diameter 2.8 mm or less)				
Current consumption		60 mA (When all outputs are on)				
External power	Voltage	DC12/24V ± 10% (ripple voltage 4 Vp-p or less)				
	Current	10 mA or less (connecting DC24V)				
Operation indicator		LED On when output On				
External connection method		8 pin terminal block connector + 10 pin terminal block connector				
Weight		40g				
Circuit configuration						
				No.	Contact	Type
				TB01	0	
				TB02	1	
				TB03	2	
				TB04	3	
				TB05	4	
				TB06	5	
				TB07	6	
				TB08	7	
				TB01	8	
				TB02	9	
				TB03	A	
				TB04	B	
				TB05	C	
				TB06	D	
				TB07	E	
TB08	F					
TB09	COM					
TB10	0V					

7.5.9 32 point transistor output module (Source type)

Model		Transistor output module							
Specification		XBE-TP32A							
Output point		32 point							
Insulation method		Photo coupler insulation							
Rated load voltage		DC 12 / 24V							
Load voltage range		DC 10.2 ~ 26.4V							
Max. load voltage		0.2A / 1 point, 2A / 1COM							
Off leakage current		0.1 mA or less							
Max. inrush current		4A / 10 ms or less							
Max. voltage drop (On)		DC 0.4V or less							
Surge absorber		Zener Diode							
Response time	Off → On	1 ms or less							
	On → Off	1 ms or less (Rated load, resistive load)							
Common method		32 point / COM							
Proper cable size		0.3 mm ²							
Current consumption		120 mA (When all outputs are on)							
External power	Voltage	DC12/24V ± 10% (ripple voltage 4 Vp-p or less)							
	Current	20 mA or less (connecting DC24V)							
Operation indicator		LED On when output On							
External connection method		40 pin connector							
Weight		60g							
Circuit configuration					No.	Contact	No.	Contact	Type
					B20	00	A20	10	
					B19	01	A19	11	
					B18	02	A18	12	
					B17	03	A17	13	
					B16	04	A16	14	
					B15	05	A15	15	
					B14	06	A14	16	
					B13	07	A13	17	
					B12	08	A12	18	
					B11	09	A11	19	
					B10	0A	A10	1A	
					B09	0B	A09	1B	
					B08	0C	A08	1C	
					B07	0D	A07	1D	
					B06	0E	A06	1E	
					B05	0F	A05	1F	
					B04	NC	A04	NC	
					B03	NC	A03	NC	
					B02	COM	A02	0V	
					B01	COM	A01	0V	

7.6 Digital I/O Mixed module Input Specification

7.6.1 8 point DC24V input (Source/Sink type)

Model		DC input module		
Specification		XBE-DR16A		
Input point		8 point		
Insulation method		Photo coupler insulation		
Rated input voltage		DC24V		
Rated input current		About 4 mA		
Operation voltage range		DC20.4~28.8V (within ripple rate 5%)		
On Voltage/Current		DC19V or higher / 3 mA or higher		
Off Voltage/Current		DC6V or less / 1 mA or less		
Input resistance		About 5.6 kΩ		
Response time	Off → On	1/3/5/10/20/70/100 ms(set by CPU parameter) Default: 3 ms		
	On → Off			
Insulation pressure		AC560Vrms / 3Cycle (altitude 2000m)		
Insulation resistance		10 MΩ or more by Megohmmeter		
Common method		8 point / COM		
Proper cable size		Stranded cable 0.3~0.75 mm ² (External diameter 2.8 mm or less)		
Current consumption		280 mA (When all inputs and outputs are on)		
Operation indicator		LED on when input on		
External connection method		9 pin terminal block connector		
Weight		81g		
Circuit configuration				
		No.	Contact	Type
		TB1	0	
		TB2	1	
		TB3	2	
		TB4	3	
		TB5	4	
		TB6	5	
		TB7	6	
		TB8	7	
		TB9	COM	

7.6.2 16 point DC24V input (Source/Sink type)

Model Specification		DC input module							
		XBE-DN32A							
Input point		16 point							
Insulation method		Photo coupler insulation							
Rated input voltage		DC24V							
Rated input current		About 4 mA							
Operation voltage range		DC20.4~28.8V (ripple rate < 5%)							
Input Derating		Refer to Derating diagram							
On Voltage/Current		DC 19V or higher / 3 mA or higher							
Off Voltage/Current		DC 6V or less / 1 mA or less							
Input resistance		About 5.6 kΩ							
Response time	Off → On	1/3/5/10/20/70/100 ms (set by CPU parameter) Default:3 ms							
	On → Off								
Insulation pressure		AC 560Vrms / 3 Cycle (altitude 2000m)							
Insulation resistance		10 MΩ or more by Megohmmeter							
Common method		16 point / COM							
Proper cable size		0.3 mm ²							
Current consumption		60 mA (When all inputs and outputs are on)							
Operation indicator		Input On, LED On							
External connection method		40 pin connector							
Weight		60g							
Circuit configuration					No.	Contact	No.	Contact	Type
					B20	00	A20	20	
					B19	01	A19	21	
B18	02	A18	22						
B17	03	A17	23						
B16	04	A16	24						
B15	05	A15	25						
B14	06	A14	26						
B13	07	A13	27						
B12	08	A12	28						
B11	09	A11	29						
B10	0A	A10	2A						
B09	0B	A09	2B						
B08	0C	A08	2C						
B07	0D	A07	2D						
B06	0E	A06	2E						
B05	0F	A05	2F						
B04	NC	A04	P						
B03	NC	A03	P						
B02	IN_COM	A02	OUT_COM						
B01	IN_COM	A01	OUT_COM						

7.7 Digital I/O Mixed module Output Specification

7.7.1 8 point relay output

Model		Relay output module		
Specification		XBE-DR16A		
Output point		8 point		
Insulation method		Relay insulation		
Rated load voltage / Current		DC24V 2A(Resistive load) / AC220V 2A(COSΨ = 1), 5A/COM		
Min. load voltage/Current		DC5V / 1 mA		
Max. load voltage		AC250V, DC125V		
Off leakage current		0.1 mA (AC220V, 60 Hz)		
Max. On/Off frequency		3,600 times/hr		
Surge absorber		None		
Service life	Mechanical	20 millions times or more		
	Electrical	Rated load voltage / current 100,000 times or more		
		AC200V / 1.5A, AC240V / 1A (COSΨ = 0.7) 100,000 times or more		
		AC200V / 1A, AC240V / 0.5A (COSΨ = 0.35) 100,000 times or more		
		DC24V / 1A, DC100V / 0.1A (L / R = 7 ms) 100,000 times or more		
Response time	Off → On	10 ms or less		
	On → Off	12 ms or less		
Common method		8 point / COM		
Proper cable size		Stranded cable 0.3~0.75 mm ² (external diameter 2.8 mm or less)		
Current consumption		280 mA (When all inputs and outputs are on)		
Operation indicator		LED on when output on		
External connection method		9 pin terminal block connector		
Weight		81g		
Circuit configuration				
		No.	Contact	Type
		TB1	0	
		TB2	1	
		TB3	2	
		TB4	3	
		TB5	4	
		TB6	5	
		TB7	6	
		TB8	7	
		TB9	COM	

7.7.2 16 point transistor output (Sink type)

Model		Transistor output module			
Specification		XBE-DN32A			
Output point		16 point			
Insulation method		Photo coupler insulation			
Rated load voltage		DC 12 / 24V			
Load voltage range		DC 10.2 ~ 26.4V			
Max. load voltage		0.2A / 1 point, 2A / 1COM			
Off leakage current		0.1 mA or less			
Max. inrush current		0.7A / 10 ms or less			
Max. voltage drop (On)		DC 0.4V or less			
Surge absorber		TVS Diode			
Response time	Off → On	1 ms or less			
	On → Off	1 ms or less (Rated load, resistive load)			
Common method		16 point / COM			
Proper cable size		0.3 mm ²			
Current consumption		60 mA (When all inputs and outputs are on)			
External power supply	Voltage	DC12/24V ± 10% (ripple voltage 4 Vp-p or less)			
	Current	20 mA or less (DC24V connection)			
Operation indicator		Output On, LED On			
External connection method		40 pin connector			
Weight		60g			
Circuit configuration					
No.	Contact	No.	Contact	Type	
B20	00	A20	20		
B19	01	A19	21		
B18	02	A18	22		
B17	03	A17	23		
B16	04	A16	24		
B15	05	A15	25		
B14	06	A14	26		
B13	07	A13	27		
B12	08	A12	28		
B11	09	A11	29		
B10	0A	A10	2A		
B09	0B	A09	2B		
B08	0C	A08	2C		
B07	0D	A07	2D		
B06	0E	A06	2E		
B05	0F	A05	2F		
B04	NC	A04	P		
B03	NC	A03	P		
B02	IN_COM	A02	OUT_COM		
B01	IN_COM	A01	OUT_COM		

7.8 IO Wiring by Using Smart Link Board

7.8.1 Smart link board

Easy wiring is available by connecting the IO connector with smart link board.
The available smart link and IO cable are as follows.

XGB		Smart link		Connection cable		
Item	Model	Model	No. of Pin	Model	Length	Contents
Main unit	XBM-DN32S	XTB-40H	40	R40H/20HH-05S-XBM3	0.5m~1m	For main unit connection (20Pin + 20Pin)
	XBM-DN16S			R40H/20HH-10S-XBM3		
Expansion module	XBE-DC32A	XTB-40H	40	C40HH-05SB-XBE C40HH-10SB-XBE C40HH-15SB-XBE C40HH-20SB-XBE C40HH-30SB-XBE	0.5m~3m	For expansion module connection (40Pin)
	XBE-TN32A	XTB-40H	40			For expansion module connection (40Pin)
		R32C-NS5A-40P	40			Exclusive for relay built-in SLP type

It describes wiring of XGB, XTB-40H and R40H/20HH-10S-XBM3.
For wiring of other smart link boards or XGB extension module, refer to XGB user manual for hardware.

1) XTB-40H terminal array

Terminal array of XTB-40H is as follows.

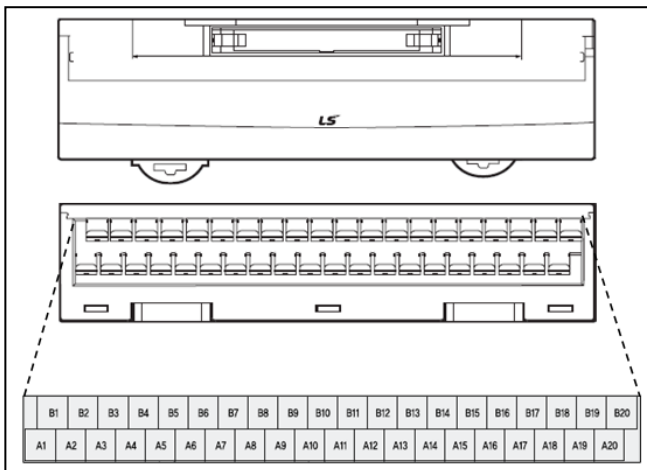

Item	Specification	
Rated voltage	AC125 / DC 24[V]	
Rated current	Max. 1[A]	
Withstanding voltage	500V 1min	
Insulation resistor	100 MΩ (DC500V)	
Cable specification	AWG22-16 (1.5mm ² / MAX)	
Terminal/screw	M3 X 8L	
Torque	1.2N · m (12kgf · cm)	
material	Terminal	Modifide PP0
	Cover	Polycarbonate
	PCB	Epoxy 1.6t

2) Wiring of XTB-40H and XGB main unit

Wiring of XGB main unit through XTB-40H and R40H/20HH-10S-XBM3 is as follows.



At this time, relationship of XGB IO signal and Smart link board terminal number is as follows.

The following figure describes signal allocation when R40H/20HH-05S-XBM3 is used as connection cable. When the user makes the cable, make sure that wiring is done as figure below.

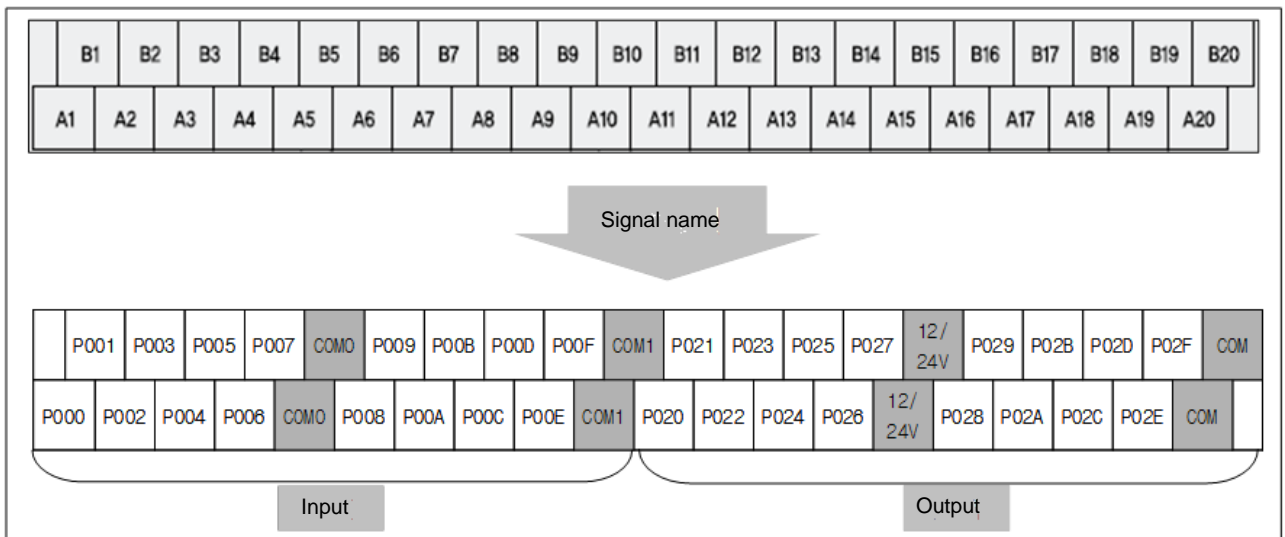

Chapter 7. Input/Output Specifications

3) Wiring of XTB-40H and XGB extension module

Wiring of XGB extension module through XTB-40H and C40HH-10SB-XBE SLT-CT101-XBE is as follows.

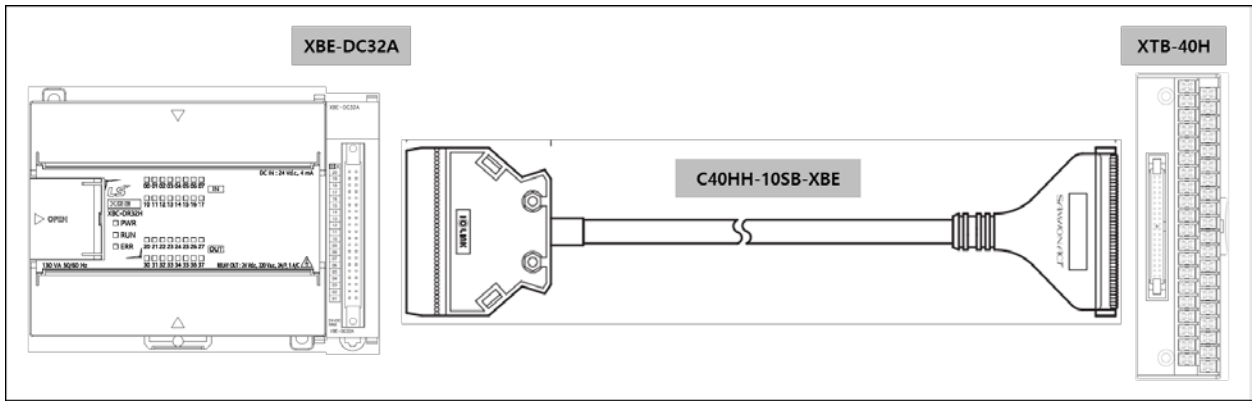

At this time, relationship of XGB IO signal and Smart link board terminal number is as follows. The following figure describes signal allocation when C40HH-10SB -XBE is used as connection cable. When the user makes the cable, make sure that wiring is done as figure below.

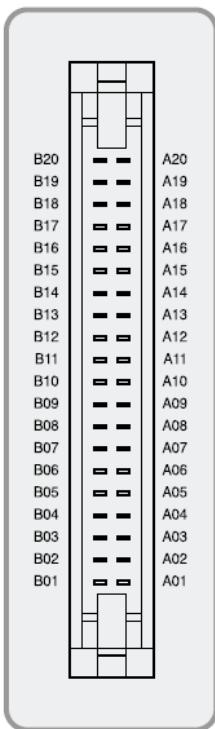

Pin No.		PLC						Terminal block Name	
		XBE-DC32A		XBE-TN32A		XBE-TP32A		Terminal block board (SLP-T40P)	
B20	A20	00	10	00	10	00	10	A1	A11
B19	A19	01	11	01	11	01	11	B1	B11
B18	A18	02	12	02	12	02	12	A2	A12
B17	A17	03	13	03	13	03	13	B2	B12
B16	A16	04	14	04	14	04	14	A3	A13
B15	A15	05	15	05	15	05	15	B3	B13
B14	A14	06	16	06	16	06	16	A4	A14
B13	A13	07	17	07	17	07	17	B4	B14
B12	A12	08	18	08	18	08	18	A5	A15
B11	A11	09	19	09	19	09	19	B5	B15
B10	A10	0A	1A	0A	1A	0A	1A	A6	A16
B09	A09	0B	1B	0B	1B	0B	1B	B6	B16
B08	A08	0C	1C	0C	1C	0C	1C	A7	A17
B07	A07	0D	1D	0D	1D	0D	1D	B7	B17
B06	A06	0E	1E	0E	1E	0E	1E	A8	A18
B05	A05	0F	1F	0F	1F	0F	1F	B8	B18
B04	A04	NC	NC	NC	NC	NC	NC	A9	A19
B03	A03	NC	NC	NC	NC	NC	NC	B9	B19
B02	A02	COM	COM	DC12/24V	COM	COM	DC0V	A10	A20
B01	A01							B10	B20

4) I/O wiring
 - XBE-DC32A (XTB-40H)

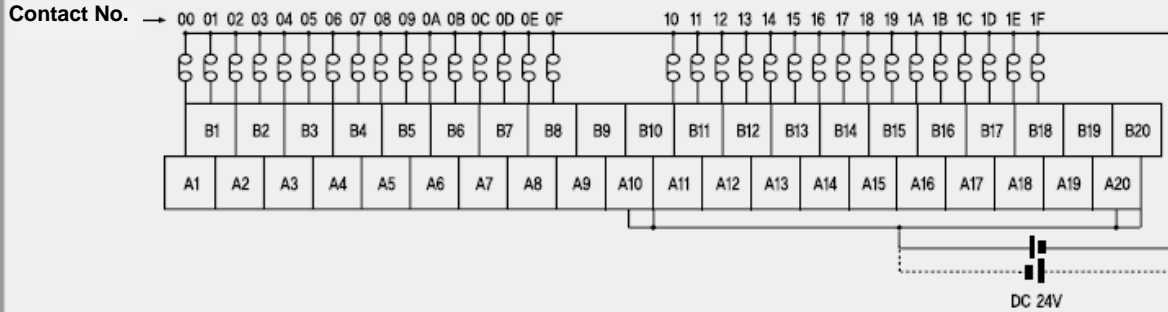

- XBE-TN32A (XTB-40H)

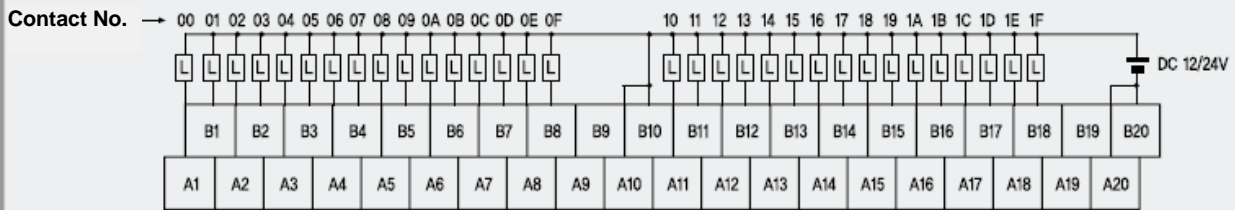

- XBE-TP32A (XTB-40H)

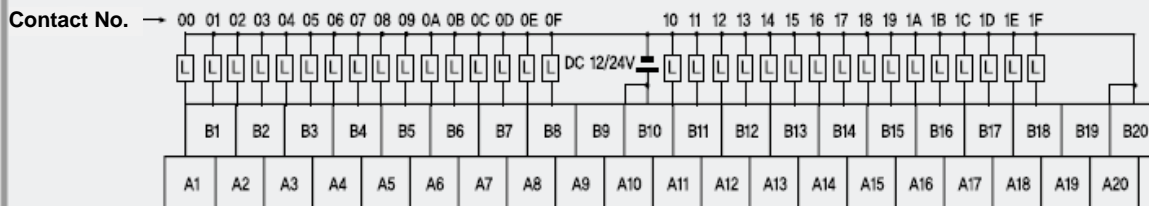

- XBE-TN32A (R32C-NS5A-40P)

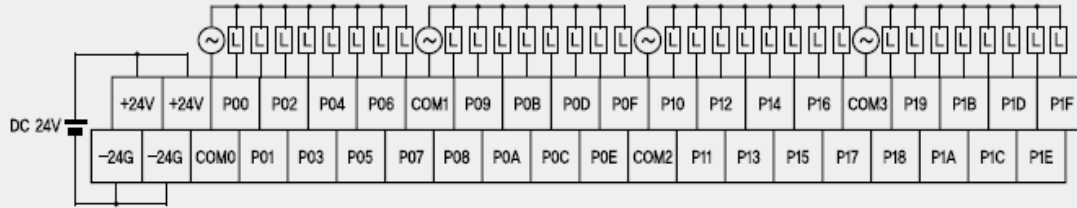

Chapter 8 Built-in High-speed Counter Function

XGB series have built-in function of High-speed counter in basic unit. This chapter describes specifications and usage of High-speed counter's function.

8.1 High-speed Counter Specifications

- It describes specifications, setting and usage of function, programming and wiring with external device of built-in basic unit.

8.1.1 Performance specifications

(1) Performance specification

Classification		Description	
		"S" type	"H" type
Count input signal	Signal	A-phase, B-phase	
	Input type	Voltage input (Open collector)	
	Signal level	24V	
Max. coefficient speed		20 kpps	100 kpps
Number of channels	1 phase	4 (20kpps 4 channels)	8 (10kpps 4 channels/20kpps 4 channels)
	2 phase	2	4 (50kpps 2 channels/ 10kpps 2 channels)
		4	
Coefficient range		Signed 32 Bit (-2,147,483,648 ~ 2,147,483,647)	
Count mode (Program setting)		Linear count (if 32-bit range exceeded, Carry/Borrow occurs) Counter max. and min. value is indicated Ring count (repeated count within setting range)	
Input mode (Program setting)		1-phase input 2-phase input CW/CCW input	
Signal type		Voltage	
Up/Down setting	1 phase input	Increasing/decreasing operation setting by B-phase input	
		Increasing/decreasing operation setting by program	
	CW/CCW	A-phase input: increasing operation B-phase input: decreasing operation	
Multiplication function	1 phase input	1 multiplication	
	2 phase input	4 multiplication	
	CW/CCW	1 multiplication	
Control input	Signal	Preset instruction input	
	Signal level	DC 24V input type	
	Signal type	Voltage	
External output	Output points	1 point/channel (for each channel) :output contact point of basic unit available	2 point/channel (for each channel) :output contact point of basic unit available
	Type	Select single-compared (>, >=, =, <=, <) or section compared output (included or excluded) (program setting)	

Classification	Description	
	"S" type	"H" type
Output type	Relay, Open-collector output (Sink)	
Count Enable	To be set through program (count available only in enable status)	
Preset function	To be set through terminal (contact) or program	
Auxiliary mode	Count Latch	

(2) Counter/Preset input specification

Classification	Spcification
Input voltage	24V DC (20.4V ~ 28.8V)
Input current	4mA
On guranteed voltage (min.)	20.4V
Off guranteed voltage (max.)	6V

8.1.2 Designation of parts

(1) Designation of parts

Name	“S” type		“H” type
	XBM-DN16/32S	XBM-DR16S	XBC-DN32/64H, XBC-DR32.64H
Structure			

(a) “S” type

Terminal No.	Names		Usage	
	1-phase	2-phase	1-phase	2-phase
P000	Ch0 counter input	Ch0 A-phase input	Counter input terminal	A-phase input
P001	Ch1 counter input	Ch0 B-phase input	Counter input terminal	B-phase input
P002	Ch2 counter input	Ch2 A-phase input	Counter input terminal	A-phase input
P003	Ch3 counter input	Ch2 B-phase input	Counter input terminal	B-phase input
P004	Ch0 preset 24V	Ch0 preset 24V	Preset input terminal	Preset input terminal
P005	Ch1 preset 24V	-	Preset input terminal	No use
P006	Ch2 preset 24V	Ch2 preset 24V	Preset input terminal	Preset input terminal
P007	Ch3 preset 24V	-	Preset input terminal	No use
COM0	Input common	Input common	Common terminal	Common terminal

(b) “H” type

Terminal No.	Names		Usage	
	1-phase	2-phase	1-phase	2-phase
P000	Ch0 counter input	Ch0 A-phase input	Counter input terminal	A-phase input
P001	Ch1 counter input	Ch0 B-phase input	Counter input terminal	B-phase input
P002	Ch2 counter input	Ch2 A-phase input	Counter input terminal	A-phase input
P003	Ch3 counter input	Ch2 B-phase input	Counter input terminal	B-phase input
P004	Ch4 counter input	Ch4 A-phase input	Counter input terminal	A-phase input
P005	Ch5 counter input	Ch4 B-phase input	Counter input terminal	B-phase input
P006	Ch6 counter input	Ch6 A-phase input	Counter input terminal	A-phase input
P007	Ch7 counter input	Ch6 B-phase input	Counter input terminal	B-phase input

P008	Ch0 preset 24V	Ch0 preset 24V	Preset input terminal	Preset input terminal
P009	Ch1 preset 24V	-	Preset input terminal	No use
P00A	Ch2 preset 24V	Ch2 preset 24V	Preset input terminal	Preset input terminal
P00B	Ch4 preset 24V	-	Preset input terminal	No use
P00C	Ch5 preset 24V	Ch4 preset 24V	Preset input terminal	Preset input terminal
P00D	Ch6 preset 24V	-	Preset input terminal	No use
P00E	Ch7 preset 24V	Ch6 preset 24V	Preset input terminal	Preset input terminal
P00F	Ch8 preset 24V	-	Preset input terminal	No use
COM0	Input common	Input common	Input common	Input common

(3) Interface with external devices

The internal circuit of High-speed counter is as shown below.

(a) "S" type

I/O	Internal circuit	Terminal No.	Signal		Operation	On/Off guaranteed voltage
			1-phase	2-phase		
Input		P00	Ch 0 Pulse input	Ch 0 A-phase input	On	20.4~28.8V
					Off	6V or less
		P01	Ch 1 Pulse input	Ch 0 B-phase input	On	20.4~28.8V
					Off	6V or less
		P02	Ch 2 Pulse input	Ch 2 A-phase input	On	20.4~28.8V
					Off	6V or less
		P03	Ch 3 Pulse input	Ch 2 B-phase input	On	20.4~28.8V
					Off	6V or less
		P04	Ch 0 Preset input	Ch 0 Preset input	On	20.4~28.8V
					Off	6V or less
P05	Ch 1 Preset input	-	On	20.4~28.8V		
			Off	6V or less		
P06	Ch 2 Preset input	Ch 2 Preset input	On	20.4~28.8V		
			Off	6V or less		
P07	Ch 2 Preset input	-	On	20.4~28.8V		
			Off	6V or less		
		COM0	COM (input common)			

I/O	Internal circuit	Terminal No.	Signal		Operation	On/Off guaranteed voltage	
			1-phase	2-phase			
Input		P0000	Ch 0 Pulse input	Ch 0 A-phase input	On	20.4-28.8V	
		P0001	Ch 1 Pulse input	Ch 0 B-phase input	Off	6V or less	
		P0002	Ch 2 Pulse input	Ch 2 A-phase input	On	20.4-28.8V	
		P0003	Ch 3 Pulse input	Ch 2 B-phase input	Off	6V or less	
		P0004	Ch 4 Pulse input	Ch 4 A-phase input	On	20.4-28.8V	
		P0005	Ch 5 Pulse input	Ch 4 B-phase input	Off	6V or less	
		P0006	Ch 6 Pulse input	Ch 6 A-phase input	On	20.4-28.8V	
		P0007	Ch 7 Pulse input	Ch 6 B-phase input	Off	6V or less	
		P0008	Ch 0 Preset input	Ch 0 Preset input	On	20.4-28.8V	
		P0009	Ch 1 Preset input	-	Off	6V or less	
		P000A	Ch 2 Preset input	Ch 2 Preset input	On	20.4-28.8V	
		P000B	Ch 3 Preset input	-	Off	6V or less	
		P000C	Ch 4 Preset input	Ch 4 Preset input	On	20.4-28.8V	
		P000D	Ch 5 Preset input	-	Off	6V or less	
		P000E	Ch 6 Preset input	Ch 6 Preset input	On	20.4-28.8V	
		P000F	Ch 7 Preset input	-	Off	6V or less	
		COM0	COM (input common)				

8.1.3 “S” type Functions

(1) Counter mode

A) High Speed counter module can count High Speed pulses which can not be processed by CPU module’s counter instructions (CTU, CTD, CTUD, etc.), up to binary value of 32 bits (-2,147,483,648 ~ 2,147,483,647).

B) Available input is 1-phase input, 2-phase input and CW/ CCW input.

C) Count increasing/decreasing methods are as follows;

- (1) For 1-phase input: (1) Increasing/decreasing count operation by program setting
 (2) Increasing/decreasing count operation by B-phase input signal
- (2) For 2-phase input: setting by difference in phase between A-phase and B-phase
- (3) For CW/CCW input: Increasing operation if B-phase is LOW with A-phase input, and Decreasing operation if A-phase is LOW with B-phase input.

D) Auxiliary modes are as follows;

- ① Count Latch
- ② Periodic Pulse Count

E) Pulse input mode

(1) Increasing/decreasing count operation by program setting

a) 1-phase 1-input 1-multiplication operation mode

A-phase input pulse counts at rising and increasing/decreasing will be decided by the applicable program.

Increasing/Decreasing classification	A-phase input pulse rising	A-phase input pulse falling
Increasing/decreasing count setting signal Off	Increasing count	-
Increasing/decreasing count setting signal On	Decreasing count	-

• Operation example

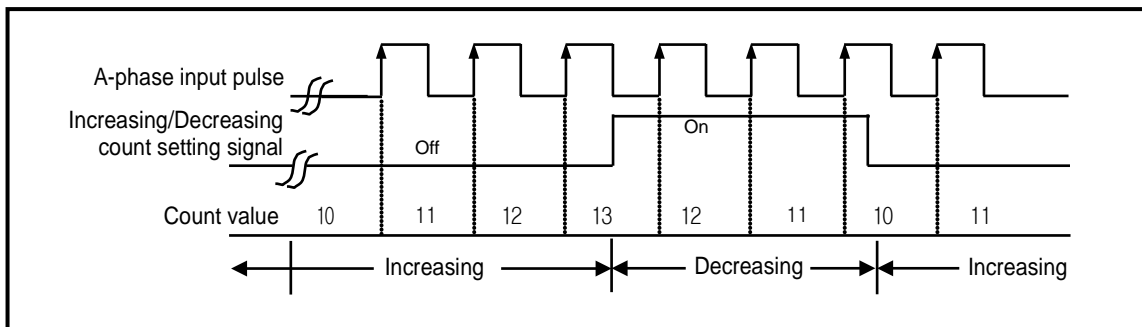

(2) Increasing/decreasing count operation by B-phase input signal

a) 1-phase 2-input 1-multiplication operation mode

A-phase input pulse counts at rising and increasing/decreasing will be decided by B-phase.

Increasing/Decreasing classification	A-phase input pulse rising	A-phase input pulse falling
B-phase input pulse Off	Increasing count	-
B-phase input pulse On	Decreasing count	-

• Operation example

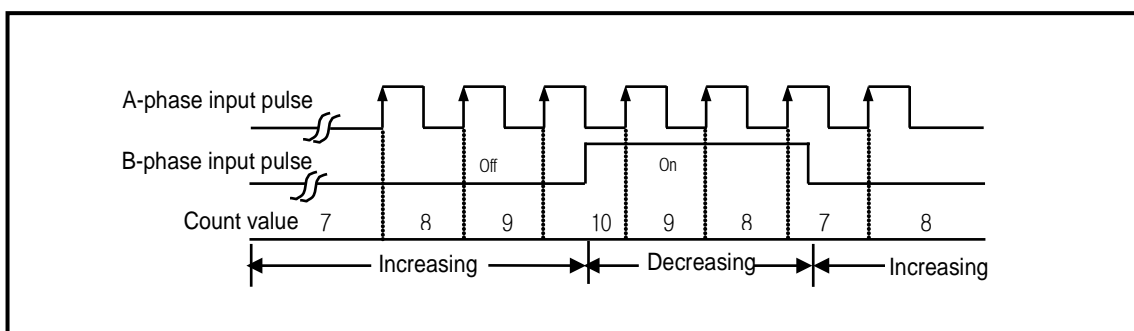

2) 2-phase count mode

a) 2-phase 4-multiplication operation mode

A-phase input pulse and B-phase input pulse count at rising/falling respectively. If A-phase input is antecedent to B-phase input, increasing operation starts, and if B-phase input is antecedent to A-phase input, decreasing operation starts.

▪ Operation example

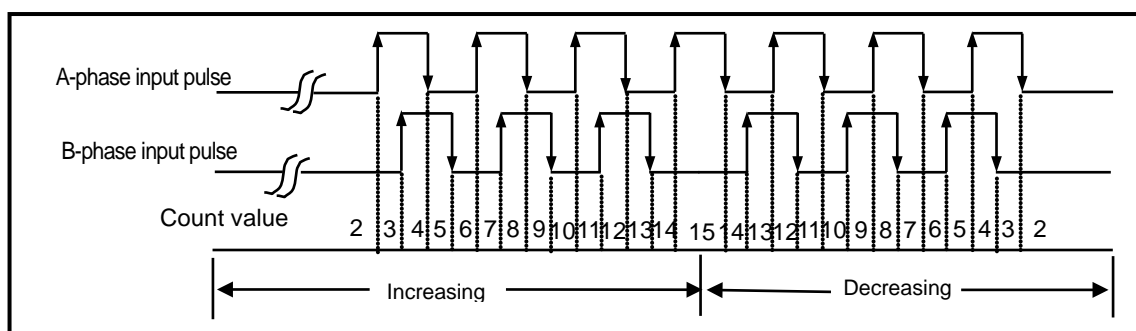

3) CW(Clockwise)/CCW(Counter Clockwise) operation mode

A-phase input pulse counts at rising , or B-phase input pulse counts at rising.

Increasing operation executed when B-phase input pulse is Low with A-phase input pulse at rising, and Decreasing operation executed when A-phase input pulse is Low with B-phase input pulse at rising.

Increasing/Decreasing classification	A-phase input pulse High	A-phase input pulse Low
B-phase input pulse High	-	decreasing count
B-phase input pulse Low	Increasing count	-

▪ Operation example

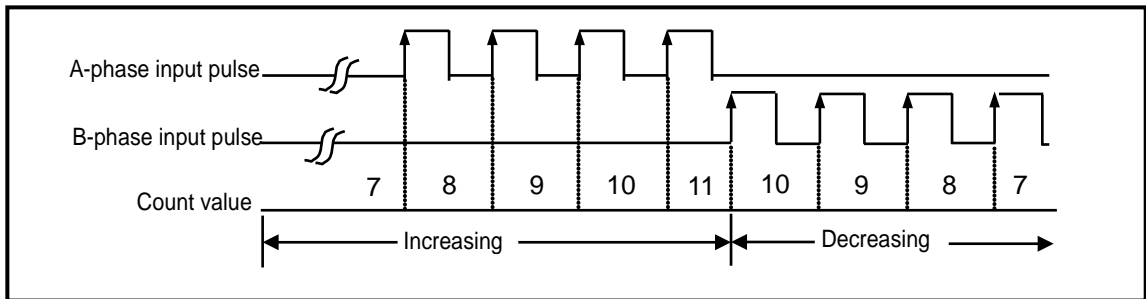

(4) Counter type

2 types of count (Linear counter, Ring counter) can be selected for the applicable use based on functions.

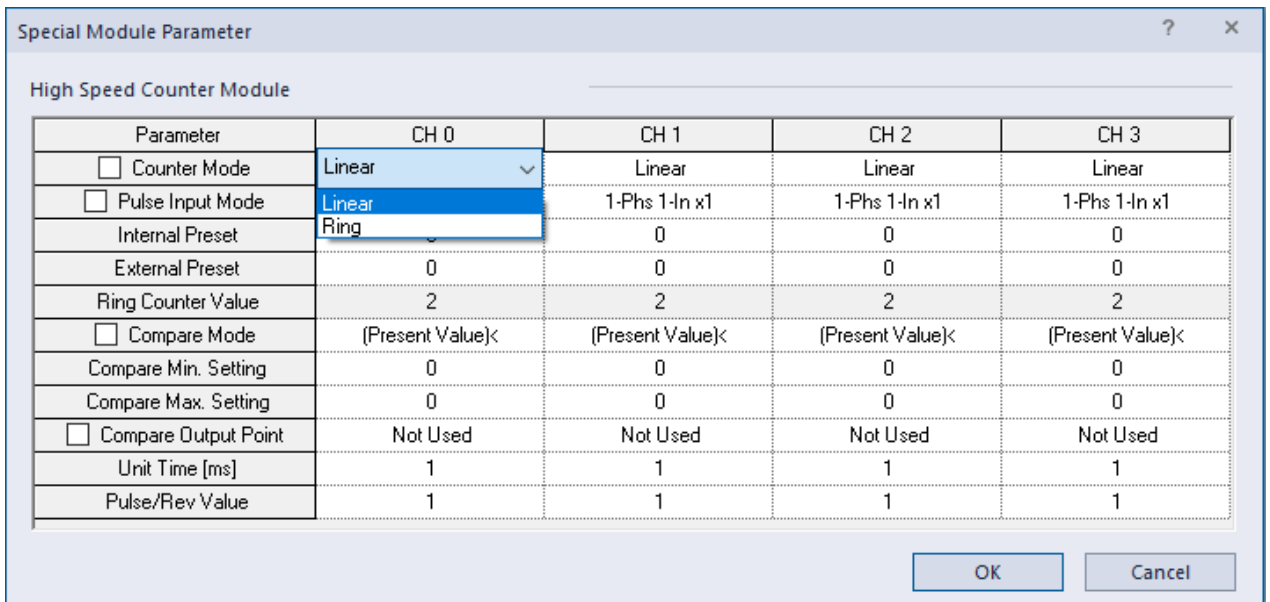

▪ Counter mode is saved at the following special K area.

Mode	Area per each channel (word)				Reference*1)
	Ch.0	Ch.1	Ch.2	Ch.3	
Counter mode	K300	K330	K360	K390	0 : linear 1 : ring

*1) If counter mode is set as value other than 0, 1, error code '20' will occur.

2 types of count can be selected for the applicable use based on functions.

A) Linear counter

- Linear Count range: -2,147,483,648 ~ 2,147,483,647
- If count value reaches the maximum value while increased, Carry will occur, and if count value reaches the minimum value while decreased, Borrow will occur.
- If Carry occurs, count stops and increasing is not available but decreasing is available.
- If Borrow occurs, count stops and decreasing is not available but increasing is available.

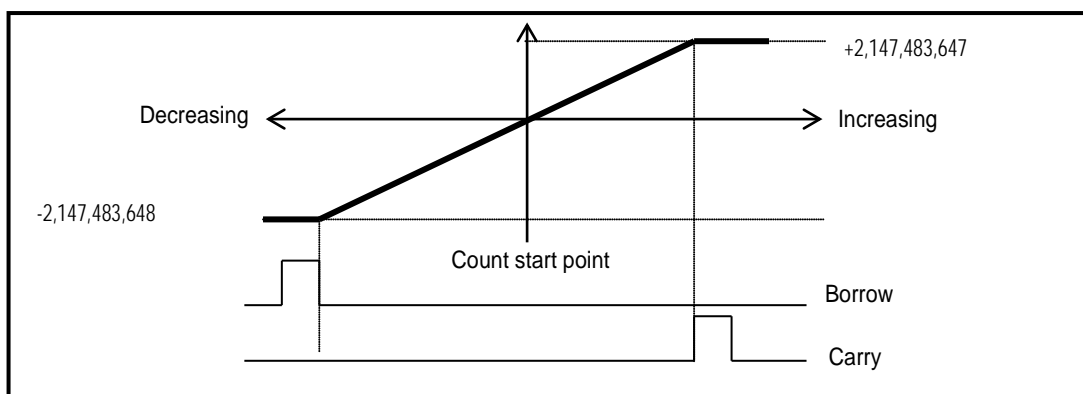

B) Ring count

- Ring Count range: user-defined minimum value ~ user-defined maximum value
- Count display: If Ring Counted, user-defined minimum value of Ring Count is counted and displayed, but the value is not displayed.

Special Module Parameter

High Speed Counter Module

Parameter	CH 0	CH 1	CH 2	CH 3
<input type="checkbox"/> Counter Mode	Ring	Linear	Linear	Linear
<input type="checkbox"/> Pulse Input Mode	1-Phs 1-In x1	1-Phs 1-In x1	1-Phs 1-In x1	1-Phs 1-In x1
Internal Preset	0	0	0	0
External Preset	0	0	0	0
Ring Counter Value	1000	2	2	2
<input type="checkbox"/> Compare Mode	(Present Value)<	(Present Value)<	(Present Value)<	(Present Value)<
Compare Min. Setting	0	0	0	0
Compare Max. Setting	0	0	0	0
<input type="checkbox"/> Compare Output Point	Not Used	Not Used	Not Used	Not Used
Unit Time [ms]	1	1	1	1
Pulse/Rev Value	1	1	1	1

2~2147483647

OK Cancel

- Ring counter value is saved at the following special K area.

type	Area per each channel (Double word)				Reference
	Ch.0	Ch.1	Ch.2	Ch.3	
Ring counter value	K310	K340	K270	K400	

1) During increasing count

- Even if count value exceeds user-defined maximum value during increasing count, Carry only occurs and count does not stop differently to Linear Count.

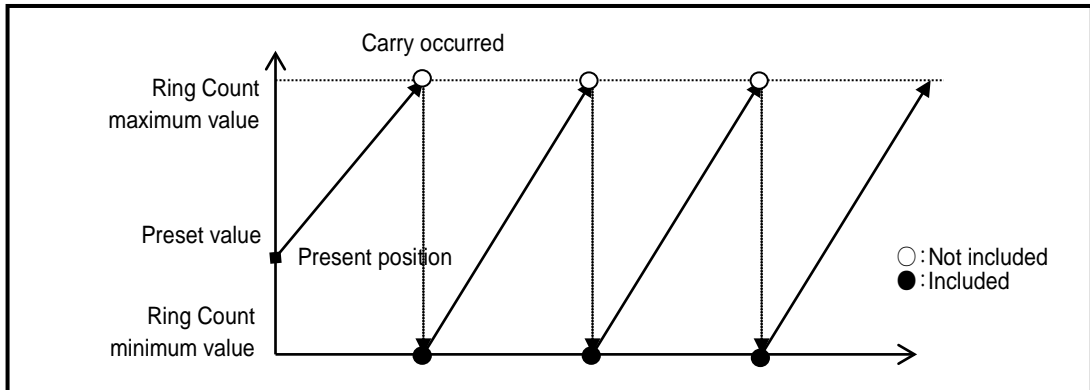

2) During decreasing count

- Even if count value exceeds user-defined minimum value during decreasing count, Borrow only occurs and count does not stop differently to Linear Count.

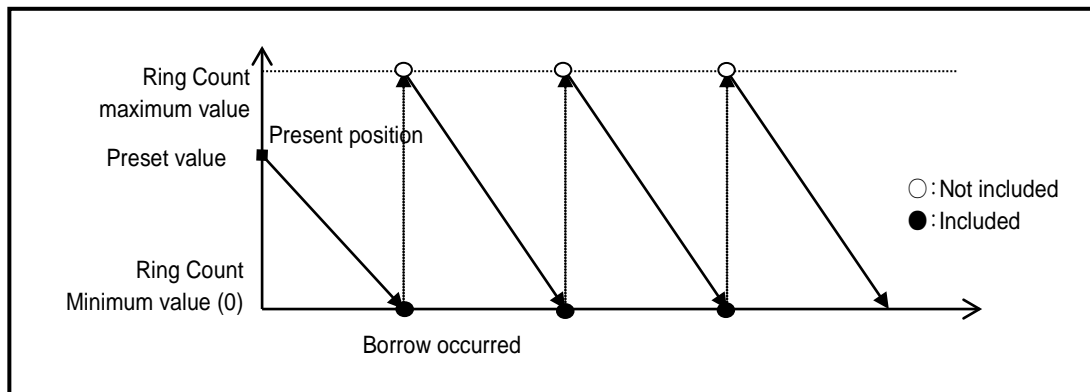

3) Operation when setting Ring Count based on present count value (during increasing count)

- When setting the ring count, the current count value is below the minimum value of the ring counter.
 - Opens an error (Code No. 27), operates as a linear counter, and operates as a ring count when the current count value falls within the range of the ring count (error codes are not cleared).
- When setting the ring count, the current count value is above the maximum value of the ring counter.
 - Displays an error (Code No. 27), operates as a linear counter, and stops counting when the current count value reaches the maximum count value (error code is not cleared).
- When setting the ring count, the current count value is within the user setting range
 - It starts to increase from the current count value, increases to the maximum value set by the user, then becomes the minimum value set by the user and continues to count after carrying a carry.
 - As shown in the figure below, the maximum value is not displayed and the count continues after displaying the minimum value.

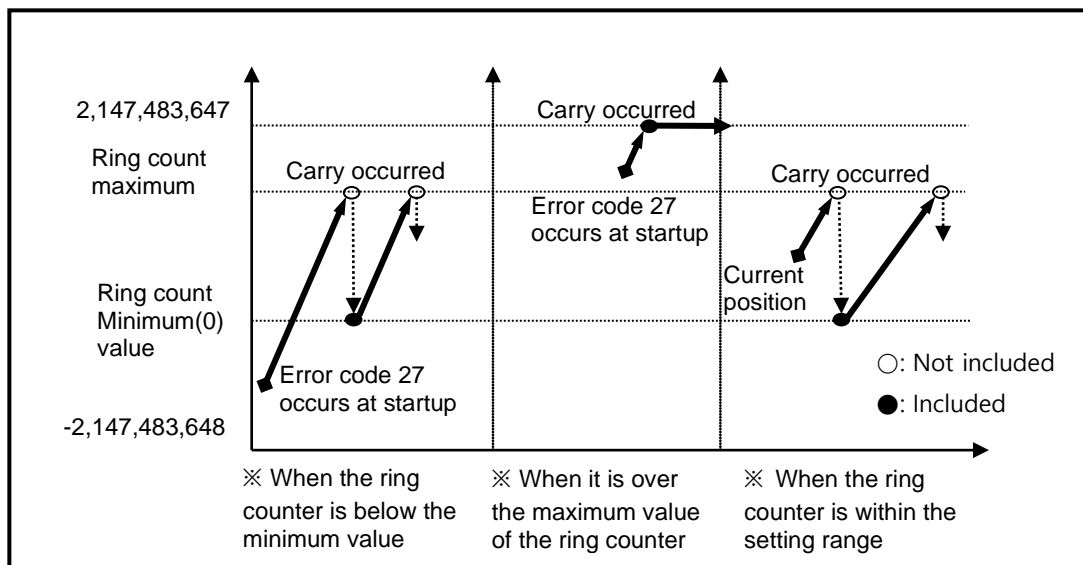

4) Operation when setting Ring Count based on present count value (during decreasing count)

- When setting the ring count, the current count value is below the minimum value of the ring counter.
 - When an error (Code No. 27) is displayed, it operates as a linear counter, and if the current count value falls within the range of the ring count, it operates as a ring count. (The error code is not cleared)
- When setting the ring count, the current count value is above the maximum value of the link counter.
 - An error (Code No. 27) is displayed, and it operates as a linear counter, but stops counting when the current count value reaches the count minimum value. (The error code is not cleared)
- When setting the ring count, the current count value is within the user setting range
 - It starts to decrease from the current count value, decreases to the minimum value set by the user, and becomes the maximum value set by the user, and then continues counting after Borrow occurs.

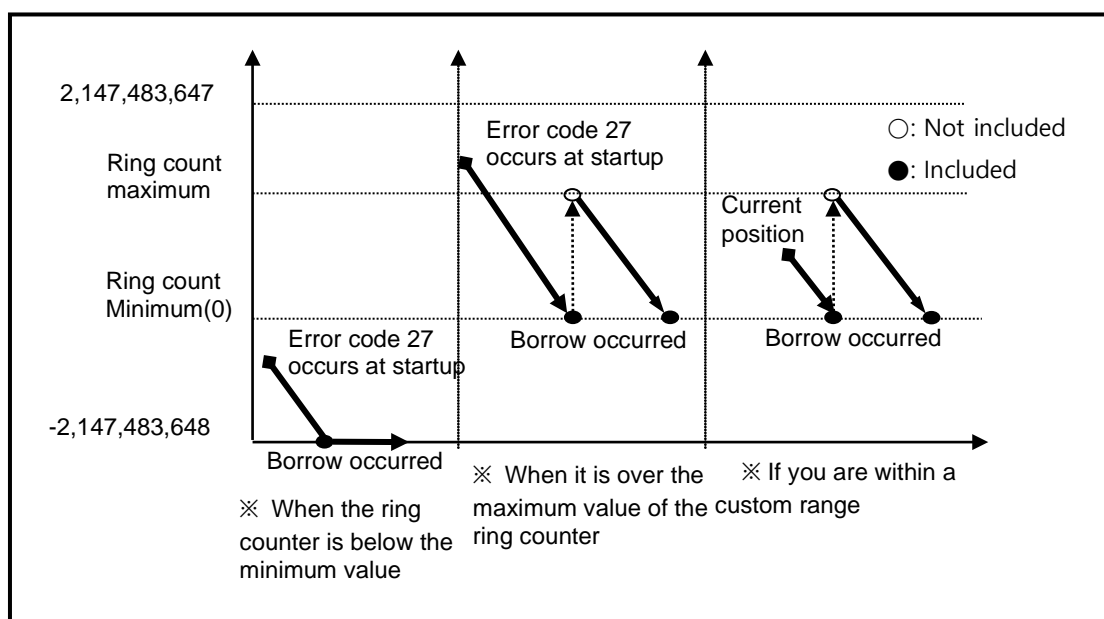

Remark

(1) When using a ring count, be sure to place the count value within the range using a preset or the like.

(4) Compared output

- (a) High Speed counter module has a compared output function used to compare present count value with compared value in size to output as compared.
- (b) Available compared outputs are 2 for 1 channel, which can be used separately.
- (c) Compared output conditions are 7 associated with >, =, < .
- (d) Parameter setting
 - Compared output mode setting

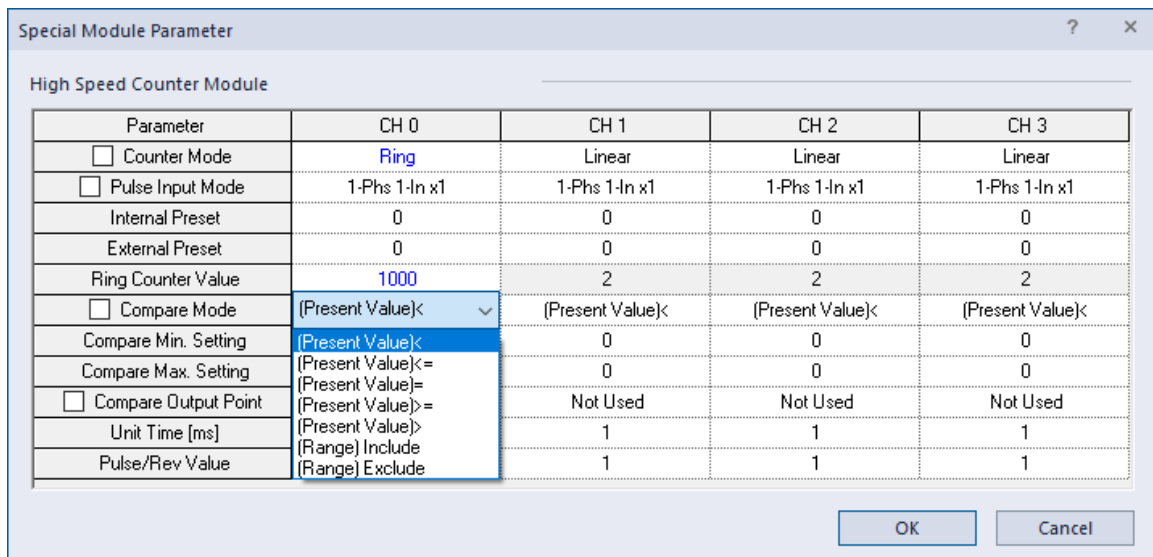

- Upper setting value is saved in special K area.

Compared output condition	Memory address (word)	Value*2)
Present Value < Compared Value	Channel 0 : K302 Channel 1 : K330 Channel 2 : K358 Channel 3 : K386	Set to "0"
Present Value ≤ Compared Value		Set to "1"
Present Value = Compared Value		Set to "2"
Present Value ≥ Compared Value		Set to "3"
Present Value > Compared Value		Set to "4"
Compared value 1 ≤ Count value ≤ Compared value 2		Set to "5"
Count value ≤ Compared value 1, Count value ≥ Compared value 2		Set to "6"

*2) If compared output value not set to 0-6 using counter, error code '23' will be occurred.

- In order to make actual comparison enabled after compared output condition set, the compared enable signal is to be On.

Classification	Area per channel				Operation
	Ch. 0	Ch. 1	Ch. 2	Ch. 3	
Count enable signal	K2600	K2700	K2800	K2900	0: N/A, 1: enable
Compared enable signal	K2604	K2704	K2804	K2904	0: forbidden, 1: enable

- In order to make external output, the compared equivalent output signal (P20~P27) must be set. If Compared output contact is Off, Compared coincidence output signal (internal device) is only output.

Classification	Area per channel				Operation
	Ch. 0	Ch. 1	Ch. 2	Ch. 3	
Compared equivalent output signal	K2612	K2712	K2812	K2912	0: Compared output not equivalent 1: Compared output equivalent

- Comp output point (P20 ~ P27) setting

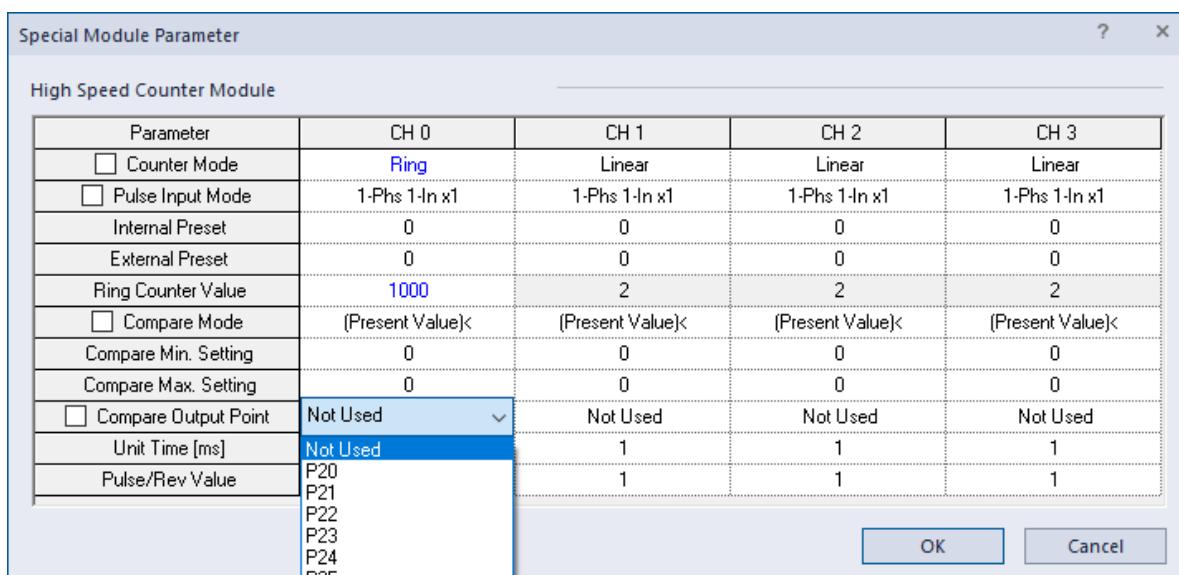

(e) Detailed description for compared output

A) Mode 0 (Present value < Compared value)

- If counted present value is less than compared value, output is sent out, and if present value increases to be equal to or greater than compared value, output is not sent out.

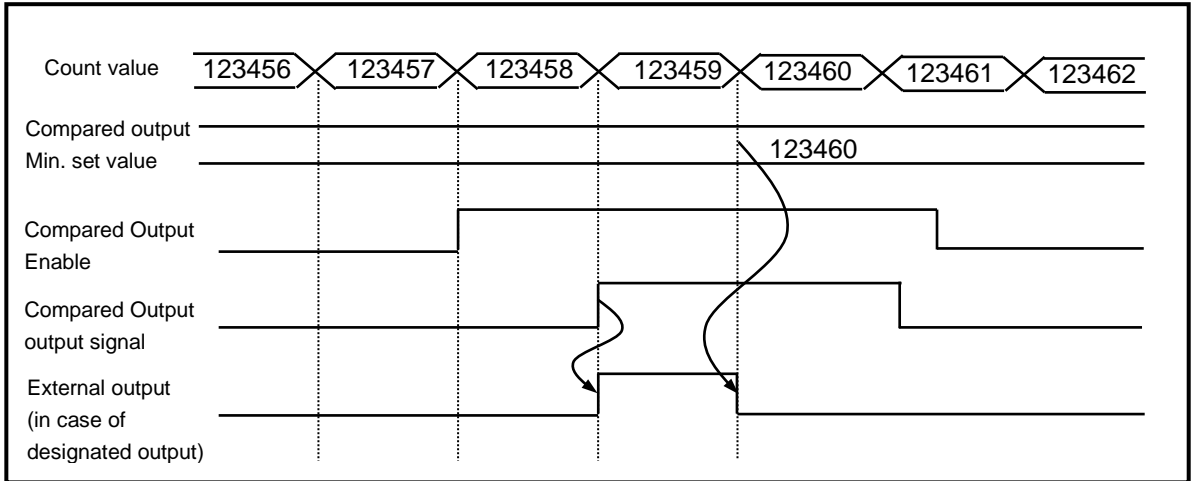

B) Mode1 (Count value ≤ Compared value)

- If present count value is less than or equal to compared value, output is sent out, and if count value increases to be greater than compared value, output is not sent out.

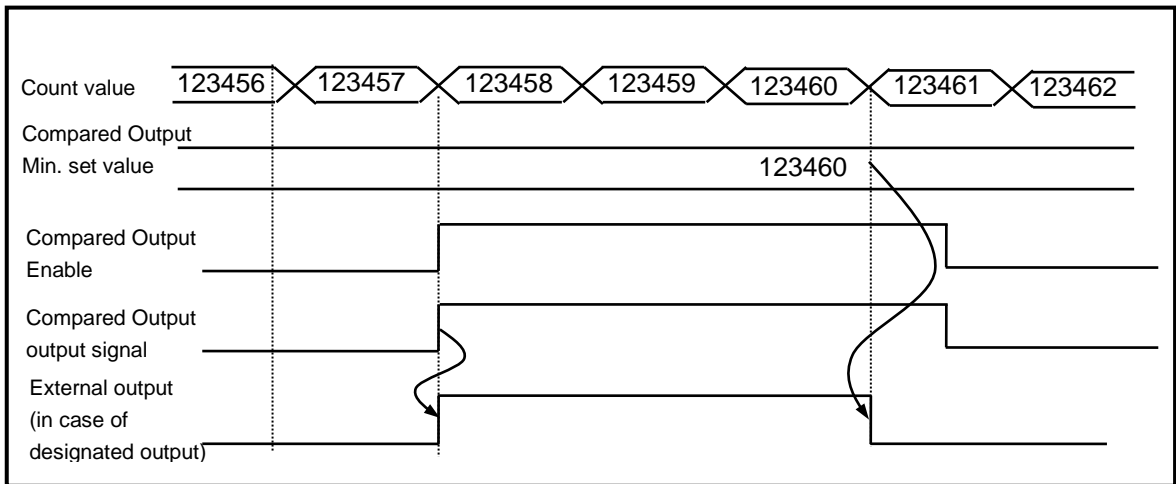

C) Mode 2 (Count value = Compared value)

- If present count value is equal to compared value, output is sent out. In order to turn the output Off, Compared output Enable and Compared output signal is to be On.

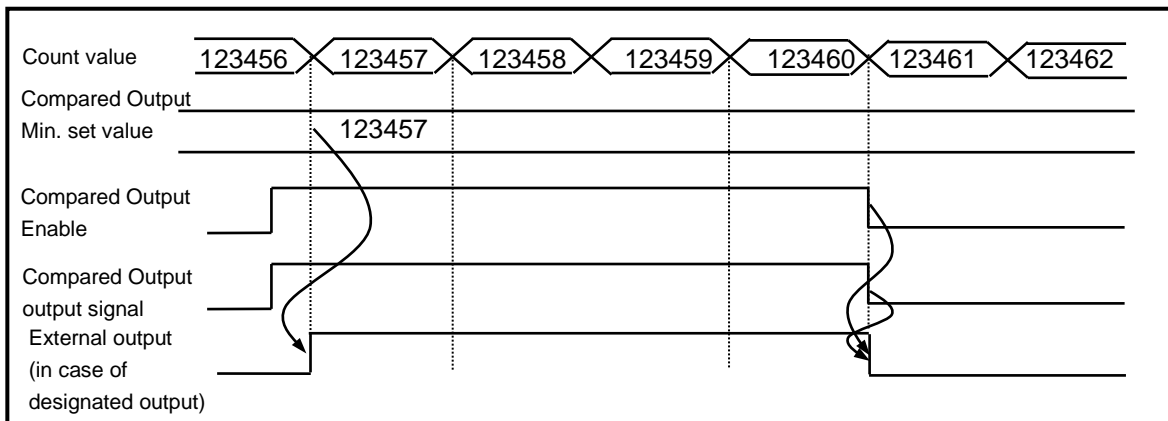

D) Mode 3 (Count value \geq Compared value)

- If present count value is greater than or equal to compared value, output is sent out, and if count value decreases to be less than compared value, output is not sent out.

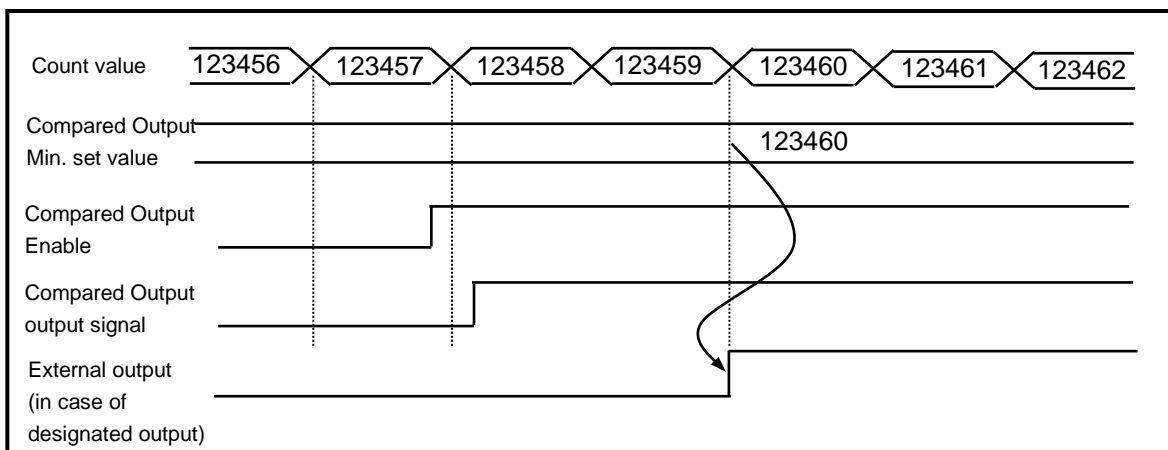

E) Mode 4 (Count value > Compared value)

- If present count value is greater than compared value, output is sent out, and if count value decreases to be less than or equal to compared value, output is not sent out.

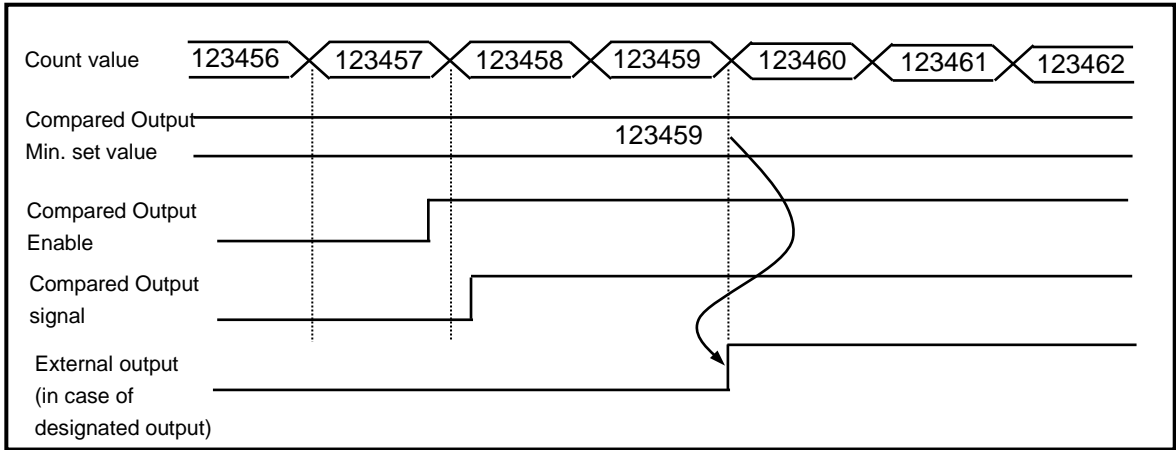

F) Mode 5

(Compared output Min. set value ≤ Count value ≤ Compared output Max. set value)

- If present count value is greater than or equal to compared output Min. value and less than or equal to compared output Max. set value, output is sent out, and if count value increases/decreases to exceed compared value's range, output is not sent out.

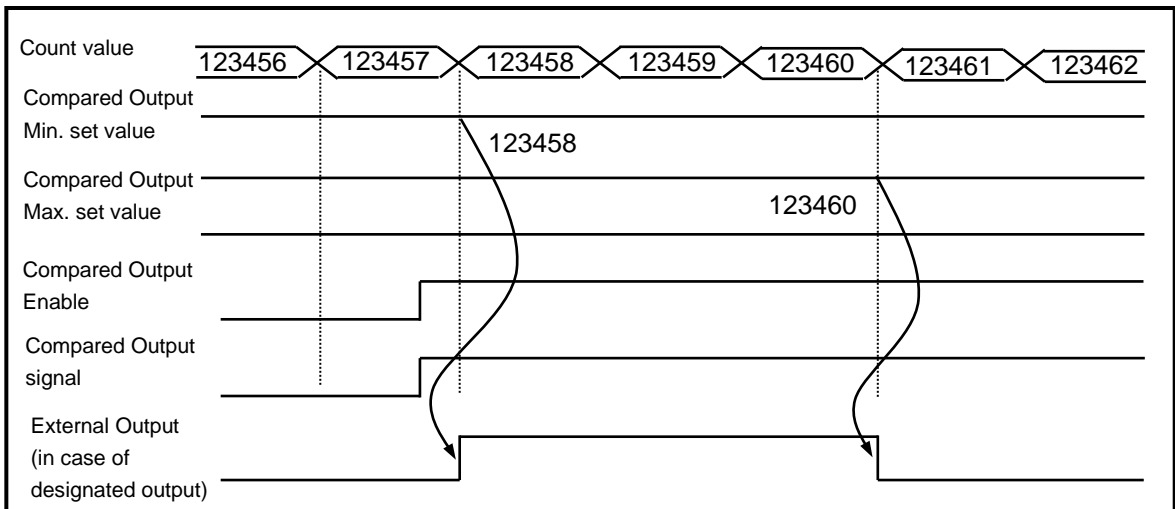

G) Mode 6 (Count value \leq Compared output Min. value, Count value \geq Compared output Max. value)

- If present count value is less than or equal to compared output Min. value and greater than or equal to compared output Max. value, output is sent out, and if count value increases/decreases to exceed compared value's range, output is not sent out.

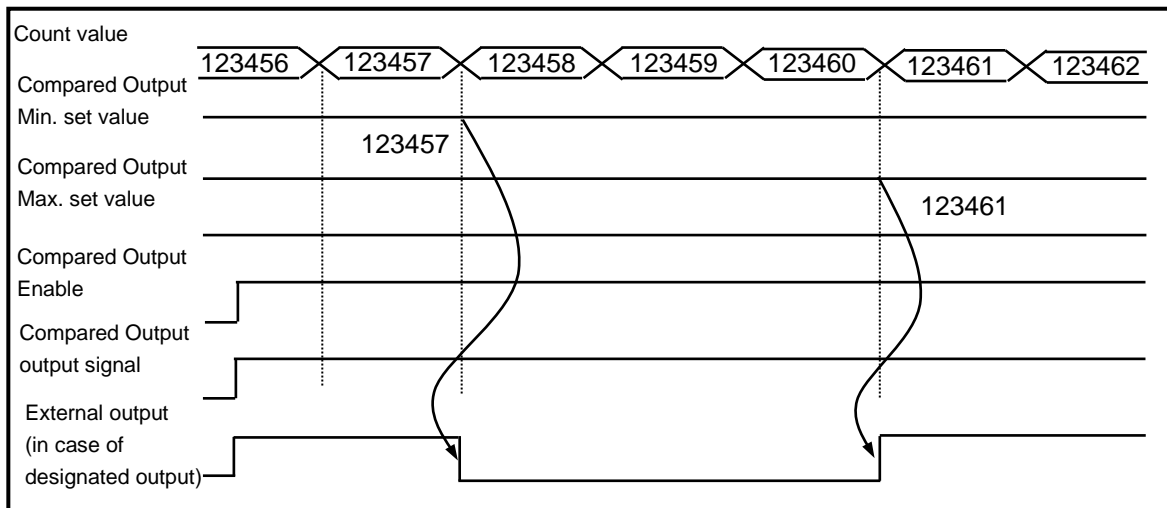

(5) Carry signal

A) Carry signal occurs

- (1) When count range maximum value of 2,147,483,647 is reached during Linear Count.
- (2) When user-defined maximum value of Ring Count changed to the minimum value during Ring Count.

B) Count when Carry Signal occurs

- (1) Count stops if Carry occurs during Linear Count.
- (2) Count does not stop even if Carry occurs during Ring Count.

C) Carry reset

- (1) The Carry generated can be cancelled by Carry/Borrow reset signal On.

Classification	Device area per channel			
	Channel 0	Channel 1	Channel 2	Channel 3
Carry signal	K2610	K2710	K2810	K2910

(6) Borrow signal

A) Borrow signal occurs

- (1) When count range minimum value of -2,147,483,648 is reached during Linear Count.
- (2) When user-defined minimum value of Ring Count changed to the maximum value during Ring Count.

B) Count when Borrow signal occurs

- (1) Count stops if Borrow occurs during Linear Count.
- (2) Count does not stop even if Borrow occurs during Ring Count.

C) Borrow reset

- (1) The Borrow generated can be cancelled by Carry/Borrow reset signal On..

Classification	Device area per channel			
	Channel 0	Channel 1	Channel 2	Channel 3
Borrow signal	K2611	K2711	K2811	K2911

(7) Revolution/Unit time

While auxiliary mode enable signal is On, it counts the number of input pulses for a specified time.

A) Setting

(1) Unit time setting

1) Input unit time and pulse number per 1 revolution

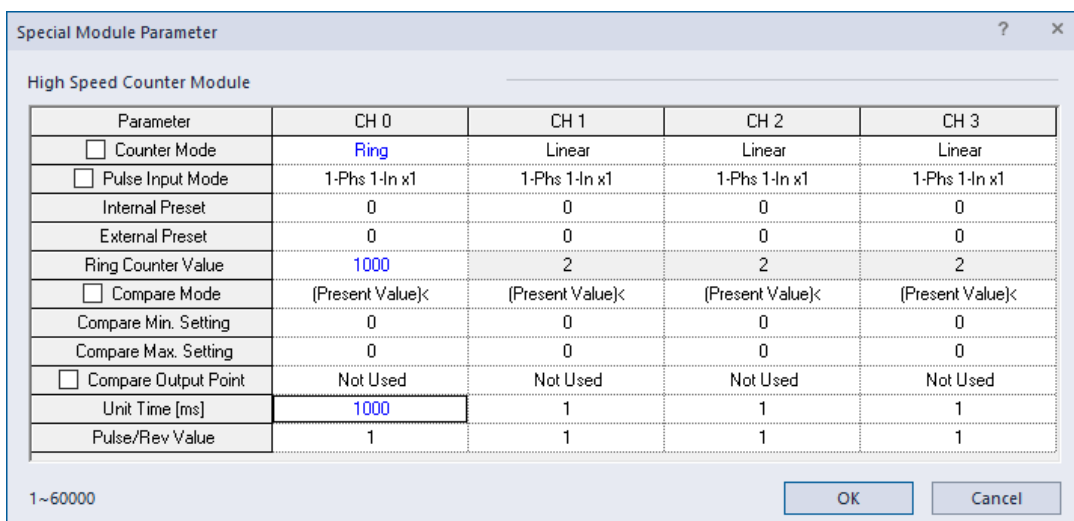

Setting value is saved at the following special K are and user can designate it directly.

Classification	Device area per channel			
	Channel 0	Channel 1	Channel 2	Channel 3
Unit time (1~60000ms) ^{*3)}	K322	K352	K382	K412

^{*3)} If revolution per unit time is enabled and unit time value is other than 1~60000ms, error code '34' occurs.

2) Input pulse number per 1 revolution

Classification	Device area per channel			
	Channel 0	Channel 1	Channel 2	Channel 3
Pulse number /revolution (1~60000) ^{*4)}	K323	K353	K383	K413

^{*4)} If revolution per unit time is enabled and pulse number/revolution is other than 1~60000, error code '35' occurs.

3) If Count function of revolution per unit time is used, enable signal set by On.

Classification	Device area per channel			
	Channel 0	Channel 1	Channel 2	Channel 3
Revolution/unit time command	K2605	K2705	K2805	K2905

B) Count function of Revolution per Unit time is used to count the number of pulses for a specified time while Enable signal is On.

- C) With the displayed number of pulses updated for a specified time and the number of pulses per revolution input, Revolution/Unit time can be counted.
- D) Number of Revolution per 1 second is indicated after number of pulse per 1 revolution is set and time is set to 1 second (1000ms). In order to indicate by Revolutions per minute (RPM), the operation is executed in program.
- E) The example that number of pulse per 1 revolution set to '1' and time is set to 1000 ms is as shown below. (Ch0)

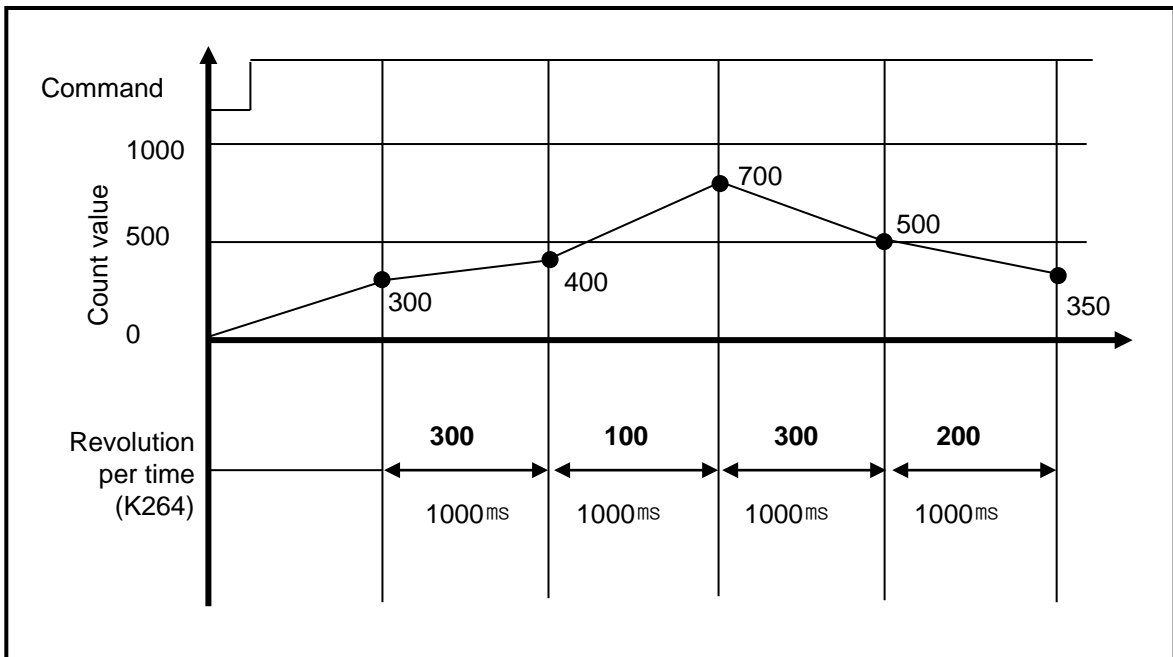

- F) In order to indicate revolution per minute (RPM), the program is as shown below. In case of DMUL operation, RPM value is saved 64 bit in D100~D103. If operated RPM value is used, it can use to Word or Dword type according to system (case of RPM value is small number).

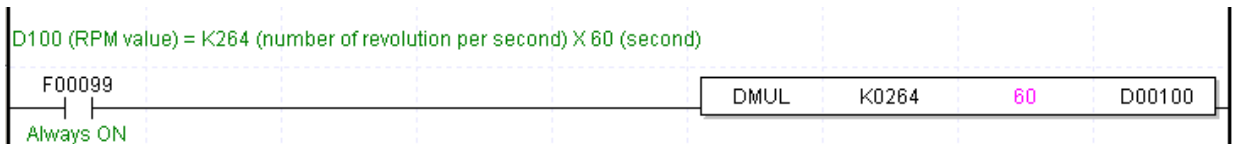

G) The example that number of pulse per 1 revolution set to '10' and time is set to 60,000 ms is as shown below.

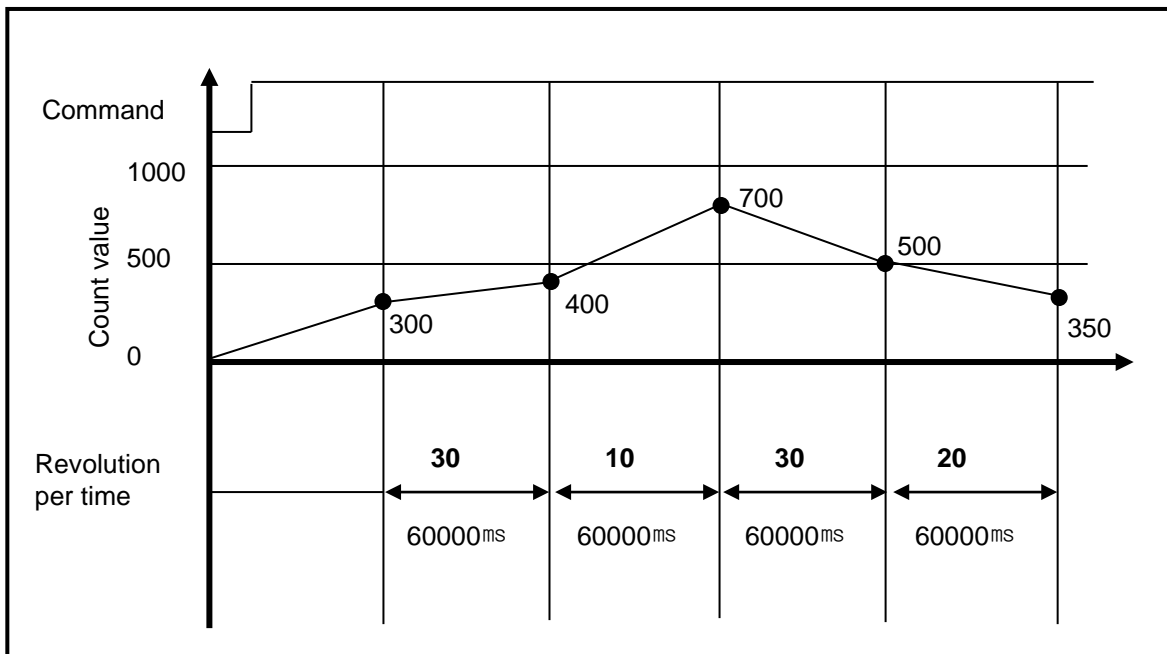

(8) Count latch

(a) When Count latch signal is On, present count value is latched.

(b) Setting

If present counter value is to latch, Count Latch function is set 'Use'.

Classification	Device area per channel			
	Channel 0	Channel 1	Channel 2	Channel 3
Count latch command	K2606	K2706	K2806	K2906

- Count latch function is operated when Count latch signal is On. Namely, counter value is not cleared when power supply Off =>On and mode change, it is counted from previous value.
- In latch counter function, internal or external preset function has to use for clearing present value.

(9) Preset function

It changes the current value into preset value.

There are two types of preset function, internal preset and external preset. External preset is fixed as input contact point.

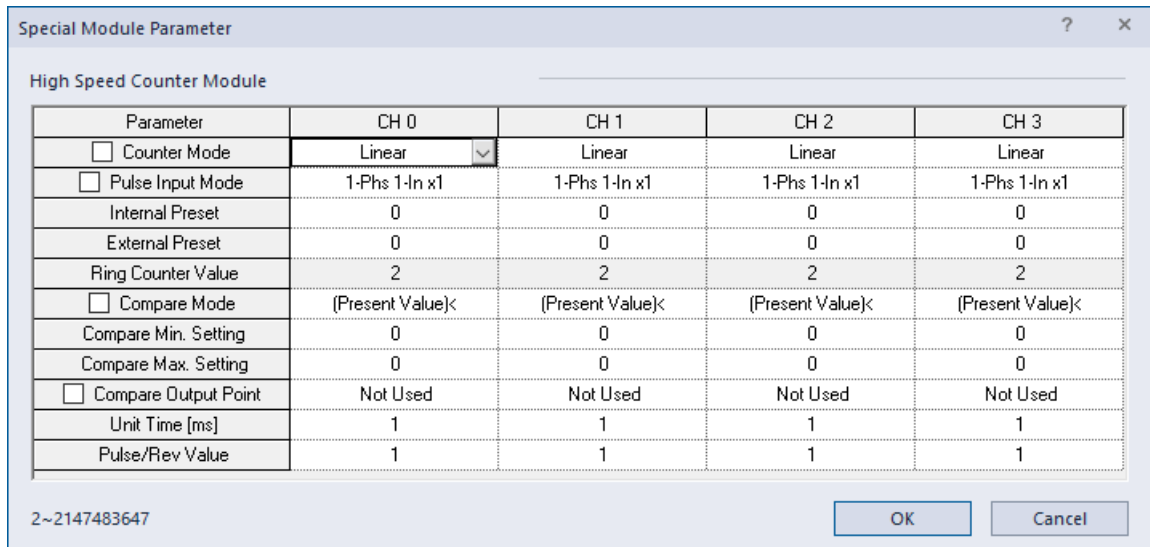

- Preset setting value is saved at the following special K area.

Type	Area per each channel (Double word)				Ref.
	Ch.0	Ch.1	Ch.2	Ch.3	
Internal preset	K304	K334	K364	K394	-
External preset	K306	K336	K366	K396	-

- Preset command is specified through the following special K area, external preset is used by executing the designated input contact point after allowance bit is on.

Type	Area per each channel (Bit)				Ref.
	Ch.0	Ch.1	Ch.2	Ch.3	
Internal preset command	K2601	K2701	K2801	K2901	-
External preset allowance	K2602	K2702	K2802	K2902	-
External preset command	P008	P009	P00A	P00B	-

8.1.4 “H” type Functions

(1) Counter mode

A) High Speed counter module can count High Speed pulses which can not be processed by CPU module's counter instructions (CTU, CTD, CTUD, etc.), up to binary value of 32 bits (-2,147,483,648 ~ 2,147,483,647).

B) Available input is 1-phase input, 2-phase input and CW/ CCW input.

C) Count increasing/decreasing methods are as follows;

(1) For 1-phase input: (1) Increasing/decreasing count operation by program setting

(2) Increasing/decreasing count operation by B-phase input signal

(2) For 2-phase input: setting by difference in phase between A-phase and B-phase

(3) For CW/CCW input: Increasing operation if B-phase is LOW with A-phase input, and Decreasing operation if A-phase is LOW with B-phase input.

D) Auxiliary modes are as follows;

① Count Latch

② Count function about the number of revolution per unit time

E) Pulse input mode

1) 1 phase count mode

A) Increasing/decreasing count operation by program setting

a) 1-phase 1-input 1-multiplication operation mode

A-phase input pulse counts at rising and increasing/decreasing will be decided by the applicable program.

Increasing/Decreasing classification	A-phase input pulse rising	A-phase input pulse falling
Increasing/decreasing count setting signal Off	Increasing count	-
Increasing/decreasing count setting signal On	Decreasing count	-

• Operation example

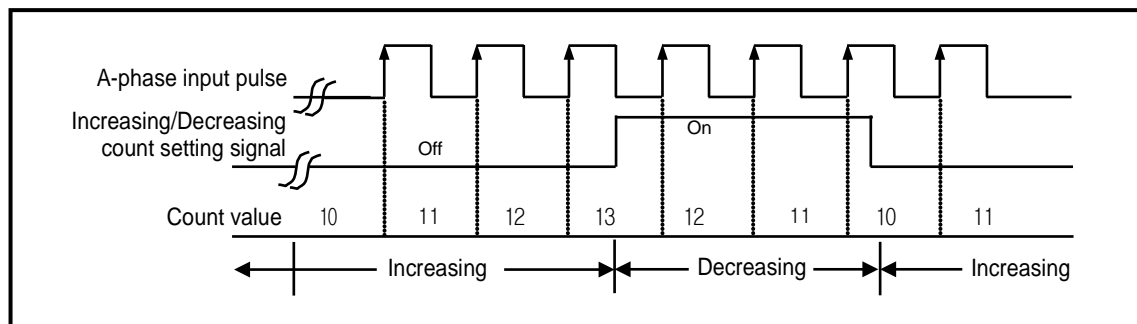

B) Increasing/decreasing count operation by B-phase input signal

b) 1-phase 2-input 1-multiplication operation mode

A-phase input pulse counts at rising and increasing/decreasing will be decided by B-phase.

Increasing/Decreasing classification	A-phase input pulse rising	A-phase input pulse falling
B-phase input pulse Off	Increasing count	-
B-phase input pulse On	Decreasing count	-

• Operation example

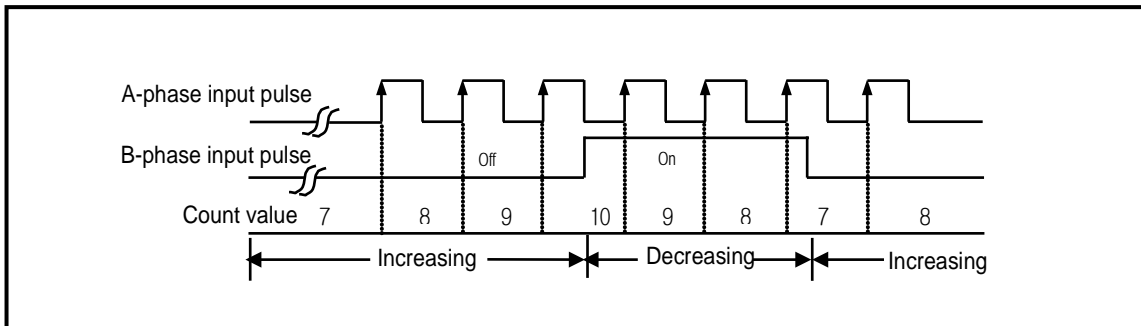

2) 2-phase count mode

a) 2-phase 4-multiplication operation mode

A-phase input pulse and B-phase input pulse count at rising/falling respectively. If A-phase input is antecedent to B-phase input, increasing operation starts, and if B-phase input is antecedent to A-phase input, decreasing operation starts.

• Operation example

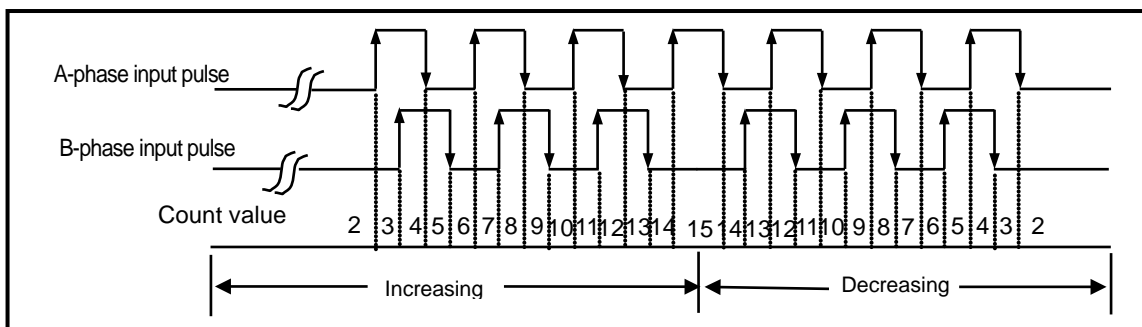

3) CW(Clockwise)/CCW(Counter Clockwise) operation mode

A-phase input pulse counts at rising , or B-phase input pulse counts at rising.

Increasing operation executed when B-phase input pulse is Low with A-phase input pulse at rising, and Decreasing operation executed when A-phase input pulse is Low with B-phase input pulse at rising.

Increasing/Decreasing classification	A-phase input pulse High	A-phase input pulse Low
B-phase input pulse High	-	decreasing count
B-phase input pulse Low	Increasing count	-

• Operation example

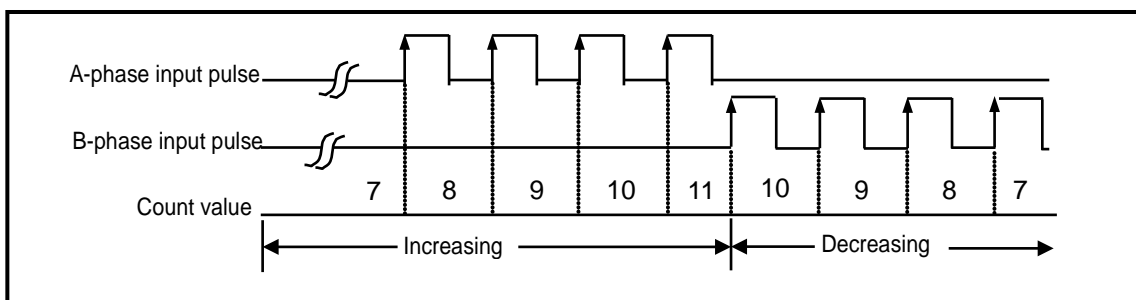

(2) Counter type

2 types of count (Linear counter, Ring counter) can be selected for the applicable use based on functions.

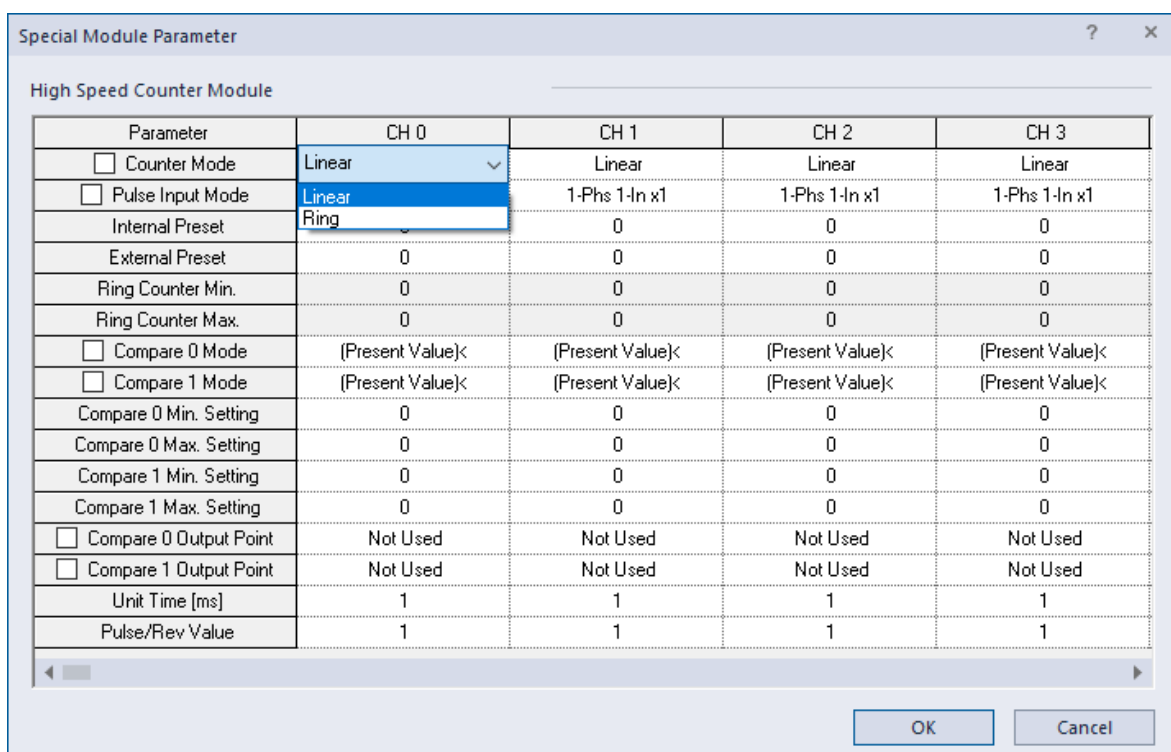

• Counter mode is saved at the following special K area.

Mode	Area per each channel (word)								Ref.
	Ch.0	Ch.1	Ch.2	Ch.3	Ch.4	Ch.5	Ch.6	Ch.7	
Counter mode	K300	K330	K360	K390	K2220	K2250	K2280	K2310	0 : linear 1 : ring

A) Linear counter

- Linear Count range: -2,147,483,648 ~ 2,147,483,647
- If count value reaches the maximum value while increased, Carry will occur, and if count value reaches the minimum value while decreased, Borrow will occur.
- If Carry occurs, count stops and increasing is not available but decreasing is available.
- If Borrow occurs, count stops and decreasing is not available but increasing is available.

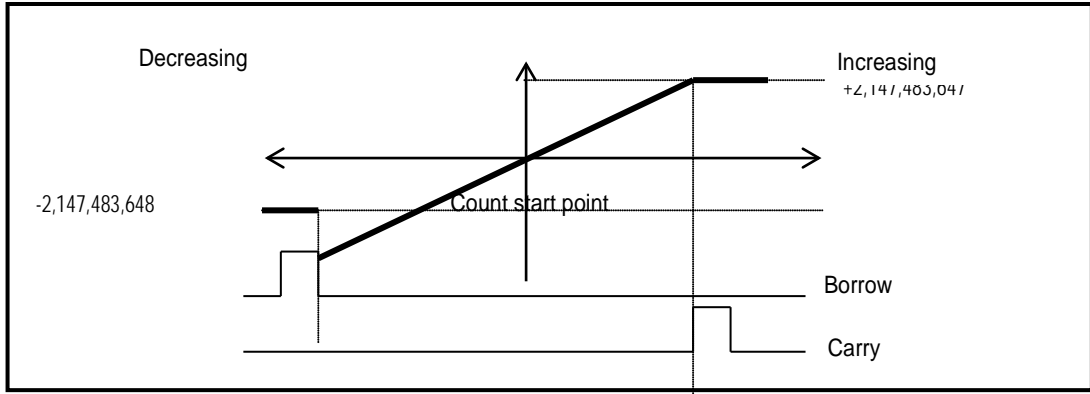

B) Ring count

Set Ring Counter Min. Value and Max. value. Preset value and compared set value should be in range of ring counter min. value and max. value.

Special Module Parameter

High Speed Counter Module

Parameter	CH 0	CH 1	CH 2	CH 3
<input type="checkbox"/> Counter Mode	Ring	Linear	Linear	Linear
<input type="checkbox"/> Pulse Input Mode	1-Phs 1-In x1	1-Phs 1-In x1	1-Phs 1-In x1	1-Phs 1-In x1
Internal Preset	0	0	0	0
External Preset	0	0	0	0
Ring Counter Min.	0	0	0	0
Ring Counter Max.	3000	0	0	0
<input type="checkbox"/> Compare 0 Mode	(Present Value)<	(Present Value)<	(Present Value)<	(Present Value)<
<input type="checkbox"/> Compare 1 Mode	(Present Value)<	(Present Value)<	(Present Value)<	(Present Value)<
Compare 0 Min. Setting	0	0	0	0
Compare 0 Max. Setting	0	0	0	0
Compare 1 Min. Setting	0	0	0	0
Compare 1 Max. Setting	0	0	0	0
<input type="checkbox"/> Compare 0 Output Point	Not Used	Not Used	Not Used	Not Used
<input type="checkbox"/> Compare 1 Output Point	Not Used	Not Used	Not Used	Not Used
Unit Time [ms]	1	1	1	1
Pulse/Rev Value	1	1	1	1

1~2147483647

OK Cancel

- Ring counter max. and min value is saved at the following special K area.

type	Area per each channel (Double word)								Ref.
	Ch.0	Ch.1	Ch.2	Ch.3	Ch.4	Ch.5	Ch.6	Ch.7	
Ring counter min. value	K308	K338	K368	K398	K2228	K2258	K2288	K2318	-
Ring counter max. value	K310	K340	K270	K400	K2230	K2260	K2290	K2320	-

- Range of Ring counter: user defined min. value ~ user defined max. value
- Counter display: in case of using ring counter, user defined max. value is not displayed.
 - a. During increasing count
 - Even if count value exceeds user-defined maximum value during increasing count, Carry only occurs and count does not stop differently to Linear Count.

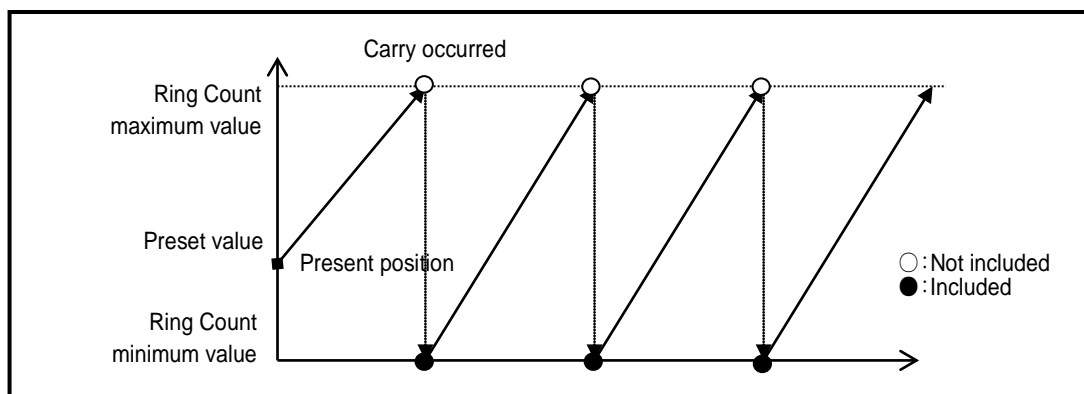

- b. During decreasing count
 - Even if count value exceeds user-defined minimum value during decreasing count, Borrow only occurs and count does not stop differently to Linear Count.

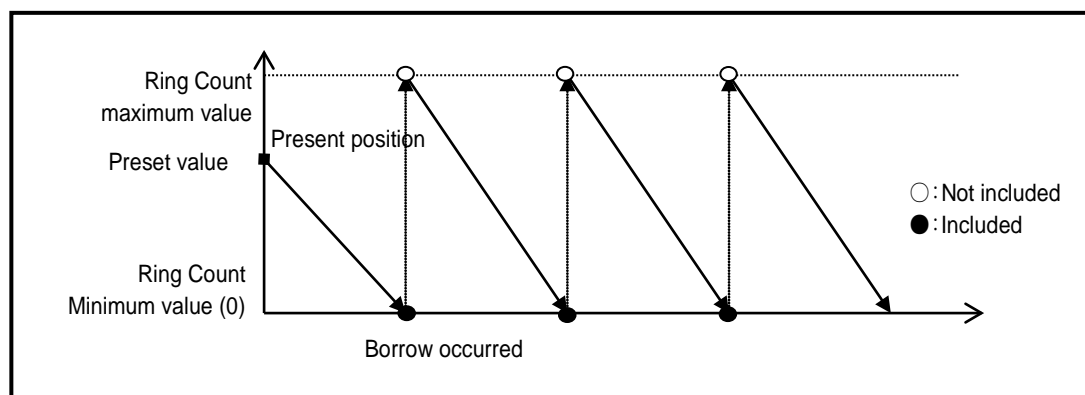

- c. Operation when setting Ring Count based on present count value (during increasing count)
 - When setting the ring count, the current count value is below the minimum value of the ring counter.
 - Opens an error (Code No. 27), operates as a linear counter, and operates as a ring count when the current count value falls within the range of the ring counter (error codes are not cleared).
 - When setting the ring count, the current count value is above the maximum value of the ring counter.
 - Displays an error (Code No. 27), operates as a linear counter, and stops counting when the current count value reaches the maximum count value (error code is not cleared).
 - When setting the ring count, the current count value is within the user setting range
 - It starts to increase from the current count value, increases to the maximum value set by the user, then becomes the minimum value set by the user and continues to count after carrying a carry.
 - As shown in the figure below, the maximum value is not displayed and the count continues after displaying the minimum value.

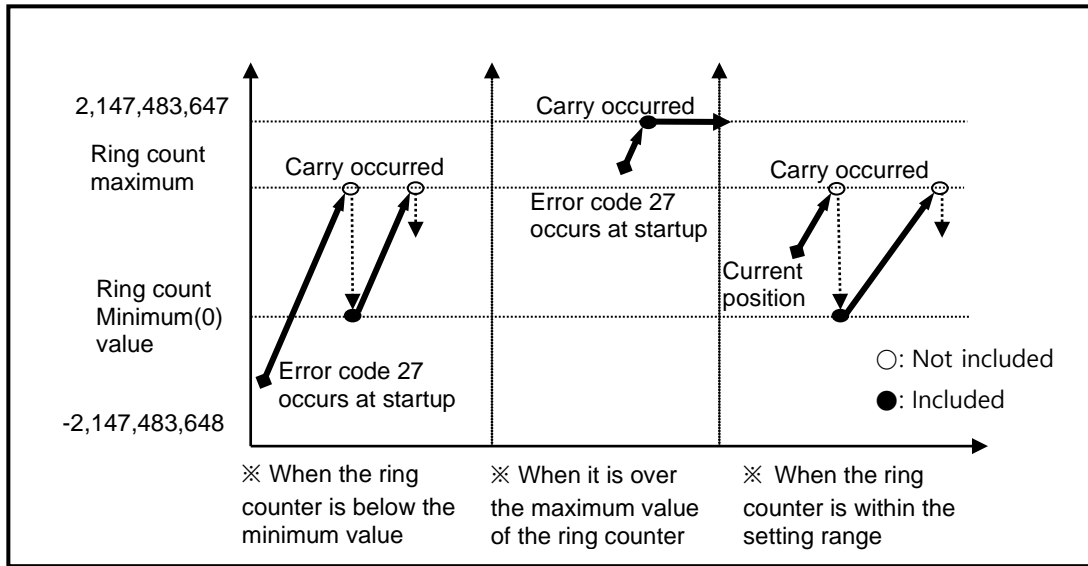

d. Operation when setting Ring Count based on present count value (during decreasing count)

- When setting the ring count, the current count value is below the minimum value of the ring counter.
 - When an error (Code No. 27) is displayed, it operates as a linear counter, and if the current count value falls within the range of the ring count, it operates as a ring count. (The error code is not cleared)
- When setting the ring count, the current count value is above the maximum value of the link counter.
 - An error (Code No. 27) is displayed, and it operates as a linear counter, but stops counting when the current count value reaches the count minimum value. (The error code is not cleared)
- When setting the ring count, the current count value is within the user setting range
 - It starts to decrease from the current count value, decreases to the minimum value set by the user, and becomes the maximum value set by the user, and then continues counting after Borrow occurs.

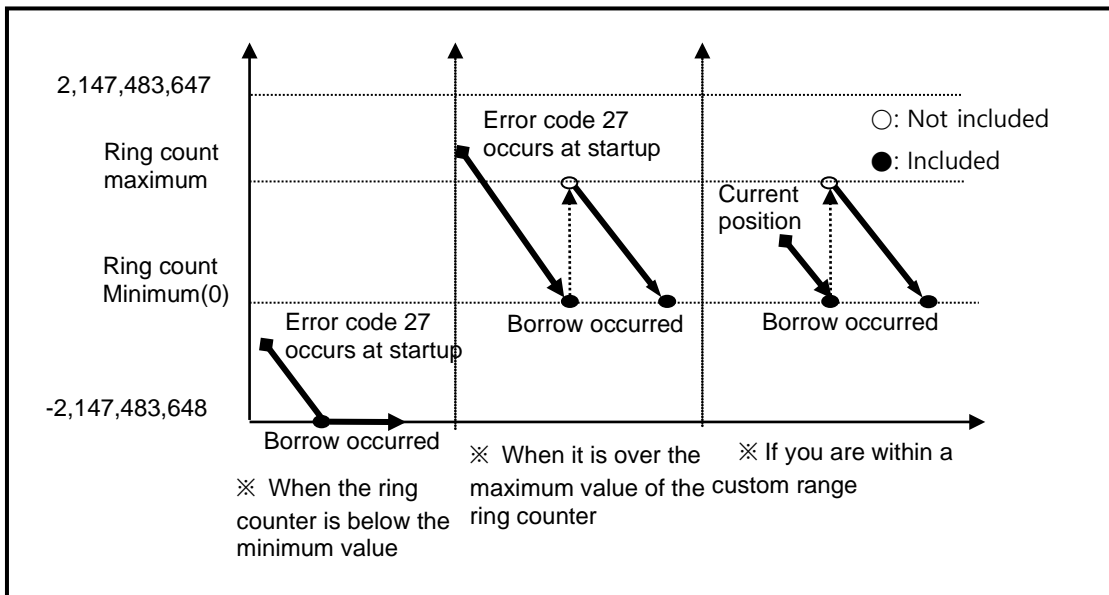

Remark

(1) When using a ring count, be sure to place the count value within the range using a preset or the like.

(3) Compared output

- (a) High Speed counter module has a compared output function used to compare present count value with compared value in size to output as compared.
- (b) Available compared outputs are 2 for 1 channel, which can be used separately.
- (c) Compared output conditions are 7 associated with >, =, < .
- (d) Parameter setting
 - Comp. output mode setting

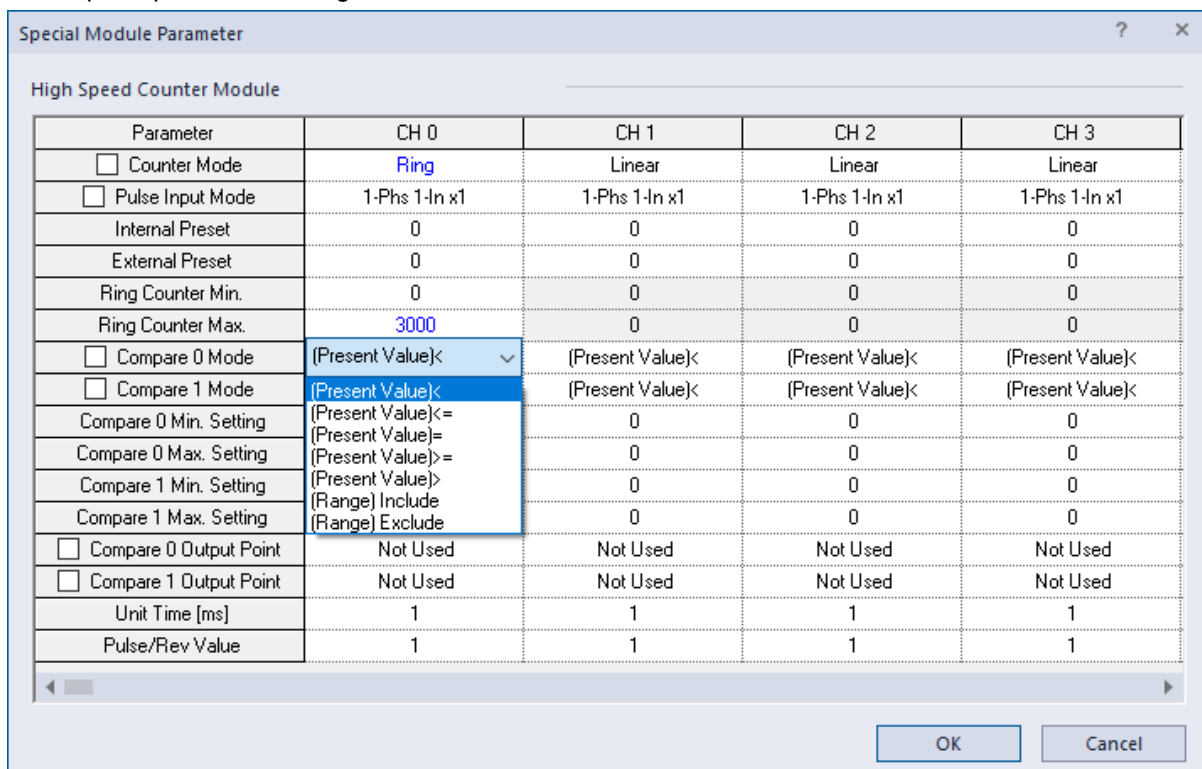

- Upper setting value is saved in special K area.

Compared output condition	Memory address (word)		Value*2)
	Comp output 0	Comp output 1	
Present Value < Compared Value			Set to "0"
Present Value ≤ Compared Value	Ch.0 K302	Ch.0 K303	Set to "1"
Present Value = Compared Value	Ch.1 K332	Ch.1 K333	Set to "2"
Present Value ≥ Compared Value	Ch.2 K362	Ch.2 K363	Set to "3"
Present Value > Compared Value	Ch.3 K392	Ch.3 K393	Set to "4"
Compared value 1 ≤ Count value ≤ Compared value 2	Ch.4 K2222	Ch.4 K2223	Set to "4"
	Ch.5 K2252	Ch.5 K2253	Set to "5"
Count value ≤ Compared value 1, Count value ≥ Compared value 2	Ch.6 K2282	Ch.6 K2283	Set to "5"
	Ch.7 K2312	Ch.7 K2313	Set to "6"

*2) If compared output mode set value is other than 0~6 at using counter, error code '23' occurs.

- In order to output the compared output signal, compared output enable flag set to '1' after compared output condition set.

Classification	Area per channel								Operation
	Ch. 0	Ch. 1	Ch. 2	Ch. 3	Ch. 4	Ch. 5	Ch. 6	Ch. 7	
Count enable signal	K2600	K2700	K2800	K2900	K21800	K21900	K22000	K22100	0:disable, 1:enable
Compared 0 enable signal	K2604	K2704	K2804	K2904	K21804	K21904	K22004	K22104	0: disable, 1:enable
Compared 1 enable signal	K2607	K2707	K2807	K2907	K21807	K21907	K22007	K22107	0: disable, 1:enable

- In order to make external output, the compared coincidence output signal (P20~P2F) must be set. If Compared output contact is 'Off' at Special Module Parameter Setting of XG5000, Compared coincidence output signal (internal device) is only output.

Classification	Area per channel							Operation
	Ch. 0	Ch. 1	Ch. 2	Ch.4	Ch.5	Ch. 6	Ch.7	
Compared coincidence output signal 0	K2612	K2712	K2812	K2912	K21812	K22012	K22112	0: Compared output Off 1: Compared output On
Compared coincidence output signal 1	K2613	K2713	K2813	K2913	K21813	K22013	K22113	0: Compared output Off 1: Compared output On

- Comp. output point (P20 ~ P2F) setting

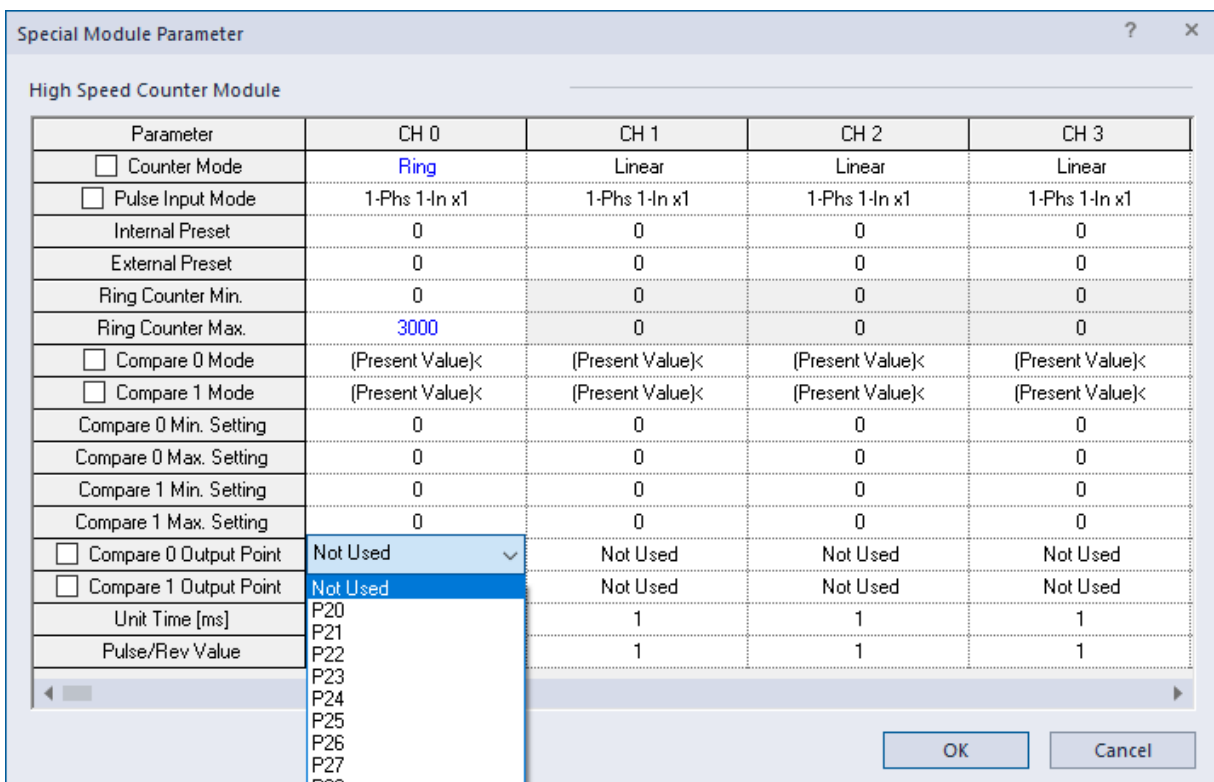

(e) Detail of comparator output

It describes detail of comparator output (based on comparator output 0)

1) Mode 0 (Present value < Compared value)

- If counted present value is less than the minimum value of compared output 0, output is sent out, and if present value increases to be equal to or greater than the minimum value of compared output 0, output is not sent out.

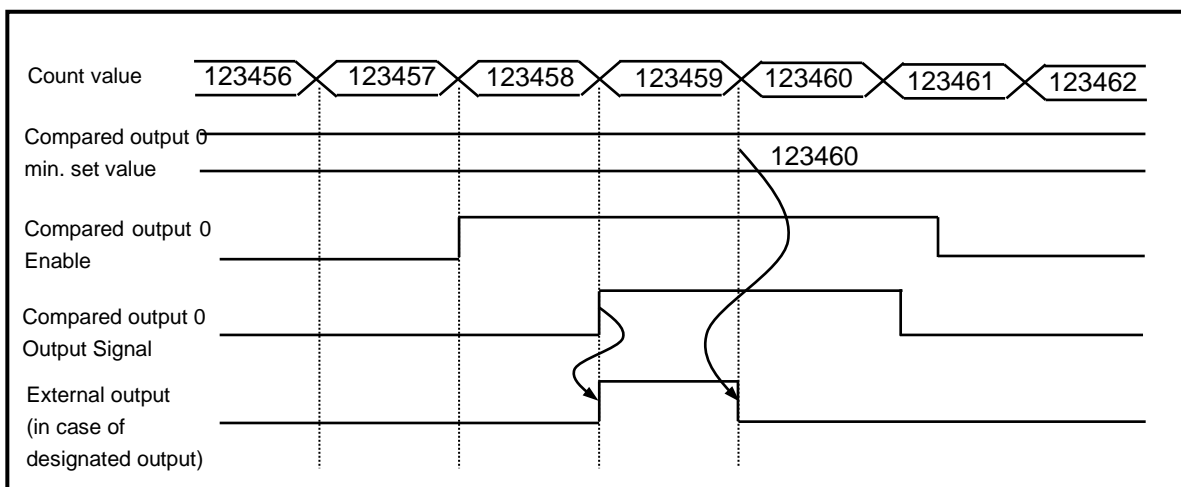

2) Mode1 (Count value ≤ Compared value)

- If present count value is less than or equal to the minimum set value of compared output 0, output is sent out, and if count value increases to be greater than the minimum set value of

compared output 0, output is not sent out.

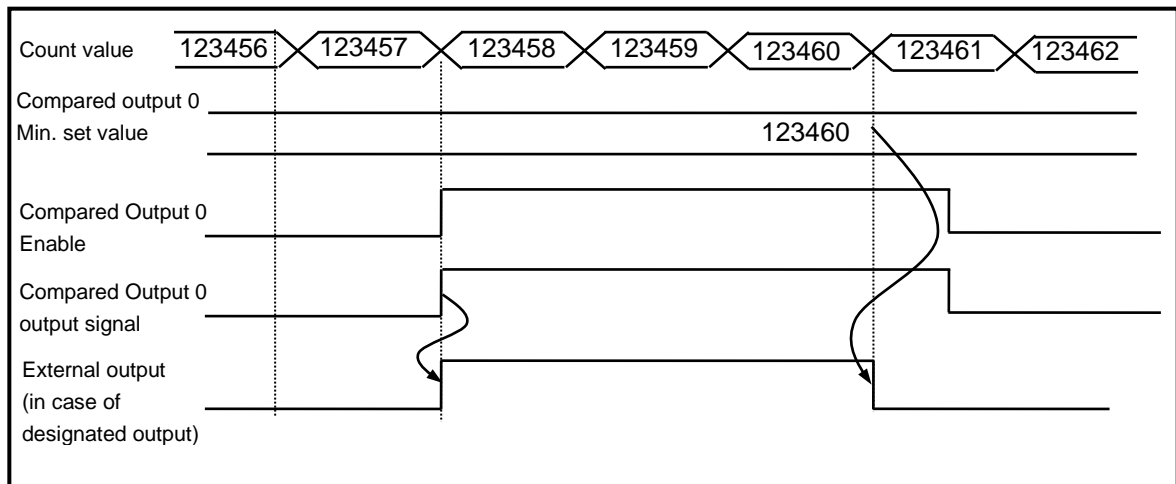

3) Mode 2 (Count value = Compared value)

- If present count value is equal to the minimum set value of compared output 0, output is sent out. In order to turn the output Off, Compared output Enable signal 0 or Compared Coincidence Output Enable signal 0 is to be Off.

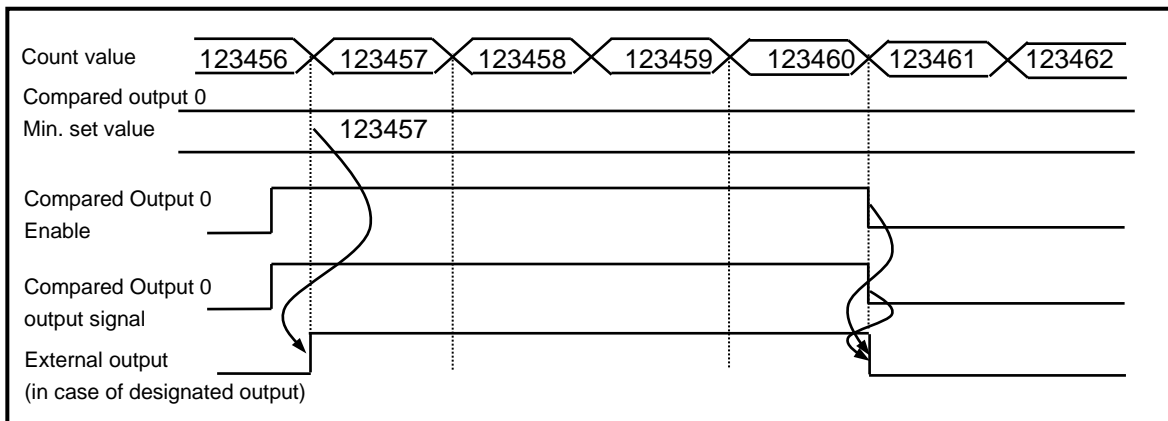

D) Mode 3 (Count value \geq Compared value)

- If present count value is greater than or equal to the minimum set value of compared output 0, output is sent out, and if count value decreases to be less than the minimum set value of compared output 0, output is not sent out.

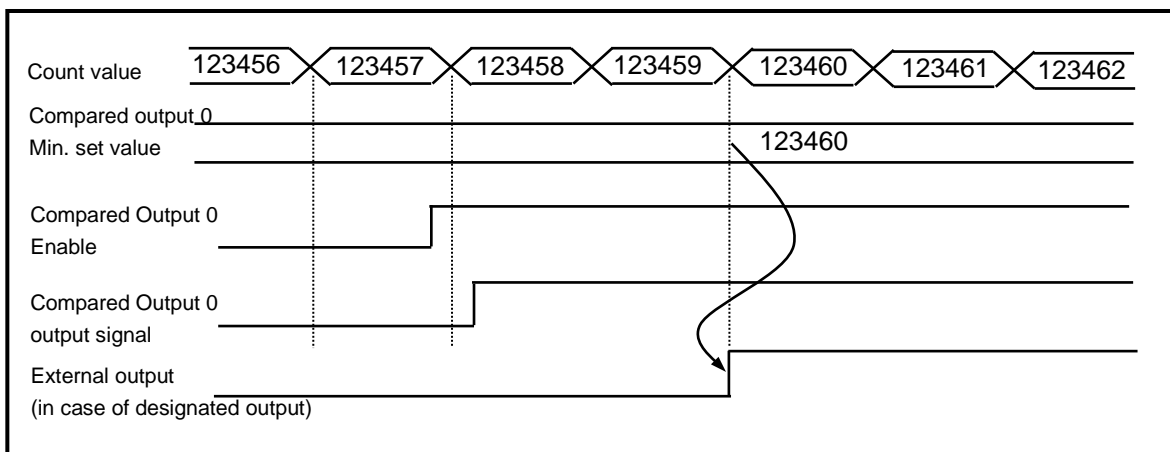

E) Mode 4 (Count value > Compared Output value)

- If present count value is greater than the minimum set value of compared output 0, output is sent out, and if count value decreases to be less than or equal to the minimum set value of compared output 0, output is not sent out.

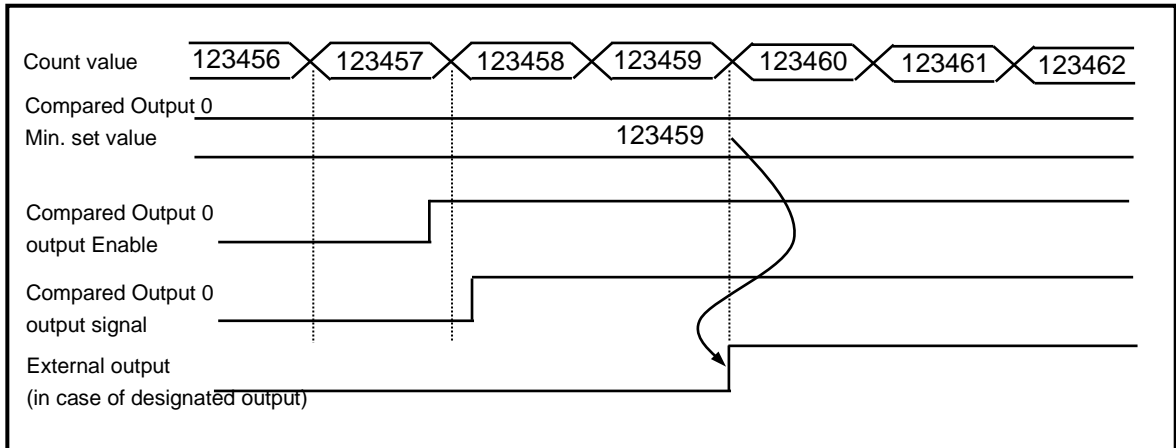

F) Mode 5

(Section comparison: Min. set value of Compared Output 0 ≤ Count value ≤ Max. set value of Compared Output 0)

- If present count value is greater than or equal to the minimum set value of compared output 0 and less than or equal to the maximum set value of compared output 0, output is sent out, and if count value increases/decreases to exceed compared value's range, output is not sent out.

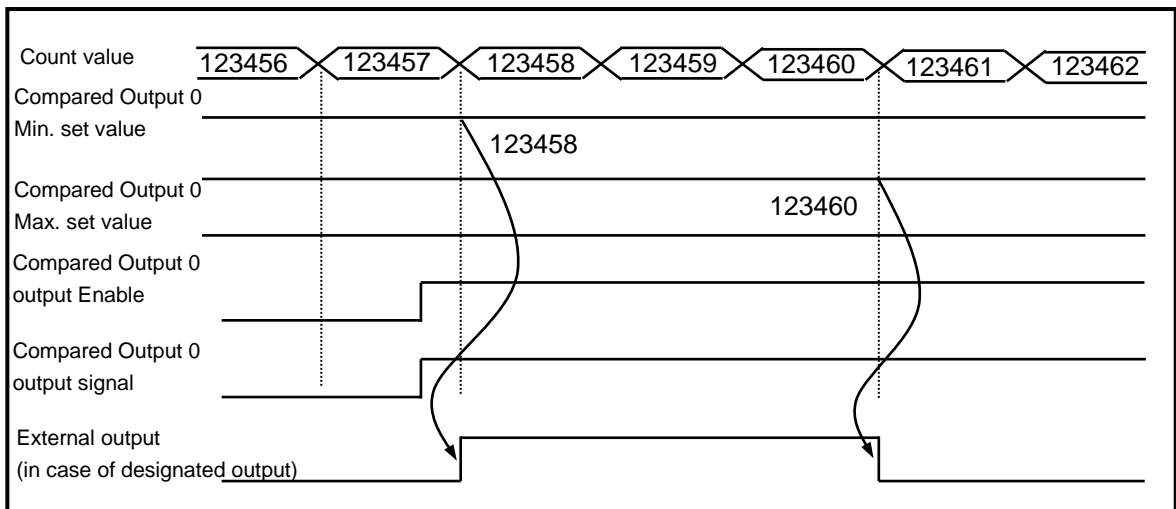

G) Mode 6 (Count value \leq Min. set value of Compared Output 0 or Count value \geq Max. set value of Compared Output 0)

- If present count value is less than or equal to the minimum set value of compared 0 and greater than or equal to the maximum set value of compared 0, output is sent out, and if count value increases/decreases to exceed compared value's range, output is not sent out.

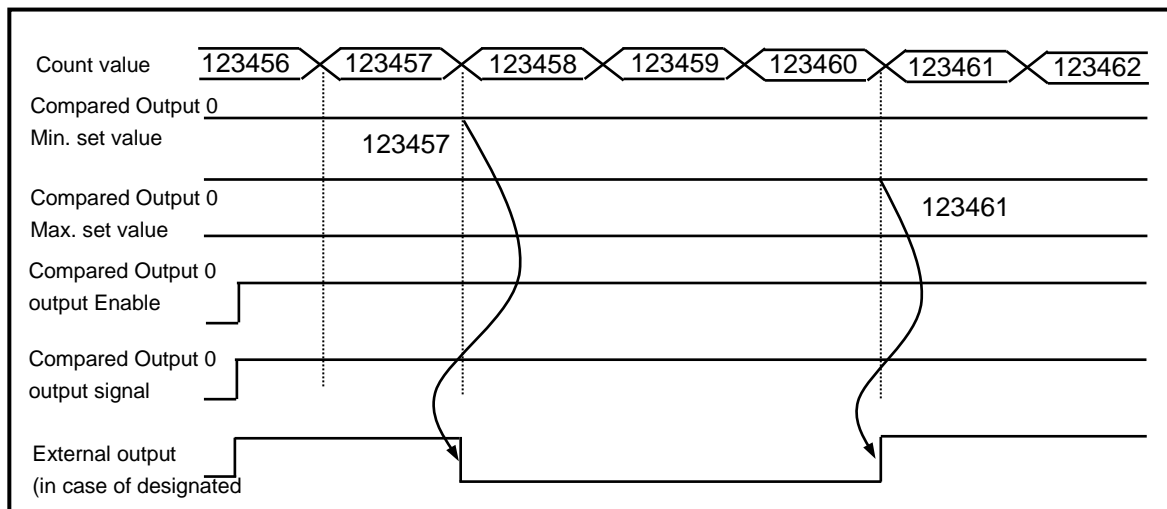

(4) Carry signal

A) Carry signal occurs

- (1) When count range maximum value of 2,147,483,647 is reached during Linear Count.
- (2) When user-defined maximum value of Ring Count changed to the minimum value during Ring Count.

B) Count when Carry Signal occurs

- (1) Count stops if Carry occurs during Linear Count.
- (2) Count does not stop even if Carry occurs during Ring Count.

C) Carry reset

- (1) The Carry generated can be cancelled by Carry/Borrow reset signal On.

Classification	Device area per channel							
	Ch.0	Ch.1	Ch.2	Ch.3	Ch.4	Ch.5	Ch.6	Ch.7
Carry signal	K2610	K2710	K2810	K2910	K21810	K21910	K22010	K22110

(5) Borrow signal

A) Borrow signal occurs

- (1) When count range minimum value of -2,147,483,648 is reached during Linear Count.
- (2) When user-defined minimum value of Ring Count changed to the maximum value during Ring Count.

B) Count when Borrow signal occurs

- (1) Count stops if Borrow occurs during Linear Count.
- (2) Count does not stop even if Borrow occurs during Ring Count.

C) Borrow reset

- (1) The Borrow generated can be cancelled by Carry/Borrow reset signal On.

Classification	Device area per channel							
	Ch.0	Ch.1	Ch.2	Ch.3	Ch.4	Ch.5	Ch.6	Ch.7
Borrow signal	K2611	K2711	K2811	K2911	K21811	K21911	K22011	K22111

(6) Revolution/Unit time

While the Flag about the number of revolution per unit time is On, it counts the number of input pulses for a specified time.

A) Setting

(1) Unit time setting

1) Set the unit time and the number of pulse per 1 revolution.

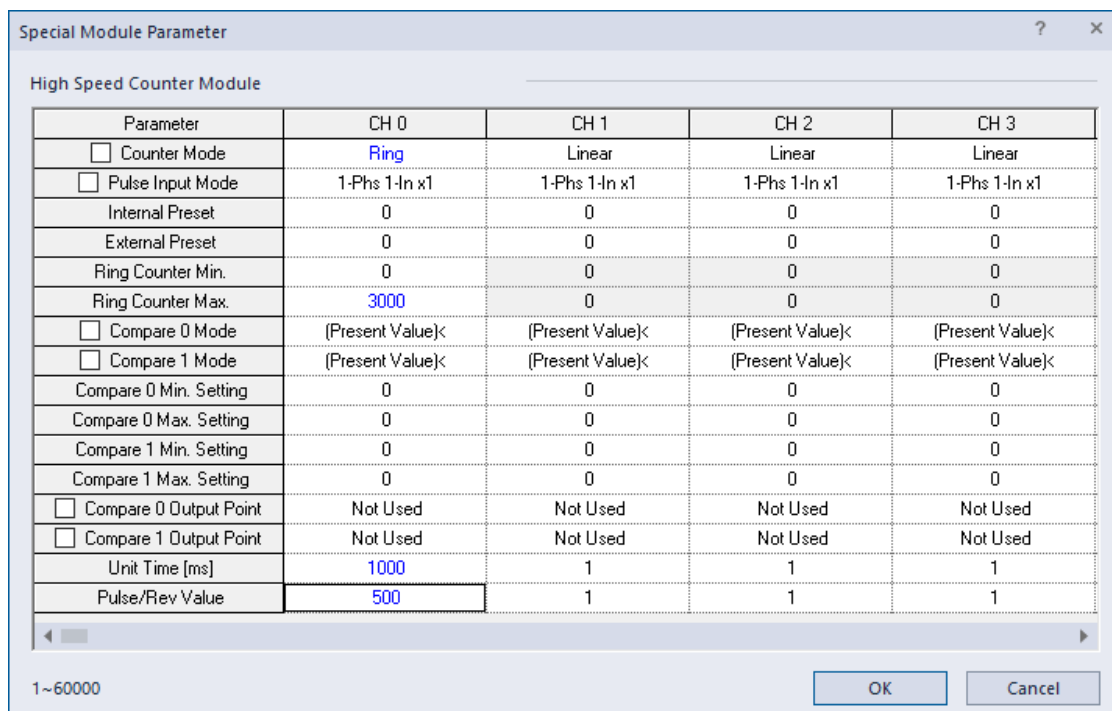

Setting value is saved at the following special K area and user can designate directly.

Class	Device per each channel (Word)								Setting range
	Ch.0	Ch.1	Ch.2	Ch.3	Ch.4	Ch.5	Ch.6	Ch.7	
Unit time	K322	K352	K382	K412	K2242	K2272	K2302	K2332	1~60000ms
Pulse/Rev value	K323	K353	K383	K413	K2243	K2273	K2303	K2333	1~60000

2) In case of using Rev/unit time function, enable the following special K area

Class	Device per each channel (Word)								Operation
	Ch.0	Ch.1	Ch.2	Ch.3	Ch.4	Ch.5	Ch.6	Ch.7	
Rev/unit time command	K2605	K2705	K2805	K2905	K21805	K21905	K22005	K22105	0: disable 1: enable

3) Rev/unit time value is saved at the following special K area.

Class	Device per each channel (Word)								Ref.
	Ch.0	Ch.1	Ch.2	Ch.3	Ch.4	Ch.5	Ch.6	Ch.7	
Rev/unit time	K264	K274	K284	K294	K2184	K2194	K2204	K2214	-

- B) Count function of Revolution/Unit time is used to count the number of pulses for a specified time while auxiliary mode enable signal is On.
- C) With the displayed number of pulses updated for a specified time and the number of pulses per revolution input, Revolution/Unit time can be counted.
- D) Number of Revolution per 1 second is indicated after number of pulse per 1 revolution is set and time is set to 1 second (1000ms). In order to indicate by Revolutions per minute (RPM), the operation is executed in program.
- E) The example that number of pulse per 1 revolution set to '1' and time is set to 1000 ms is as shown below. (Ch0)

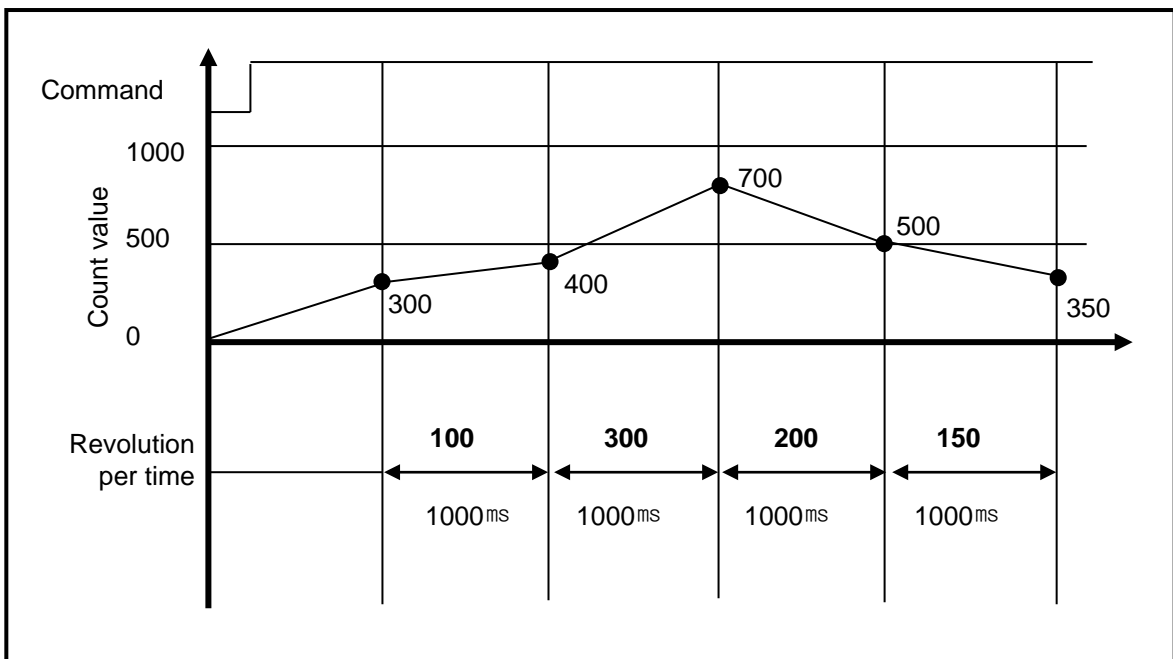

- F) In order to indicate revolution per minute (RPM), the program is as shown below. In case of DMUL operation, RPM value is saved 64 bit in D100~D103. If operated RPM value is used, it can use to Word or Dword type according to system (case of RPM value is small number).

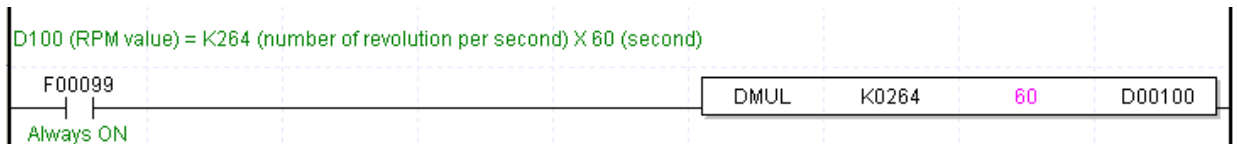

G) The example that number of pulse per 1 revolution set to '10' and time is set to 60,000 ms is as shown below.

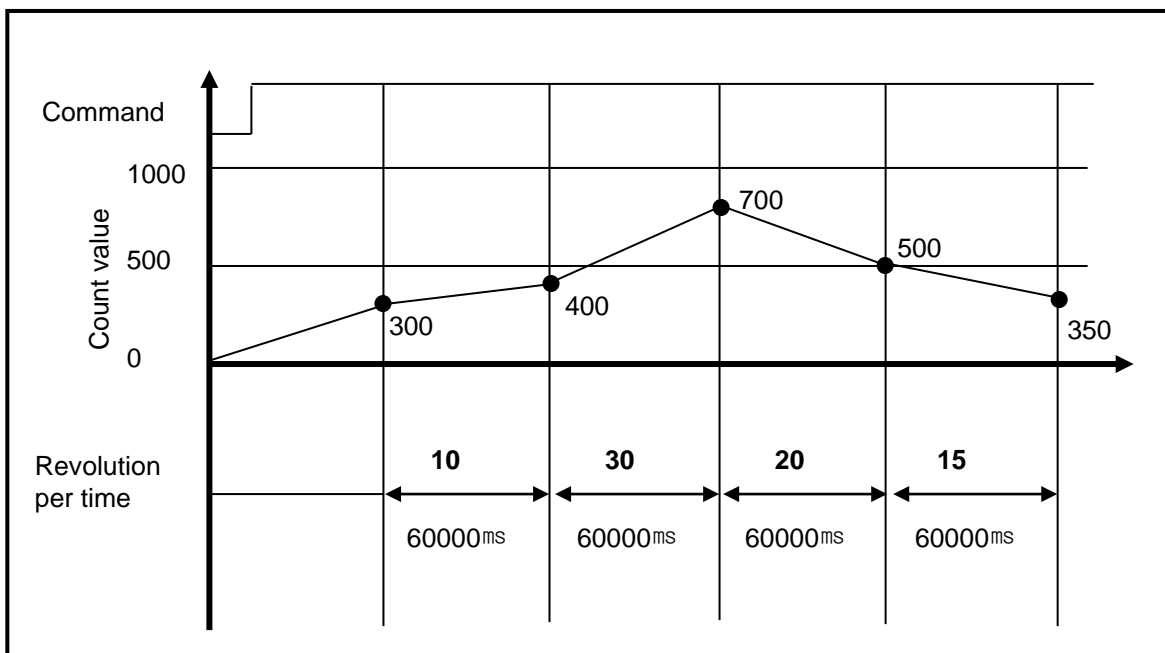

(7) Count latch

- When Count latch signal is On, present count value is latched.
- Setting

If present counter value is to latch, Count Latch function is set 'Use'.

Class	Device area per channel								Operation
	Ch.0	Ch.1	Ch.2	Ch.3	Ch.4	Ch.5	Ch.6	Ch.7	
Count latch command	K2606	K2706	K2806	K2906	K21806	K21906	K22006	K22106	0: disable 1: enable

- Count latch function is operated when Count latch signal is On. Namely, counter value is not cleared when power supply Off =>On and mode change, it is counted from previous value.
- In latch counter function, internal or external preset function has to use for clearing present value.

(8) Preset function

It changes the current value into preset value.

There are two types of preset function, internal preset and external preset. External preset is fixed as input contact point.

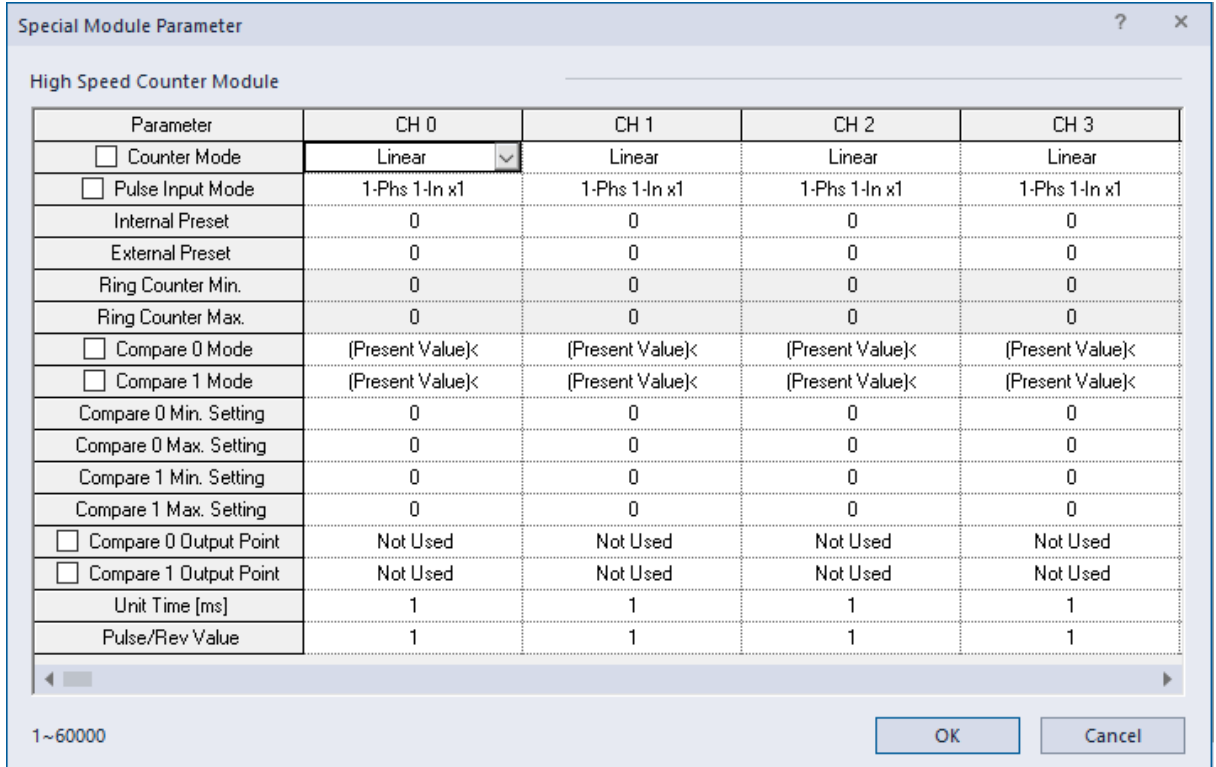

- Preset setting value is saved at the following special K area.

Type	Area per each channel (Double word)								Ref.
	Ch.0	Ch.1	Ch.2	Ch.3	Ch.4	Ch.5	Ch.6	Ch.7	
Internal preset value	K304	K334	K364	K394	K2224	K2254	K2284	K2314	-
External preset value	K306	K336	K366	K396	K2226	K2256	K2286	K2316	-

- Preset command is specified through the following special K area, external preset is used by executing the designated input contact point after allowance bit is on.

Type	Area per each channel (Bit)								Ref.
	Ch.0	Ch.1	Ch.2	Ch.3	Ch.4	Ch.5	Ch.6	Ch.7	
Internal preset command	K2601	K2701	K2801	K2901	K21801	K21901	K22001	K22101	-
External preset allowance	K2602	K2702	K2802	K2902	K21802	K21902	K22002	K22102	-
External preset command	P008	P009	P00A	P00B	P00C	P00D	P00E	P00F	-

8.2 Installation and Wiring

8.2.1 Precaution for wiring

Pay attention to the counteractions against wiring noise especially for High-speed pulse input.

- 1) Surely use twisted pair shielded cable, grounded with 3 class applied.
- 2) Keep away from power cable or I/O line which may cause noise.
- 3) Stabilized power should be used for filter.

- ▶ Connect A-phase only for 1-phase input.
- ▶ Connect A-phase and B-phase for 2-phase input.

8.2.2 Example of wiring

- (1) In case of pulse generator (encoder) is voltage output type

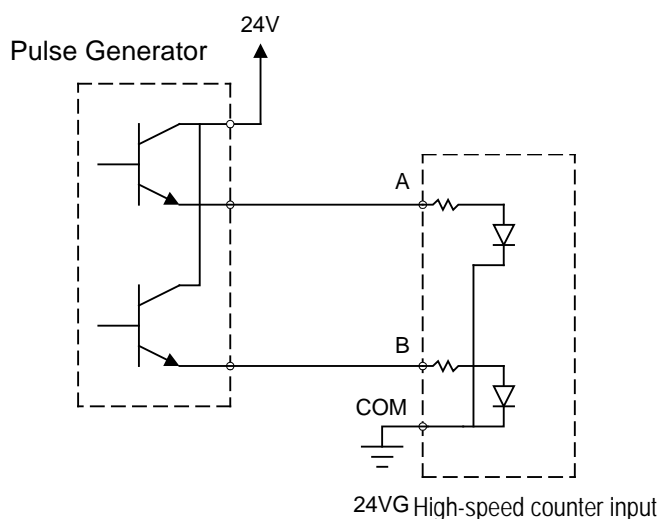

- (2) In case of pulse generator is open collector type

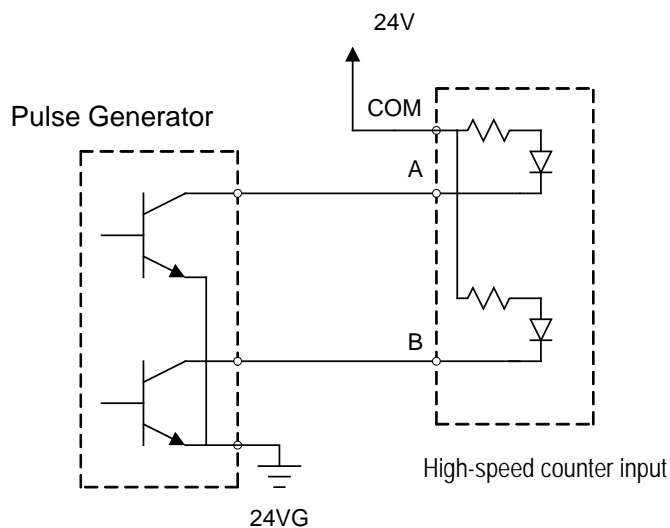

8.3 Internal Memory

8.3.1 Special area for High-speed counter

Parameter and operation command area of built-in high-speed counter use a special K device.

If values set in parameter are changed, it works with the changed values. At the moment, makes sure to use WRT command to save the changed value to flash. If not saved in flash, the changed values with the power off => on and mode changed may not be maintained.

- The following example shows that the internal preset values of CH1 set in parameter are changed by program and saved in flash.
 - Receiving an order command (M000), it moves (MOV) the new internal preset value (5000) to the CH1 present area (K332).
 - To save the changed settings into flash, it uses WRT command. At the moment, slot information is set to '0' in case of built-in function.

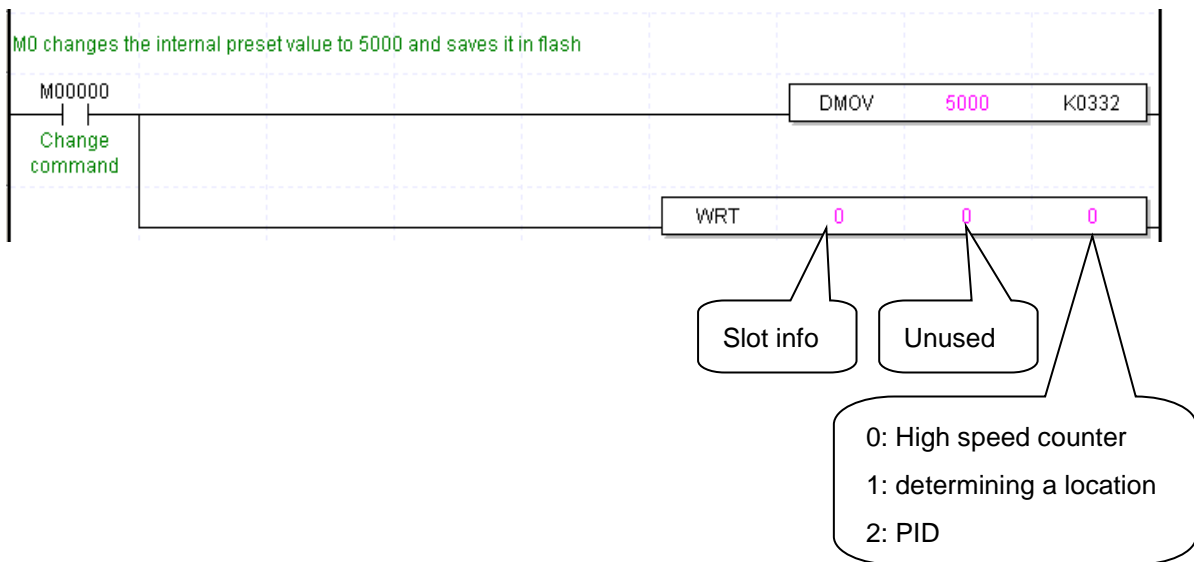

Remark

- (1) In case of saving in flash memory using WRT instruction, processing time of about 200~300ms is required.
- (2) Turning off the PLC power while writing to the flash memory or repetitively using the WRT command may damage the flash memory, so be careful when using it.

(1) "S" type

(a) Parameter setting

Parameter	Description		Device area per channel				Remark
	Value	Setting	Ch 0	Ch 1	Ch 2	Ch 3	
Counter mode	h0000	Linear count	K300	K330	K360	K390	Word
	h0001	Ring count					
Pulse input mode	h0000	1 phase 1 input 1 multiplication	K301	K331	K361	K391	Word
	h0001	1 phase 2 input 1 multiplication					
	h0002	CW / CCW					
	h0003	2 phase 4 multiplication					
Comp. Output mode	h0000	(Magnitude) <	K302	K332	K362	K392	Word
	h0001	(Magnitude) ≤					
	h0002	(Magnitude) =					
	h0003	(Magnitude) ≥					
	h0004	(Magnitude) >					
	h0005	(Range) Include					
	h0006	(Range) Exclude					
Internal preset value setting	-2,147,483,648 ~ 2,147,483,647		K304	K334	K364	K394	DWord
External preset value setting	-2,147,483,648 ~ 2,147,483,647		K306	K336	K366	K396	DWord

Parameter	Description		Device area per channel				Remark
	Value	Setting	Ch 0	Ch 1	Ch 2	Ch 3	
Ring counter Max. value setting	-2,147,483,648 ~ 2,147,483,647		K310	K340	K370	K400	DWord
Comp. Output Min. value setting	-2,147,483,648 ~ 2,147,483,647		K312	K342	K372	K402	DWord
Comp. output Max. value setting	-2,147,483,648 ~ 2,147,483,647		K314	K344	K374	K404	DWord
Comp. output point designation	HFFFF	No use	K320	K350	K380	K410	Word
	h0000	P0020					
	h0001	P0021					
	h0002	P0022					
	h0003	P0023					
	h0004	P0024					
	h0005	P0025					
	h0006	P0026					
h0007	P0027						
Unit time [ms]	1 ~ 60,000		K322	K352	K382	K412	DWord
Pulse/Rev.value	1 ~ 60,000		K323	K353	K383	K413	DWord

(b) Operation command

Parameter	Device area per channel			
	Ch 0	Ch 1	Ch 2	Ch 3
Counter enabling	K2600	K2700	K2800	K2900
Internal preset designation of counter	K2601	K2701	K2801	K2901
External preset enabling of counter	K2602	K2702	K2802	K2902
Designation of decremental counter	K2603	K2703	K2803	K2903
Comp. output enabling	K2604	K2704	K2804	K2904
Enabling of revolution time per unit time	K2605	K2705	K2805	K2905
Designation of latch counter	K2606	K2706	K2806	K2906
Carry signal (Bit)	K2610	K2710	K2810	K2910
Borrow signal	K2611	K2711	K2811	K2911
Comp. output signal	K2612	K2712	K2812	K2912

(c) Area of monitoring

Parameter	Device area per channel				Remark
	Ch 0	Ch 1	Ch 2	Ch 3	
Current counter value	K262	K272	K282	K292	DWord
Revolution time per unit time	K264	K274	K284	K294	DWord

(2) "H" type

(a) Parameter setting

Parameter	Description		Device area per channel				Remark
	Value	Setting	Ch 0	Ch 1	Ch 2	Ch 3	
			Ch 4	Ch 5	Ch 6	Ch 7	
Counter mode	h0000	Linear count	K300	K330	K360	K390	Word
	h0001	Ring count	K2220	K2250	K2280	K2310	
Pulse input mode setting	h0000	1 phase 1 input 1 multiplication	K301	K331	K361	K391	Word
	h0001	1 phase 2 input 1 multiplication					
	h0002	CW / CCW	K2221	K2251	K2281	K2311	Word
	h0003	2 phase 4 multiplication					
Comp. Output 0 mode setting	h0000	(Magnitude) <	K302	K332	K362	K392	Word
	h0001	(Magnitude) ≤					
	h0002	(Magnitude) =					
	h0003	(Magnitude) ≥	K2222	K2252	K2282	K2312	
	h0004	(Magnitude) >					
	h0005	(Range) Include					
	h0006	(Range) Exclude					
Comp. Output 1 mode setting	h0000	(Magnitude) <	K303	K333	K363	K393	Word
	h0001	(Magnitude) ≤					
	h0002	(Magnitude) =					
	h0003	(Magnitude) ≥	K2223	K2253	K2283	K2313	
	h0004	(Magnitude) >					
	h0005	(Range) Include					
	h0006	(Range) Exclude					
Internal preset value setting	-2,147,483,648 ~ 2,147,483,647		K304	K334	K364	K394	DWord
			K2224	K2254	K2284	K2314	
External preset value setting	-2,147,483,648 ~ 2,147,483,647		K306	K336	K366	K396	DWord
			K2226	K2256	K2286	K2316	

Parameter	Description		Device area per channel				Remark
	Value	Setting	Ch 0	Ch 1	Ch 2	Ch 3	
			Ch 4	Ch 5	Ch 6	Ch 7	
Ring counter min. value setting	-2,147,483,648 ~ 2,147,483,645		K308	K338	K368	K398	DWord
			K2228	K2258	K2288	K2318	
Ring counter max. value setting	-2,147,483,646 2,147,483,647		K310	K340	K370	K400	DWord
			K2230	K2260	K2290	K2320	
Comp. output min. value setting	-2,147,483,648 ~ 2,147,483,647		K312	K342	K372	K402	DWord
			K2232	K2262	K2292	K2322	
Comp. output max. value setting	-2,147,483,648 ~ 2,147,483,647		K314	K344	K374	K404	DWord
			K2234	K2264	K2294	K2324	
Comp. output 0 point designation	HFFFF	No use	K320	K350	K380	K410	Word
	h0000	P0020					
	h0001	P0021					
	h0002	P0022					
	h0003	P0023					
	h0004	P0024					
	h0005	P0025					
	h0006	P0026					
	h0007	P0027					
	h0008	P0028	K2240	K2270	K2300	K2330	
	h0009	P0029					
	h000A	P002A					
	h000B	P002B					
	h000C	P002C					
	h000D	P002D					
	h000E	P002E					
h000F	P002F						

Parameter	Description		Device area per channel				Remark
	Value	Setting	Ch 0	Ch 1	Ch 2	Ch 3	
			Ch 4	Ch 5	Ch 6	Ch 7	
Comp. output 1 point designation	HFFFF	No use	K321	K351	K381	K411	Word
	h0000	P0020					
	h0001	P0021					
	h0002	P0022					
	h0003	P0023					
	h0004	P0024					
	h0005	P0025					
	h0006	P0026					
	h0007	P0027					
	h0008	P0028	K2241	K2271	K2301	K2331	
	h0009	P0029					
	h000A	P002A					
	h000B	P002B					
	h000C	P002C					
	h000D	P002D					
	h000E	P002E					
h000F	P002F						
Unit time [ms]	1 ~ 60,000 ms		K322	K352	K382	K412	Word
			K2242	K2272	K2302	K2332	
Pulse/Rev.value	1 ~ 60,000		K323	K353	K383	K413	Word
			K2243	K2273	K2303	K2333	

(b) Operation command

Parameter	Device area per channel							
	Ch 0	Ch 1	Ch 2	Ch 3	Ch 4	Ch 5	Ch 6	Ch 7
Counter enabling	K2600	K2700	K2800	K2900	K21800	K21900	K22000	K22100
Internal preset designation of counter	K2601	K2701	K2801	K2901	K21801	K21901	K22001	K22101
External preset enabling of counter	K2602	K2702	K2802	K2902	K21802	K21902	K22002	K22102
Designation of decremental counter	K2603	K2703	K2803	K2903	K21803	K21903	K22003	K22103
Comp. output 0 enabling	K2604	K2704	K2804	K2904	K21804	K21904	K22004	K22104
Comp. output 1 enabling	K2607	K2707	K2807	K2907	K21807	K21907	K22007	K22107
Enabling of revolution time per unit time	K2605	K2705	K2805	K2905	K21805	K21905	K22005	K22105
Designation of latch counter	K2606	K2706	K2806	K2906	K21806	K21906	K22006	K22100
Carry signal (Bit)	K2610	K2710	K2810	K29100	K21810	K21910	K22010	K22110
Borrow signal	K2611	K2711	K2811	K29101	K21811	K21911	K22011	K22111
Comp. output 0 signal	K2612	K2712	K2812	K29102	K21812	K21912	K22012	K22112
Comp. output 1 signal	K2613	K2713	K2813	K29103	K21813	K21913	K22013	K22113

(c) Area of monitoring

Parameter	Device area per channel							
	Ch 0	Ch 1	Ch 2	Ch 3	Ch 4	Ch 5	Ch 6	Ch 7
Current counter value	K262	K272	K282	K292	K2182	K2192	K2202	K2212
Revolution per unit time	K264	K274	K284	K294	K2184	K2194	K2204	K2214

8.3.2 Error code

It describes errors of the built-in high-speed counter.

- Error occurred is saved in the following area.

Category	Device area per channel								Remark
	Ch0	Ch1	Ch2	Ch3	Ch4	Ch5	Ch6	Ch7	
Error code	K266	K276	K286	K296	K2186	K2196	K2206	K2216	Word

- Error codes and descriptions

Error code (Decimal)	Description	Remark
20	Counter type is set out of range	
21	Pulse input type is set out of range	
22	Requesting #1(3,5,7)channel Run during the 2-phase operation of #0(2,4,6) * During #0(2,4,6) channel 2-phase operation, using #1(3,5,7)channel is not possible.	
23	Compared output type setting is set out of range.	
25	Internal preset value is set out of counter range	
26	External present value is set out of counter range	
27	Ring counter setting is set out of range * Note ring counter setting should be 2 and more.	
28	Compared output min. value is set out of permissible max. input range	
29	Compared output max. value is set out of permissible max. input range	
30	Error of Compared output min. value>Compared output max. value	
31	Output point designation value of Compared output is set out of range	
34	Set value of Unit time is out of the range	
35	Pulse value per 1 revolution is set out of range	
36	Compared output min. value is set out of permissible max. input range (Compared output 1)	"H" type
37	Compared output max. value is set out of permissible max. input range (Compared output 1)	"H" type
38	Error of Compared output min. value>Compared output max. value (Compared output 1)	"H" type
39	Output point designation value of Compared output is set out of range (Compared output 1)	"H" type

Remark

- If two and more errors occur, the module saves the latter error code and removes the former one.

8.4 Examples: Using High-speed Counter

It describes examples of using high-speed counter.

1) Setting high-speed counter parameter

How to set types of parameters to operate a high-speed counter is described as follows.

A) Set 『Internal Parameters』 in the basic project window.

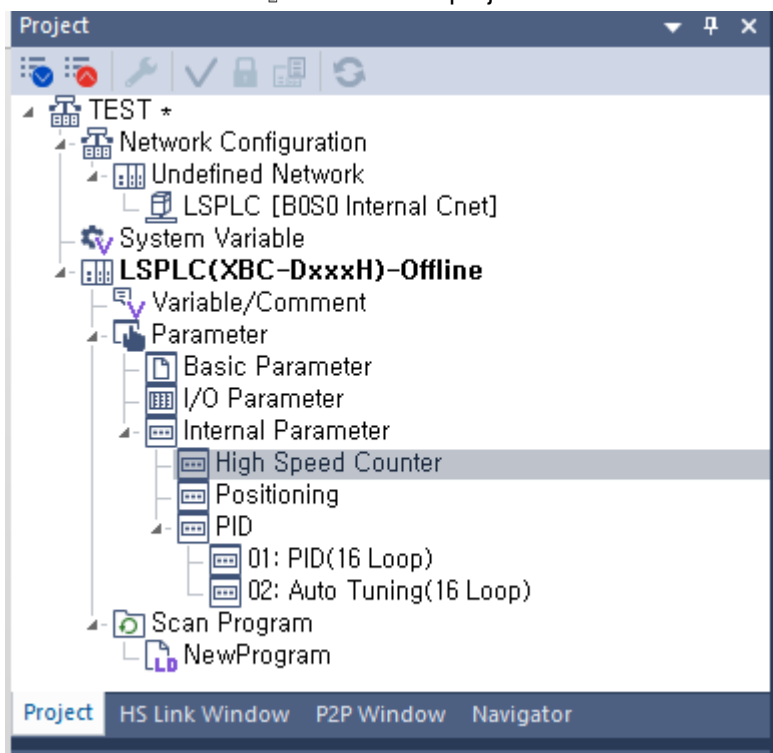

B) Selecting high-speed counter opens a window to set high-speed counter parameters as follows.

For details regarding each parameter setting, refer to 8.1~8.3.

(Every parameter settings are saved in the special K device area.)

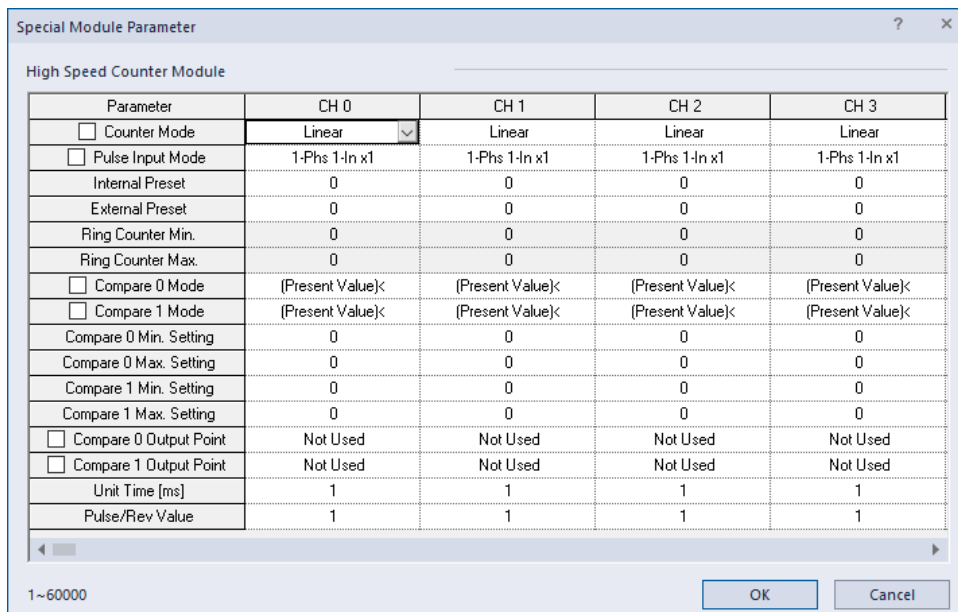

C) Turn 'ON' the high-speed counter Enable signal (CH0:K2600) in the program.

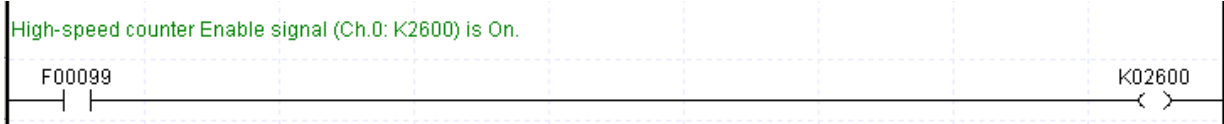

D) To use additional functions of the high-speed counter, you need to turn on the flag allowing an operation command.

* Refer to 2. Operation Command, <8.3.1 Special K Area for High-speed Counter>

For instance, turn on 2605 bit if among additional functions, rotation number function is used.

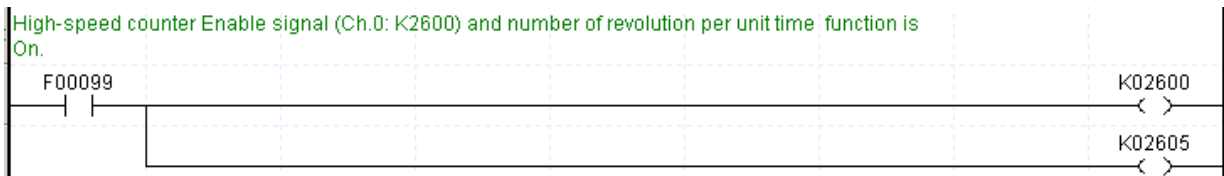

E) Upon the setting, download program and parameter to PLC.

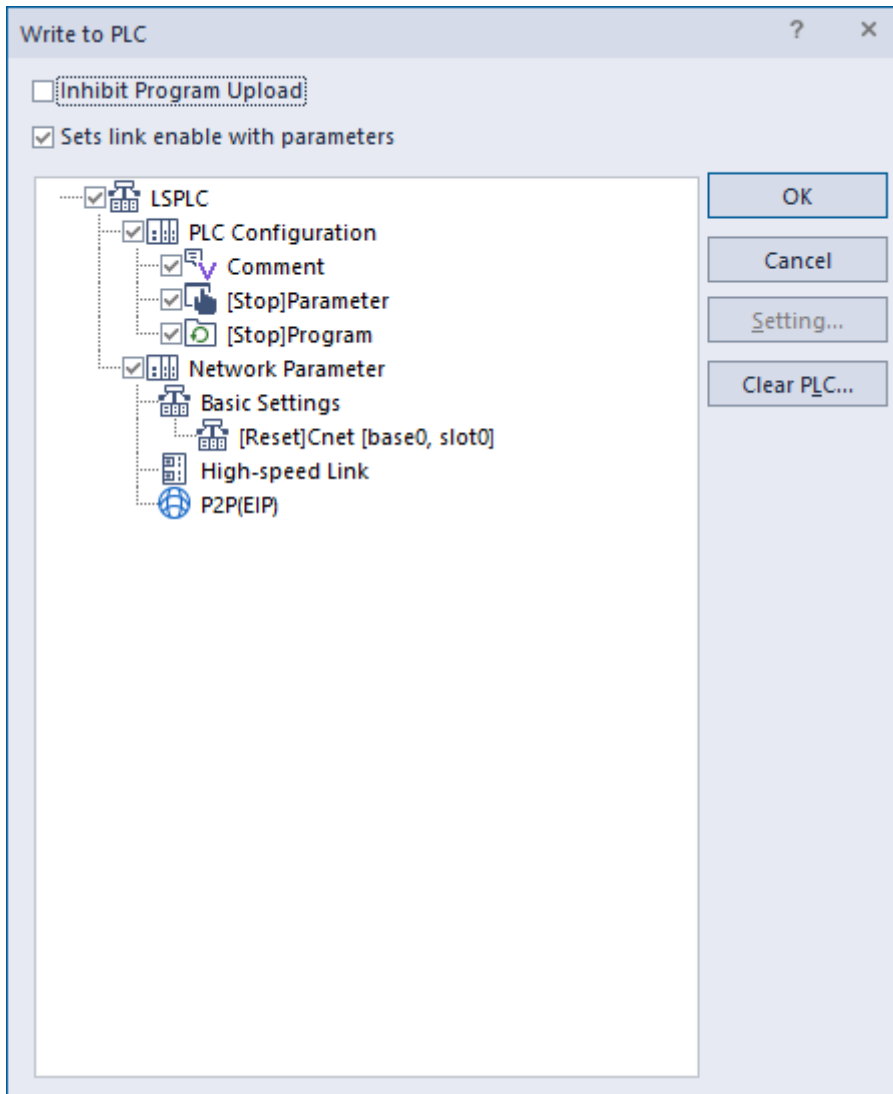

2) Monitoring and setting command

Monitoring and command setting of high-speed counter are described as follows.

A) If starting a monitor and clicking a Special Module Monitor, the following window is opened.

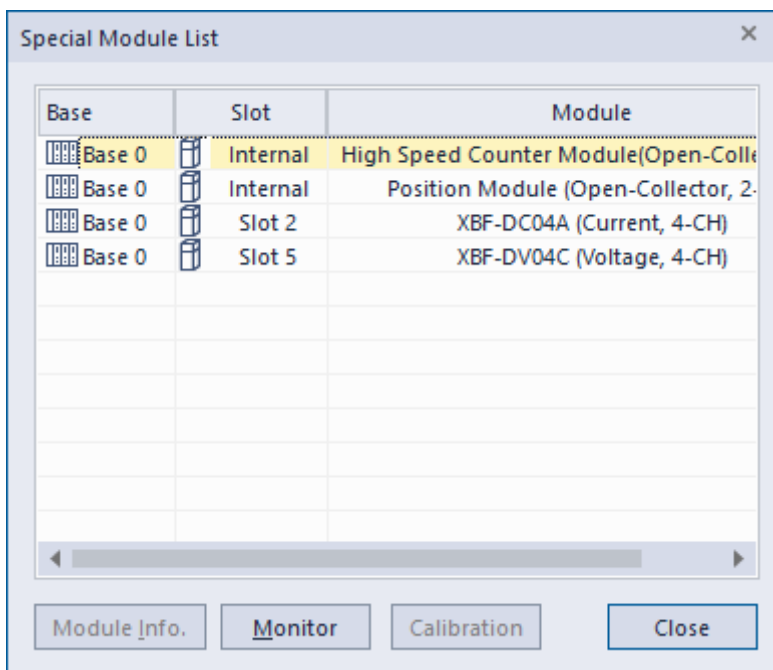
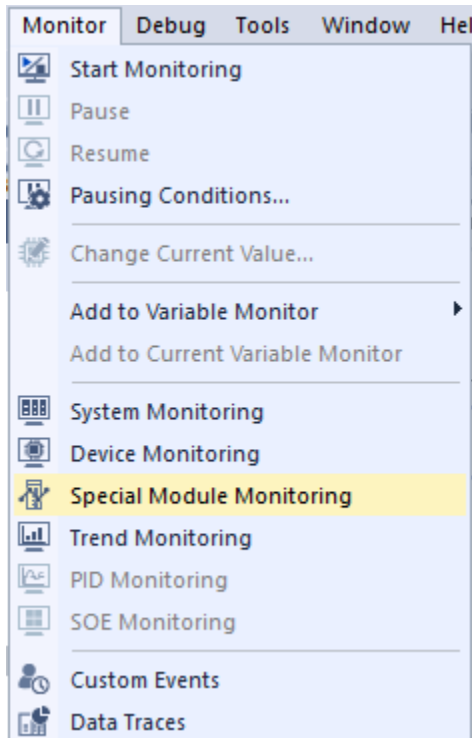

B) Clicking 『Monitor』 shows monitor and test window of high-speed counter.

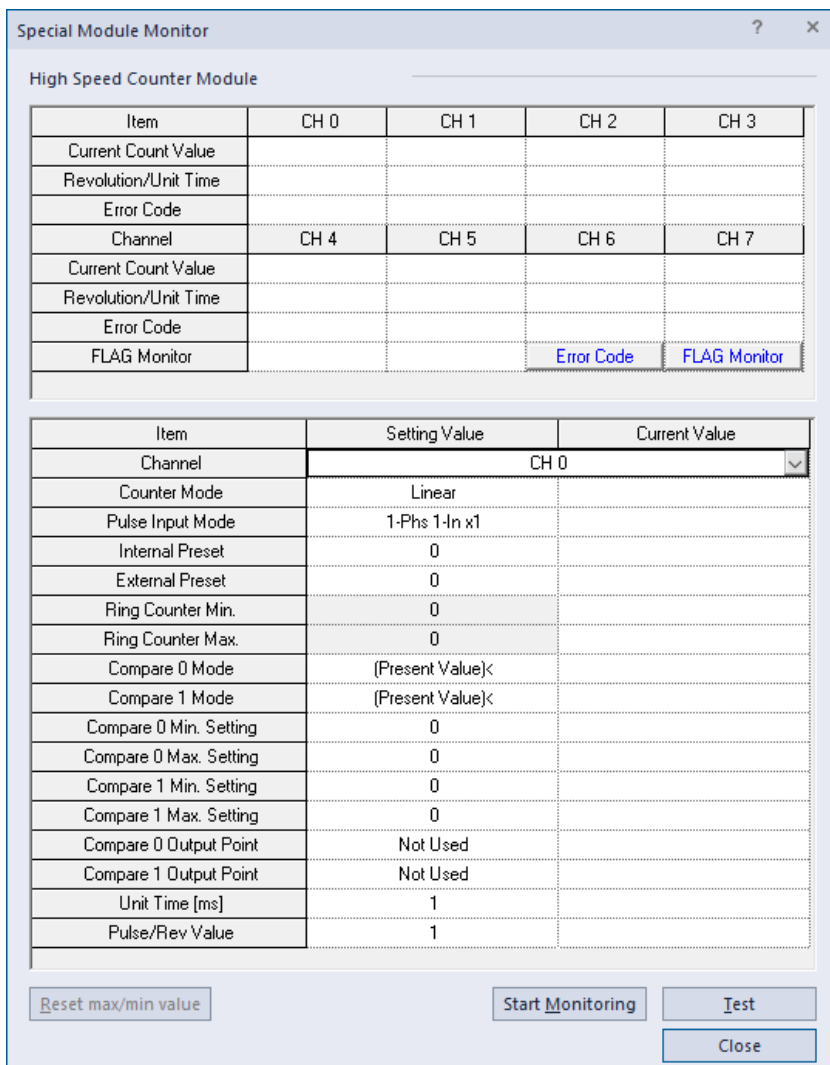

Item	Description
FLAG Monitor	Show flag monitoring and command window of high-speed counter
Start Monitoring	Start monitoring each item (special K device area monitor).
Test	Write each item setting to PLC. (Write the setting to special K device)
Close	Close monitor

- C) Clicking 『Start Monitoring』 shows the high-speed counter monitor display, in which you may set each parameter. At this moment, if any, changed values are not saved if power off=> on or mode is changed.

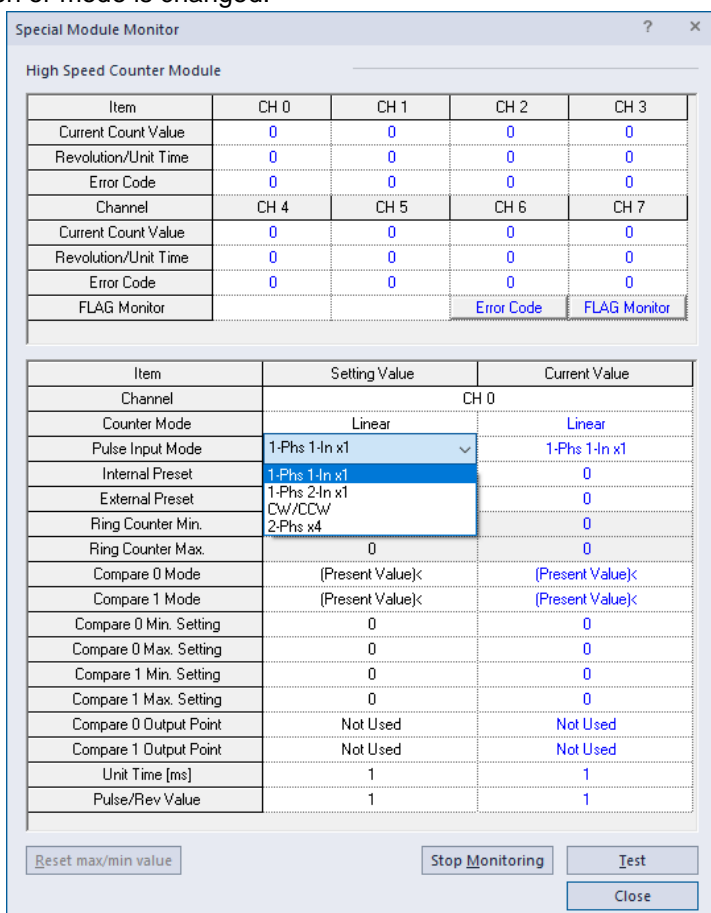

- D) Clicking 『FLAG Monitor』 shows the monitor of each flag in high-speed counter, in which you may direct operation commands by flags (clicking commands reverse turn).

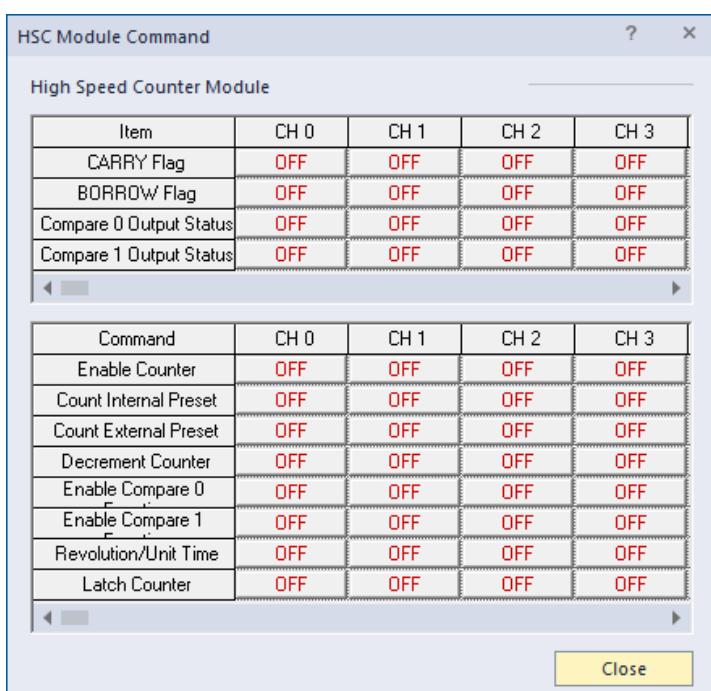

Chapter 9 Installation and Wiring

9.1 Safety Instruction



Danger

- ▶ Please design protection circuit at the external of PLC for entire system to operate safely because an abnormal output or an malfunction may cause accident when any error of external power or malfunction of PLC module.
 - (1) It should be installed at the external side of PLC to emergency stop circuit, protection circuit, interlock circuit of opposition action such as forward /reverse operation and interlock circuit for protecting machine damage such as upper/lower limit of positioning.
 - (2) If PLC detects the following error, all operation stops and all output is off.
 - (Available to hold output according to parameter setting)
 - (a) When over current protection equipment or over voltage protection operates
 - (b) When self diagnosis function error such as WDT error in PLC CPU occurs
- ▶ In case of error about IO control part that is not detected by PLC CPU, all output is off.
Design Fail Safe circuit at the external of PLC for machine to operate safely. Refer to 9.1.1 Fail Safe circuit.
 - (1) Because of error of output device, Relay, TR, etc., output may not be normal. About output signal that may cause the heavy accident, design supervisory circuit to external.
- ▶ In case load current more than rating or over current by load short flows continuously, danger of heat, fire may occur so design safety circuit to external such as fuse.
- ▶ Design for external power supply to be done first after PLC power supply is done. If external power supply is done first, it may cause accident by misoutput, misoperation.
- ▶ In case communication error occurs, for operation status of each station, refer to each communication manual.
- ▶ In case of controlling the PLC while peripheral is connected to CPU module, configure the interlock circuit for system to operate safely. During operation, in case of executing program change, operation status change, familiarize the manual and check the safety status. Especially, in case of controlling long distance PLC, user may not response to error of PLC promptly because of communication error or etc.
Limit how to take action in case of data communication error between PLC CPU and external device adding installing interlock circuit at the PLC program.



Danger

- ▶ Don't close the control line or communication cable to main circuit or power line. Distance should be more than 100mm. It may cause malfunction by noise.
- ▶ In case of controlling lamp load, heater, solenoid valve, etc. in case of Off -> On, large current (10 times of normal current) may flows, so consider changing the module to module that has margin at rated current.
- ▶ Process output may not work properly according to difference of delay of PLC main power and external power for process (especially DC in case of PLC power On-Off and of start time.
For example, in case of turning on PLC main power after supplying external power for process, DC output module may malfunction when PLC is on, so configure the circuit to turn on the PLC main power first
Or in case of external power error or PLC error, it may cause the malfunction.
- ▶ Not to lead above error to entire system, part causing breakdown of machine or accident should be configured at the external of PLC

Chapter 9. Installation and Wiring

9.1.1 Fail safe circuit

(1) example of system design (In case of not using ERR contact point of power module)

In case of AC

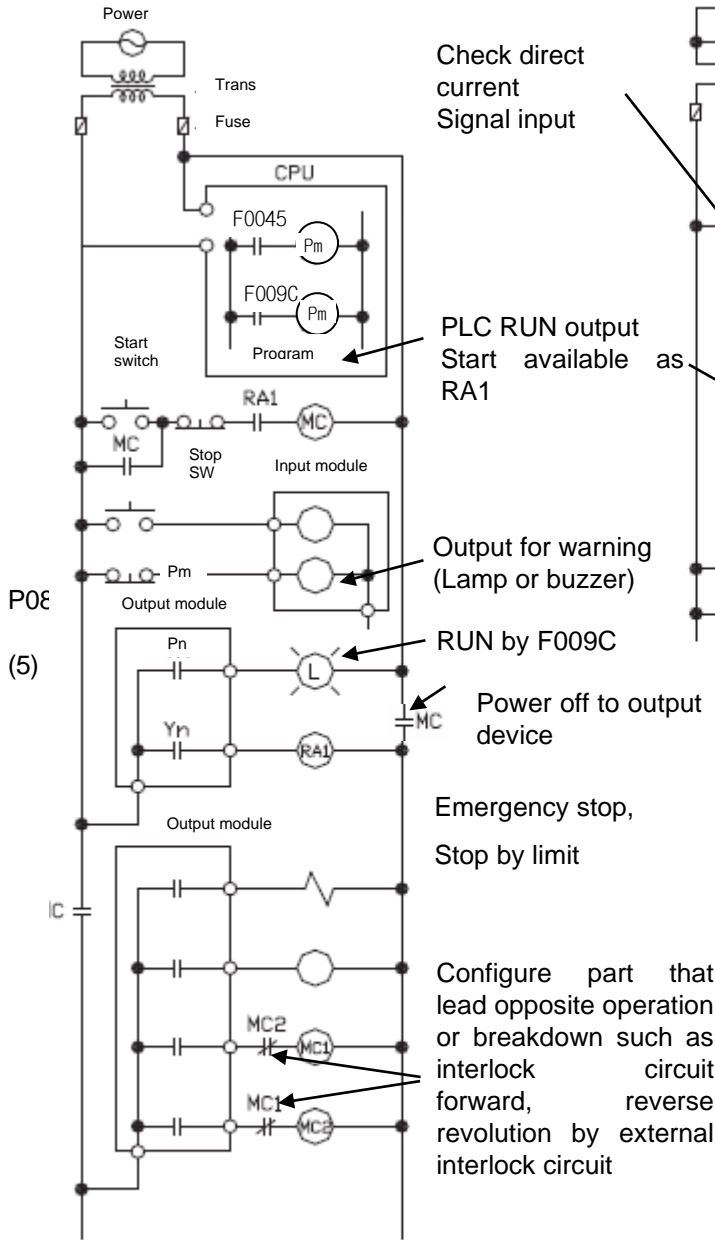

Start sequence of power
In case of AC

- (1) Turn on power
- (2) Run CPU.
- (3) Turn on start switch
- (4) Output device runs by program through magnetic contactor (MC) [On]

In case of AC . DC

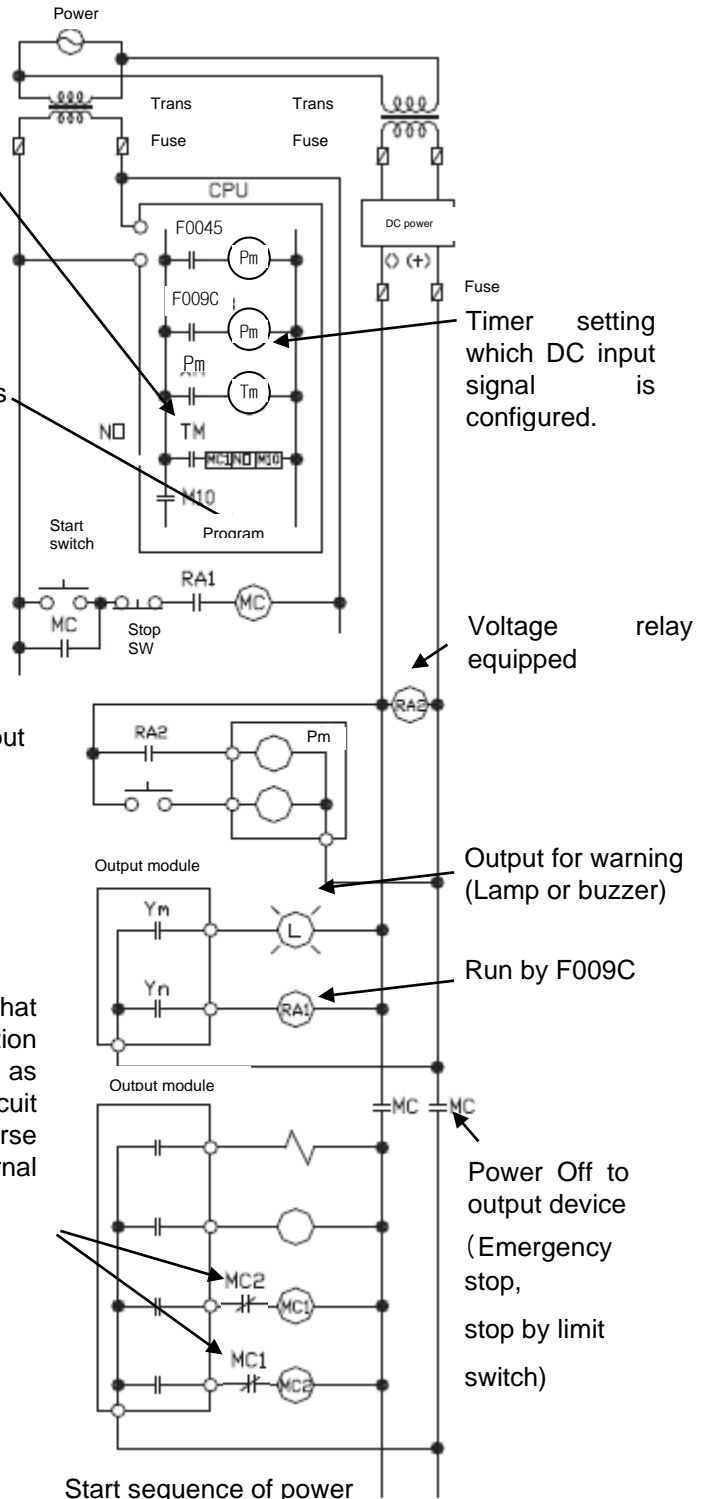

Start sequence of power
In case of AC DC

- Run CPU after power is on
- (1) Turn on RA2 as DC power on
- (2) Turn on timer after DC power is stable.
- (3) Turn on start switch
- (4) Output device runs by program through magnetic contactor (MC) [On]

(2) System design circuit example (In case of using ERR contact point of power module)

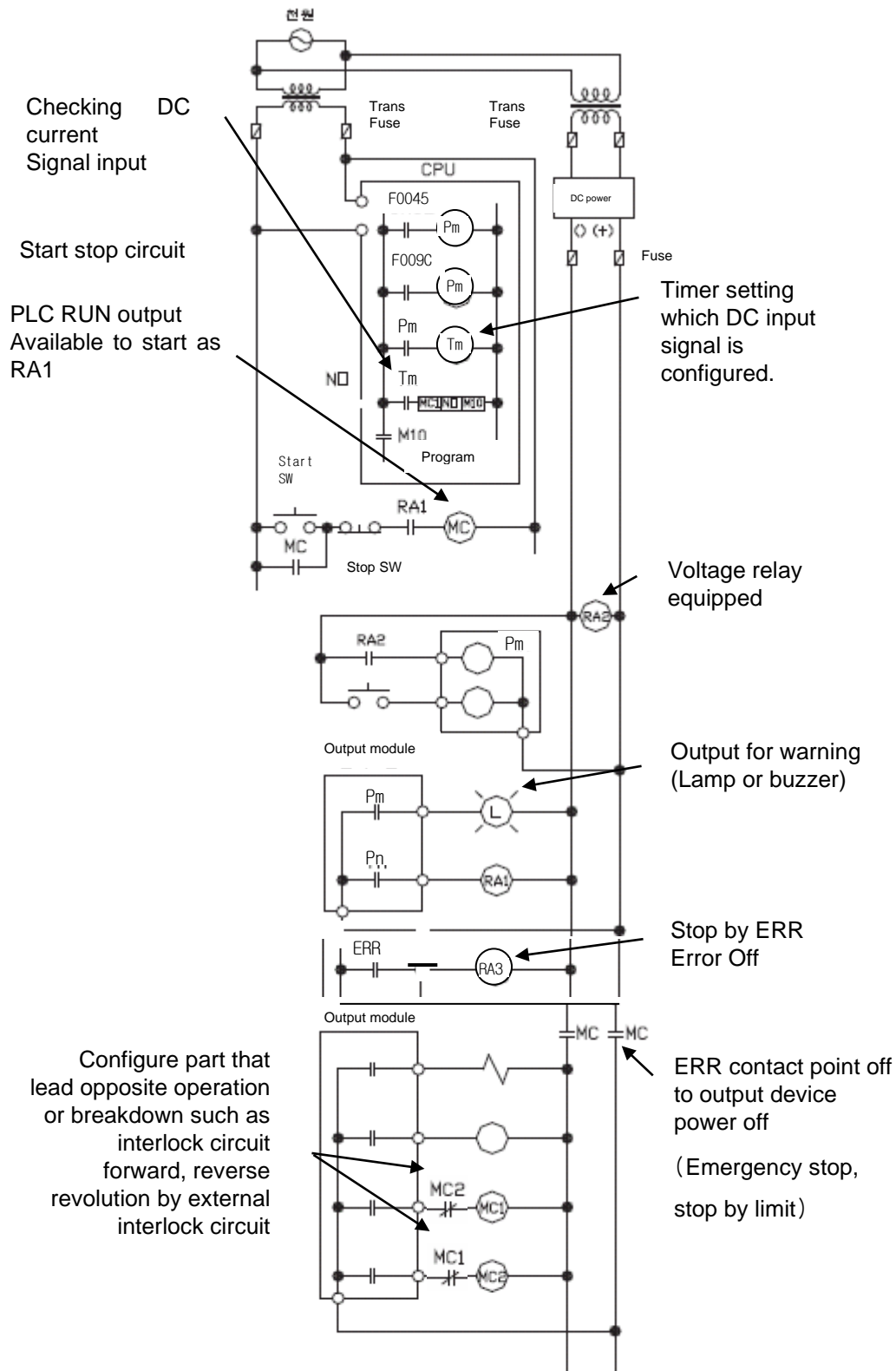

Start sequence of power
In case of AC DC

- (1) Run CPU after turning on power.
- (2) Turn on RA2 with DC power supplied
- (3) Turn on timer after DC power is stable
- (4) Turn on start switch Output device runs by program through magnetic contactor (MC) [On]

Chapter 9. Installation and Wiring

(3) Fail safe countermeasure in case of PLC error

Error of PLC CPU and memory is detected by self diagnosis but in case error occurs in IO control part, etc., CPU can detect the error. At this case, though it is different according to status of error, all contact point is on or off, so safety may not be guaranteed. Though we do our best to our quality as producer, configure safety circuit preparing that error occurs in PLC and it lead to breakdown or accident.

System example

Main unit	Input 16 point	Input 16 point	Input 16 point	Input 16 point	Output 16 point	Output 16 point
-----------	----------------	----------------	----------------	----------------	-----------------	-----------------

Output module for fail safe

Equip output module for fail safe to last slot of system.

[Fail safe circuit example]

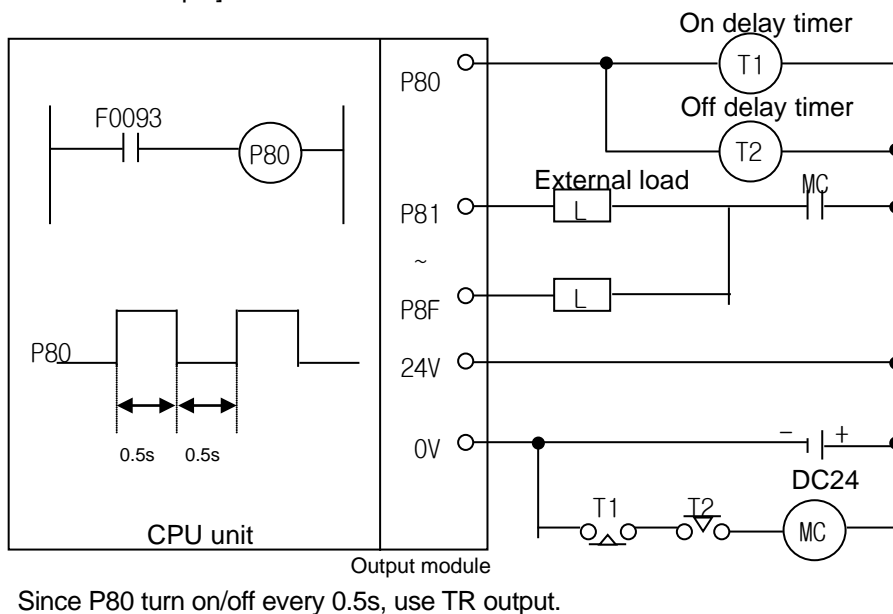

9.1.2 PLC heat calculation

(1) Power consumption of each part

(a) Power consumption of module

The power conversion efficiency of power module is about 70% and the other 30% is gone with heat; 3/7 of the output power is the pure power consumption. Therefore, the calculation is as follows.

- $W_{pw} = 3/7 \{ (I_{5V} \times 5) + (I_{24V} \times 24) \}$ (W)

I_{5V} : power consumption of each module DC5V circuit(internal current consumption)

I_{24V} : the average current consumption of DC24V used for output module
(current consumption of simultaneous On point)

If DC24V is externally supplied or a power module without DC24V is used, it is not applicable.

(b) Sum of DC5V circuit current consumption

The DC5V output circuit power of the power module is the sum of power consumption used by each module.

- $W_{5V} = I_{5V} \times 5$ (W)

(c) DC24V average power consumption(power consumption of simultaneous On point)

The DC24V output circuit's average power of the power module is the sum of power consumption used by each module.

- $W_{24V} = I_{24V} \times 24$ (W)

(d) Average power consumption by output voltage drop of the output module(power consumption of simultaneous On point)

- $W_{out} = I_{out} \times V_{drop} \times \text{output point} \times \text{simultaneous On rate}$ (W)

I_{out} : output current (actually used current) (A)

V_{drop} : voltage drop of each output module (V)

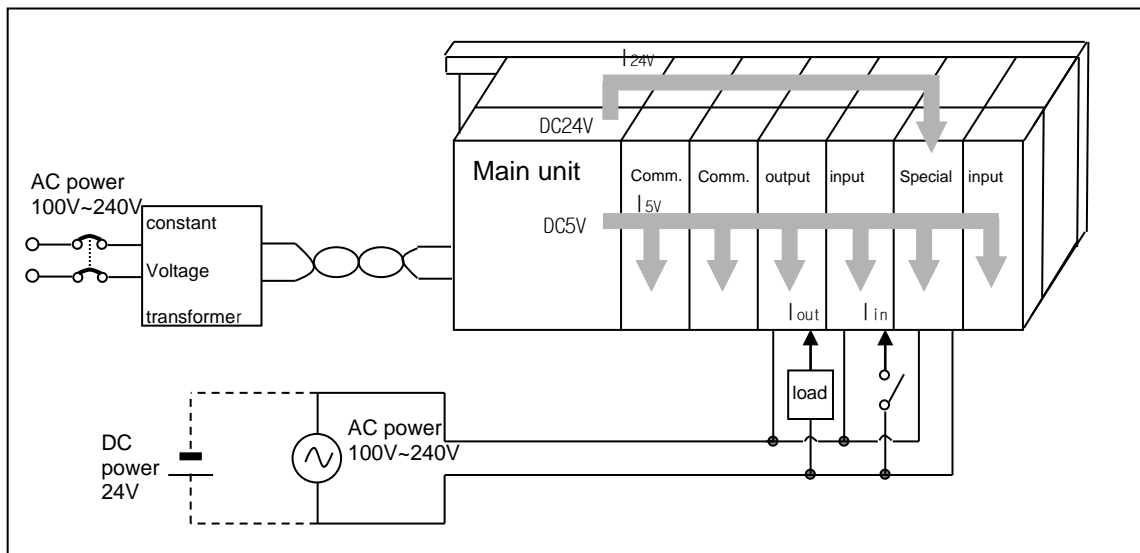

(e) Input average power consumption of input module
(power consumption of simultaneous On point)

- $W_{in} = I_{in} \times E \times \text{input point} \times \text{simultaneous On rate (W)}$
I_{in}: input current (root mean square value in case of AC) (A)
E : input voltage (actually used voltage) (V)

(f) Power consumption of special module power assembly

- $W_s = I_{5V} \times 5 + I_{24V} \times 24 + I_{100V} \times 100 \text{ (W)}$

The sum of power consumption calculated by each block is the power consumption of the entire PLC system.

- $W = W_{PW} + W_{5V} + W_{24V} + W_{out} + W_{in} + W_s \text{ (W)}$

Calculate the heats according to the entire power consumption(W) and review the temperature increase within the control panel.

The calculation of temperature rise within the control panel is displayed as follows.

$$T = W / UA \text{ [}^\circ\text{C]}$$

W : power consumption of the entire PLC system (the above calculated value)

A : surface area of control panel [m²]

U : if equalizing the temperature of the control panel by using a fan and others - - - 6

If the air inside the panel is not ventilated - - - - - 4

If installing the PLC in an air-tight control panel, it needs heat-protective(control) design considering the heat from the PLC as well as other devices. If ventilating by vent or fan, inflow of dust or gas may affect the performance of the PLC system.

9.2 Attachment/Detachment of Modules

9.2.1 Attachment/Detachment of modules

Caution in handling

Use PLC in the range of general specification specified by manual.

In case of using out of range, it may cause electric shock, fire, malfunction, damage of product.

Warning

- ▶ Module must be mounted to hook for fixation properly before its fixation. The module may be damaged from over-applied force. If module is not mounted properly, it may cause malfunction.
- ▶ Do not drop or impact the module case, terminal block connector.
- ▶ Do not separate the PCB from case.

(1) Equipment of module

- Eliminate the extension cover at the upper of module.
- Push the module and connect it in agreement with hook for fixation of four edges and hook for connection at the bottom.
- After connection, get down the hook for fixation at the upper part and lower part and fix it completely.

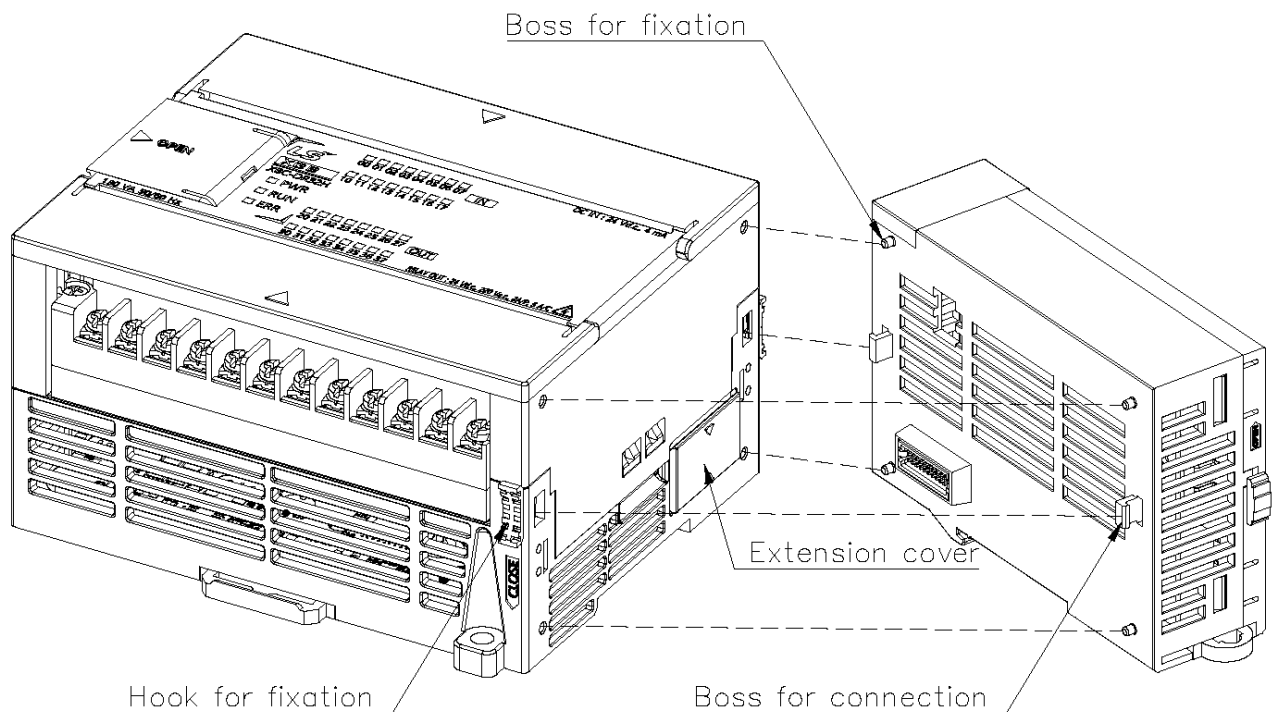

(2) Detachment of module

- Get up the hook for fixation of upper part and lower part and disconnect it.
- Detach the module with two hands. (Don't force over-applied force.)

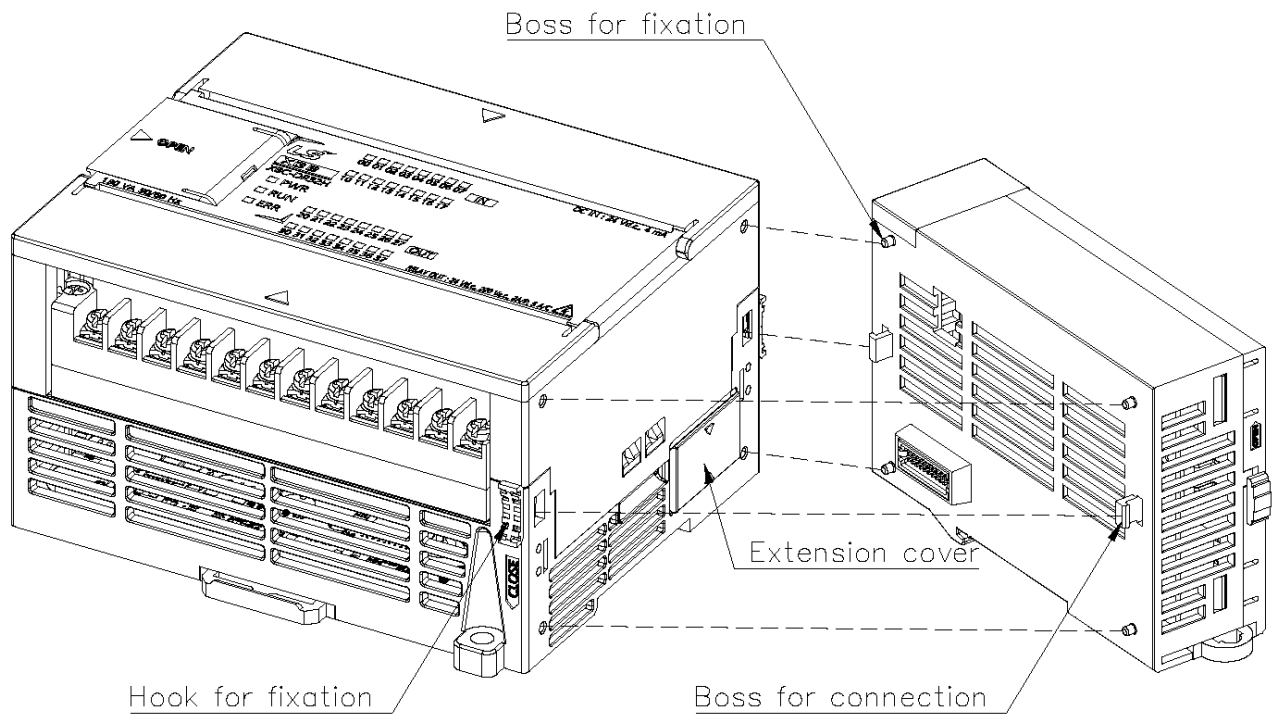

Caution

- ▶ When separating module, don't force over-applied power. If so, hook may be damaged.

(3) Installation of module

XGB PLC main unit and expansion unit are having the hook for DIN rail (rail width 35mm).
So they can be installed at DIN rail.

(a) In case of installing at DIN rail

- Pull out the hook for DIN rail in the bottom of module and install the module at DIN rail.
- After installing the module at DIN rail, push the hook and fix the module at DIN rail.

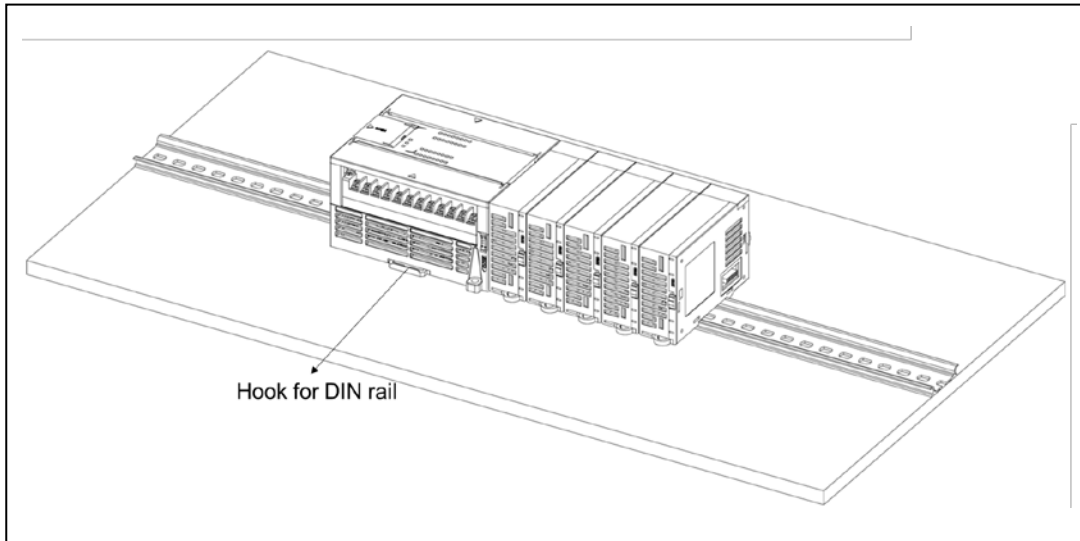

(b) In case of installing at the panel

- You can install the XGB compact type main unit at the panel directly by using screw hole.
- When installing the product at the panel directly, use M4 type screw

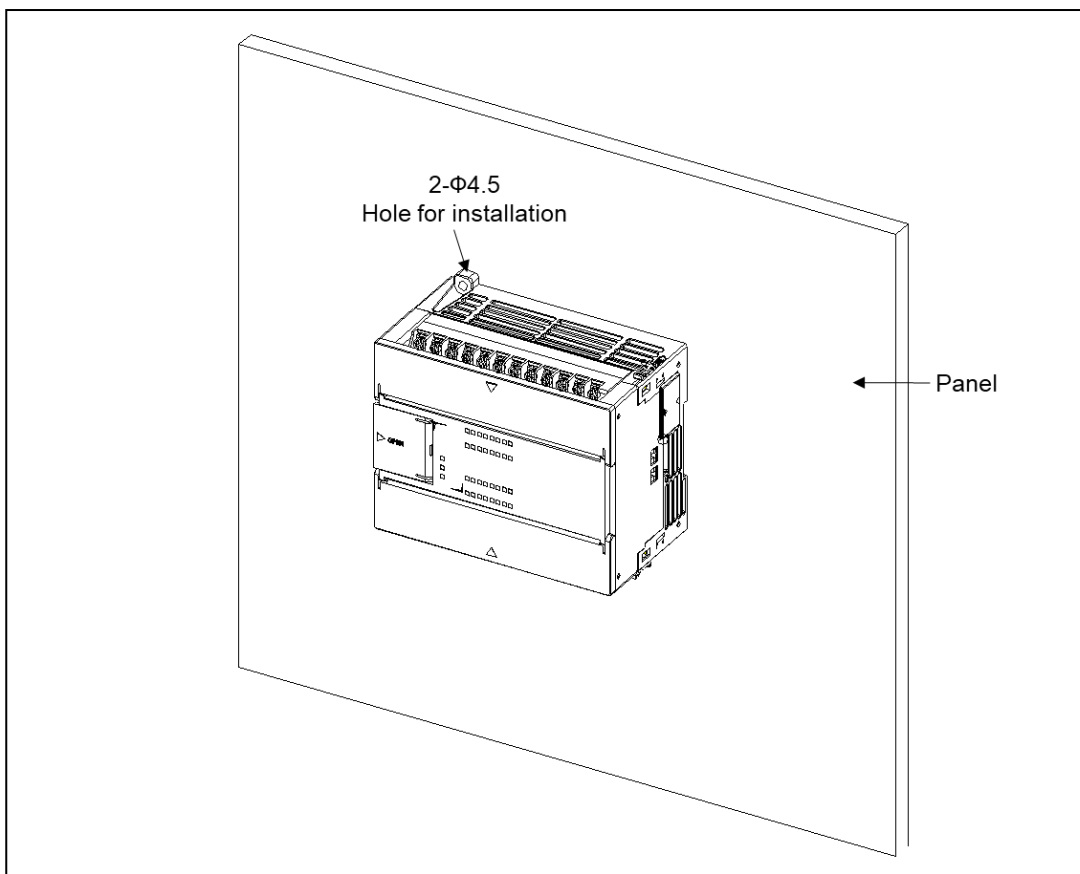

Chapter 9. Installation and Wiring

(4) Module equipment location

Keep the following distance between module and structure or part for well ventilation and easy detachment and attachment.

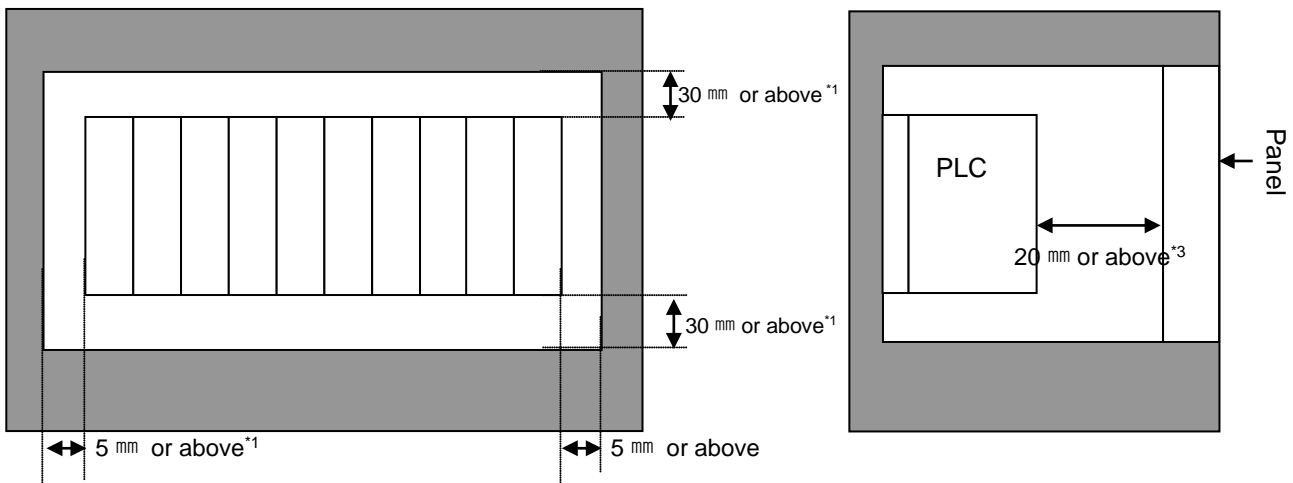

*1 : In case height of wiring duct is less than 50 mm (except this 40mm or above)

*2 : In case of equipping cable without removing near module, 20mm or above

*3 : In case of connector type, 80mm or above

(5) Module equipment direction

(a) For easy ventilation, install like the following figure.

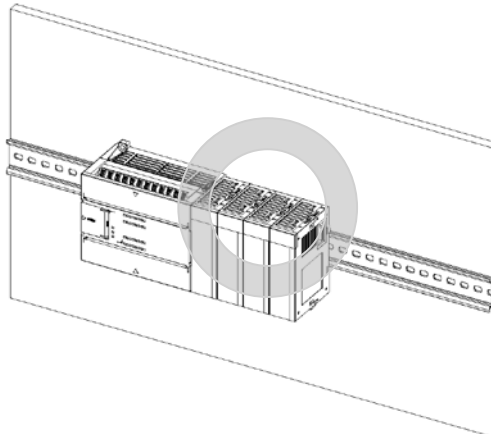

(b) Don't install like the following figure

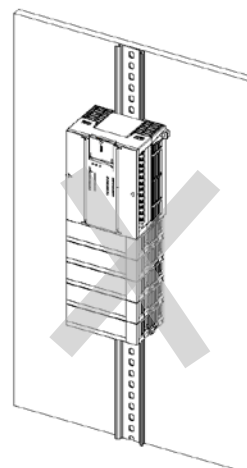
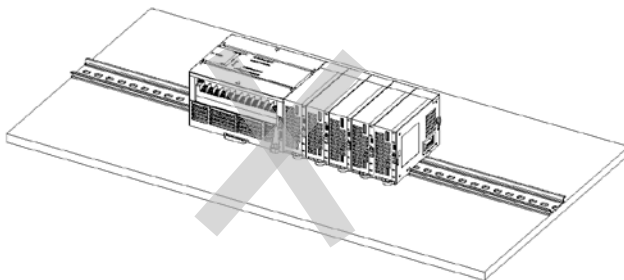

(6) Distance with other device

To avoid radiation noise or heat, keep the distance between PLC and device (connector and relay) as far as the following figure.

Device installed in front of PLC: 100 mm or above

Device installed beside PLC: 50 mm or above

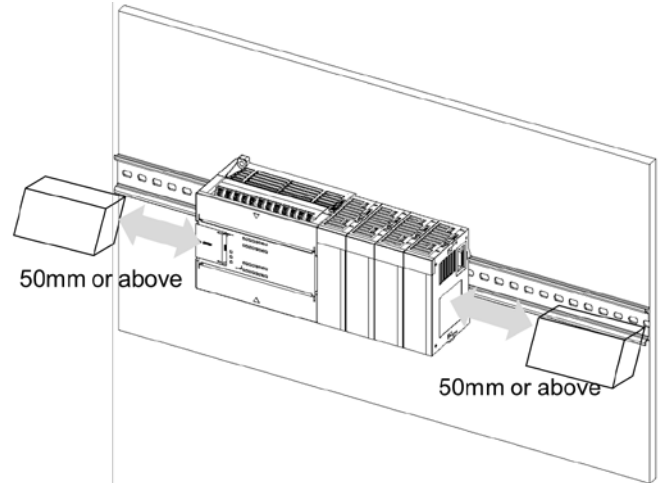
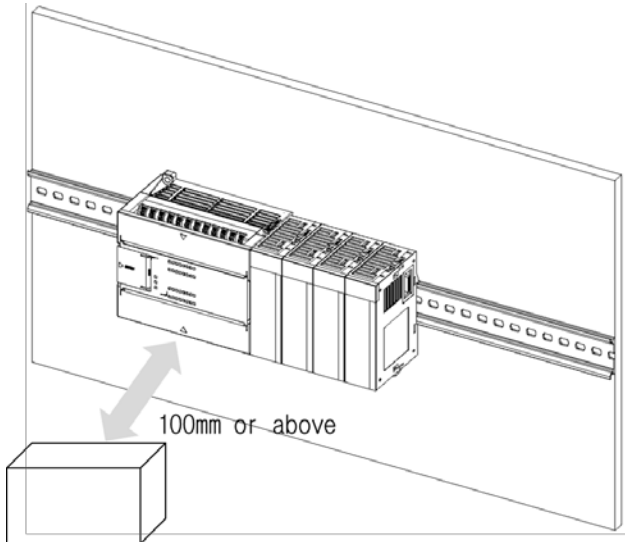

9.2.2 Caution in handling

Here describes caution from open to install

- Don't drop or impact product.
- Don't disassemble the PCB from case. It may cause the error.
- In case of wiring, make sure foreign substance not to enter upper part of module. If it enters, eliminate it.

(1) Caution in handling IO module

It describes caution in handling IO module.

(a) Recheck of IO module specification

For input module, be cautious about input voltage, for output module, if voltage that exceeds the max. open/close voltage is induced, it may cause the malfunction, breakdown or fire.

(b) Used wire

When selecting wire, consider ambient temp, allowed current and minimum size of wire is AWG22(0.3mm²) or above.

(c) Environment

In case of wiring IO module, if device or material that induce high heat is too close or oil contacts wire too long time, it may cause short, malfunction or error.

(d) Polarity

Before supplying power of module which has terminal block, check the polarity.

(e) Wiring

- In case of wiring IO with high voltage line or power line, induced obstacle may cause error.
- Let no cable pass the IO operation indication part (LED).
(You can't discriminate the IO indication.)
- In case induced load is connected with output module, connect the surge killer or diode load to load in parallel. Connect cathode of diode to + side of power.

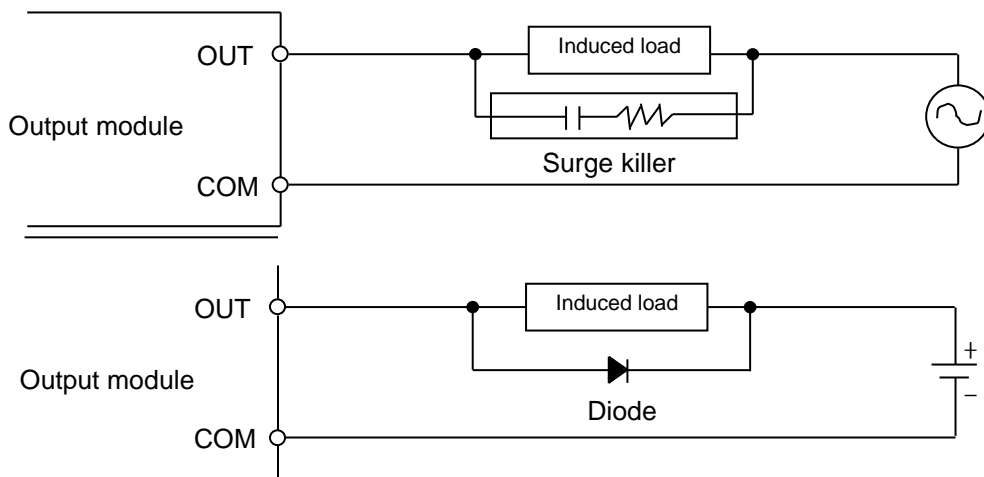

(f) Terminal block

Check close adhesion status. Let no foreign material of wire enter into PLC when wiring terminal block or processing screw hole. At this case, it may cause malfunction.

(g) Don't impact to IO module or don't disassemble the PCB from case.

9.3 Wire

In case using system, it describes caution about wiring.

! Danger

- ▶ When wiring, cut off the external power.
- ▶ If all power is cut, it may cause electric shock or damage of product.
- ▶ In case of flowing electric or testing after wiring, equip terminal cover included in product. If not, it may cause electric shock.

! Caution

- ▶ Do D type ground (type 3 ground) or above dedicated for PLC for FG and LG terminal. It may cause electric shock or malfunction.
- ▶ When wiring module, check the rated voltage and terminal array and do properly.
If rating is different, it may cause fire, malfunction.
- ▶ For external connecting connector, use designated device and solder.
If connecting is not safe, it may cause short, fire, malfunction.
- ▶ For screwing, use designated torque range. If it is not fit, it may cause short, fire, malfunction.
- ▶ Let no foreign material enter such as garbage or disconnection part into module. It may cause fire, malfunction, error.

9.3.1 Power wiring

(1) In case voltage regulation is larger than specified, connect constant voltage transformer.

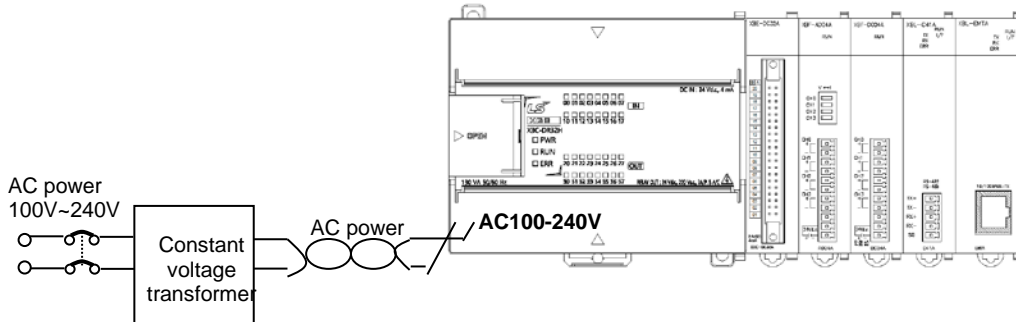

(2) Connect noise that include small noise between line and earth.
(When there are many noise, connect insulated transformer.)

Chapter 9. Installation and Wiring

(3) Isolate the PLC power, I/O devices and power devices as follows.

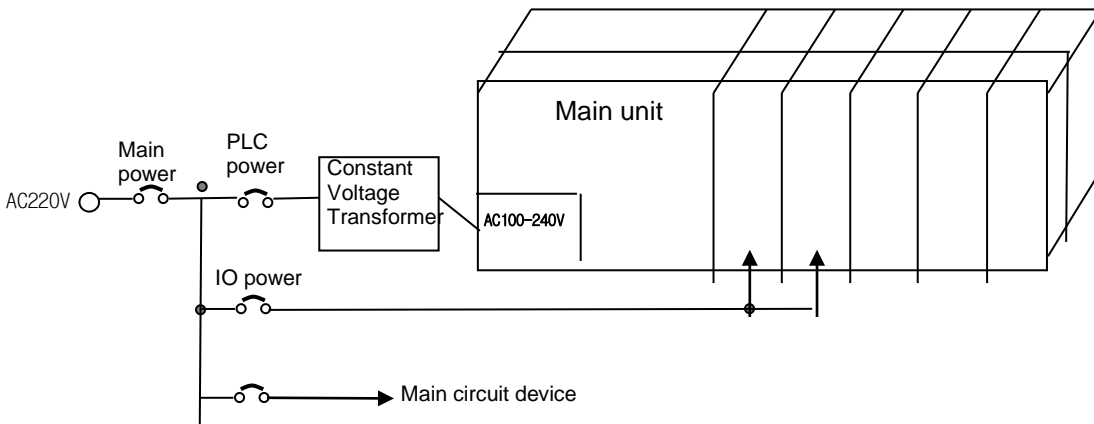

(4) If using DC24V of the power module

- (a) Do not connect DC24V of several power modules in parallel. It may cause the destruction of a module.
- (b) If a power module can not meet the DC24V output capacity, supply DC24V externally as presented below.

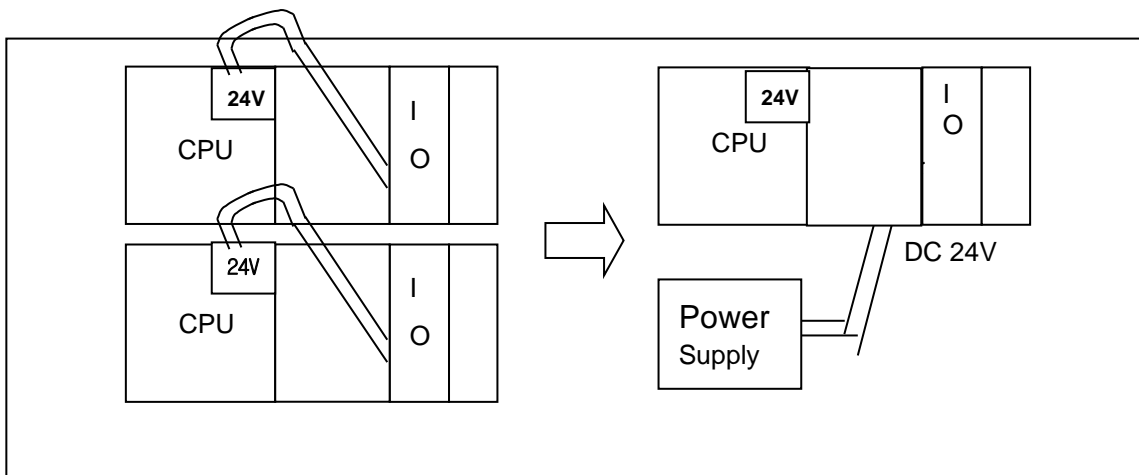

(5) AC110V/AC220V/DC24V cables should be compactly twisted and connected in the shortest distance.

(6) AC110V/AC220V cable should be as thick as possible(2mm²) to reduce voltage drop.

(7) AC110V/ DC24V cables should not be installed close to main circuit cable(high voltage/high current) and I/O signal cable. They should be 100mm away from such cables

(8) To prevent surge from lightning, use the lightning surge absorber as presented below.

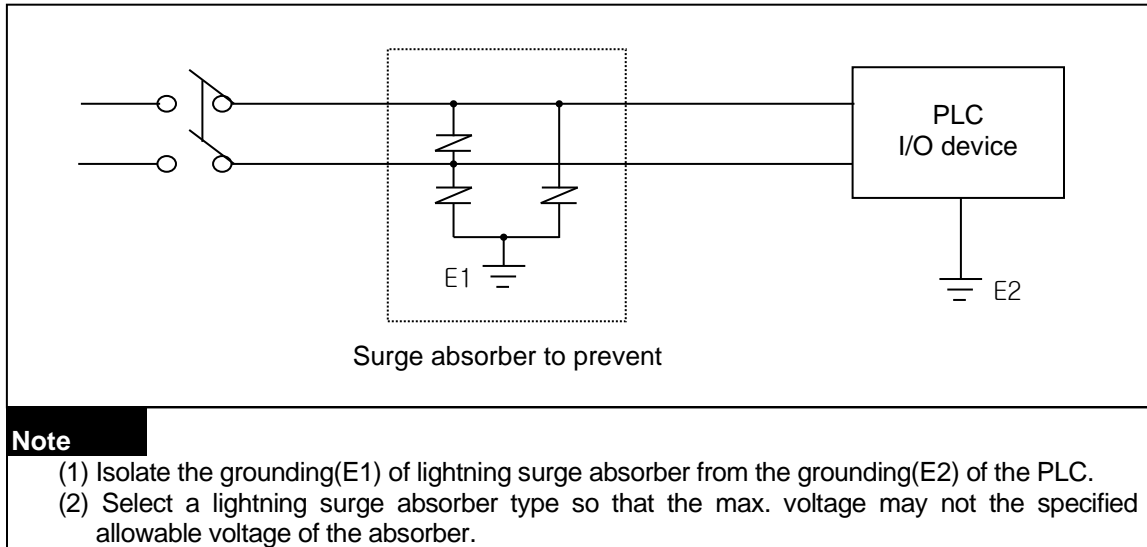

(9) When noise may be intruded inside it, use an insulated shielding transformer or noise filter.

(10) Wiring of each input power should be twisted as short as possible and the wiring of shielding transformer or noise filter should not be arranged via a duct.

(11) All field-wiring connections to this unit shall be from Limited Voltage / Limited Current, below 24Vdc isolated secondary source with an output fused with a 4A fuse max. or class 2 secondary circuits as defined in UL 508, 17th Edition.

9.3.2 I/O Device wiring

- (1) The size of I/O device cable is limited to 0.3~2 mm² but it is recommended to select a size(0.3 mm²) to use conveniently.
- (2) Please isolate input signal line from output signal line.
- (3) I/O signal lines should be wired 100mm and more away from high voltage/high current main circuit cable.
- (4) Batch shield cable should be used and the PLC side should be grounded unless the main circuit cable and power cable can not be isolated.

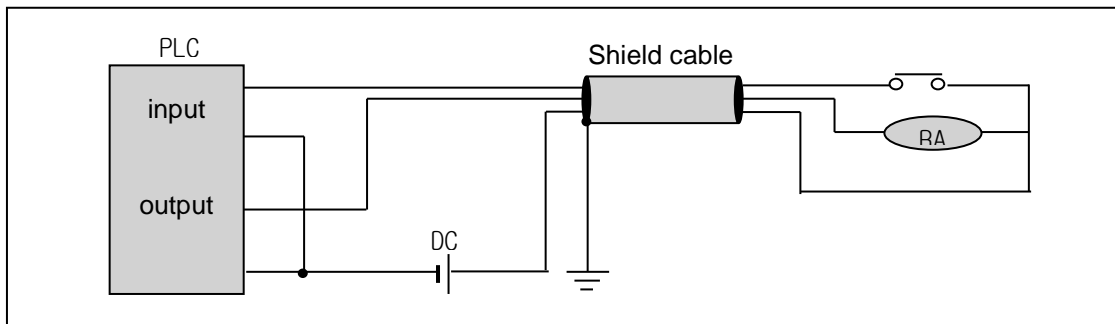

- (5) When applying pipe-wiring, make sure to firmly ground the piping.

9.3.3 Grounding wiring

- (1) The PLC contains a proper noise measure, so it can be used without any separate grounding if there is a large noise. However, if grounding is required, please refer to the followings.
- (2) For grounding, please make sure to use the exclusive grounding.
For grounding construction, apply type 3 grounding(grounding resistance lower than 100 Ω)
- (3) If the exclusive grounding is not possible, use the common grounding as presented in B) of the figure below.

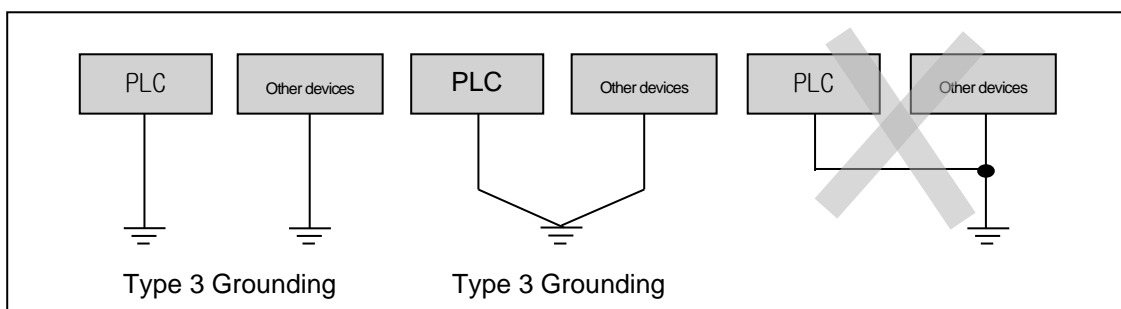

- A) Exclusive grounding : best B) common grounding : good C) common grounding: defective

- (4) Use the grounding cable more than 2 mm². To shorten the length of the grounding cable, place the grounding point as close to the PLC as possible.
- (5) If any malfunction from grounding is detected, separate the FG of the base from the grounding.

9.3.4 Specifications of wiring cable

The specifications of cable used for wiring are as follows.

Types of external connection	Cable specification (mm ²)		Wire Type	Temperature rating
	Lower limit	Upper limit		
Digital input	0.18 (AWG24)	1.5 (AWG16)	Cu	60°C/75°C
Digital output	0.18 (AWG24)	2.0 (AWG14)		
Analogue I/O	0.18 (AWG24)	1.5 (AWG16)		
Communication	0.18 (AWG24)	1.5 (AWG16)		
Main power	1.5 (AWG16)	2.5 (AWG12)		
Protective grounding	1.5 (AWG16)	2.5 (AWG12)		

Chapter 10 Maintenance

Be sure to perform daily and periodic maintenance and inspection in order to maintain the PLC in the best conditions.

10.1 Maintenance and Inspection

The I/O module mainly consist of semiconductor devices and its service life is semi-permanent. However, periodic inspection is requested for ambient environment may cause damage to the devices. When inspecting one or two times per six months, check the following items.

Check Items		Judgment	Corrective Actions
Change rate of input voltage		Within change rate of input voltage (Less than -15% to +20%)	Hold it with the allowable range.
Power supply for input/output		Input/Output specification of each module	Hold it with the allowable range of each module.
Ambient environment	Temperature	0 ~ + 55°C	Adjust the operating temperature and humidity with the defined range.
	Humidity	5 ~ 95%RH	
	Vibration	No vibration	Use vibration resisting rubber or the vibration prevention method.
Play of modules		No play allowed	Securely enrage the hook.
Connecting conditions of terminal screws		No loose allowed	Retighten terminal screws.
Spare parts		Check the number of Spare parts and their Store conditions	Cover the shortage and improve the conditions.

10.2 Daily Inspection

The following table shows the inspection and items which are to be checked daily.

Check Items		Check Points	Judgment	Corrective Actions
Connection conditions of base		Check the screws.	Screws should not be loose.	Retighten Screws.
Connection conditions of Input/Output module		Check the connecting screws Check module cover.	Screws should not be loose.	Retighten Screws.
Connecting conditions of terminal block or extension cable		Check for loose mounting screws.	Screws should not be loose.	Retighten Screws.
		Check the distance between solderless terminals.	Proper clearance should be provided.	Correct.
		Connecting of expansion cable.	Connector should not be loose.	Correct.
LED indicator	PWR LED	Check that the LED is On.	On(Off indicates an error)	See chapter 5.
	Run LED	Check that the LED is On during Run.	On (flickering indicates an error)	See chapter 5.
	ERR LED	Check that the LED is Off during Run.	Off(On indicates an error)	See chapter 5.
	Input LED	Check that the LED turns On and Off.	On when input is On, Off when input is off.	See chapter 5.
	Output LED	Check that the LED turns On and Off	On when output is On, Off when output is off	See chapter 5.

10.3 Periodic Inspection

Check the following items once or twice every six months, and perform the needed corrective actions.

Check Items		Checking Methods	Judgment	Corrective Actions
Ambient environment	Ambient temperature	- Measure with thermometer and hygrometer - measure corrosive gas	0 ~ 55 °C	Adjust to general standard (Internal environmental standard of control section)
	Ambient Humidity		5 ~ 95%RH	
	Ambient pollution level		There should be no corrosive gases	
PLC Conditions	Looseness, Ingress	The module should be move the unit	The module should be mounted securely.	Retighten screws
	dust or foreign material	Visual check	No dust or foreign material	
Connecting conditions	Loose terminal screws	Re-tighten screws	Screws should not be loose	Retighten
	Distance between terminals	Visual check	Proper clearance	Correct
	Loose connectors	Visual check	Connectors should not be loose.	Retighten connector mounting screws
Line voltage check		Measure voltage between input terminals	DC24V: DC20.4 ~ 28.8V	Change supply power

Chapter 11 Troubleshooting

The following explains contents, diagnosis and corrective actions for various errors that can occur during system operation.

11.1 Basic Procedure of Troubleshooting

System reliability not only depends on reliable equipment but also on short downtimes in the event of fault. The short discovery and corrective action is needed for speedy operation of system. The following shows the basic instructions for troubleshooting.

1) Visual checks

Check the following points.

- Machine operating condition (in stop and operation status)
- Power On/Off
- Status of I/O devices
- Condition of wiring (I/O wires, extension and communications cables)
- Display states of various indicators (such as POWER LED, RUN LED, ERR LED and I/O LED)

After checking them, connect peripheral devices and check the operation status of the PLC and the program contents.

2) Trouble Check

Observe any change in the error conditions during the following.

- Switch to the STOP position, and then turn the power on and off.

3) Narrow down the possible causes of the trouble where the fault lies, i.e.:

- Inside or outside of the PLC ?
- I/O module or another module?
- PLC program?

11.2 Troubleshooting

This section explains the procedure for determining the cause of troubles as well as the errors and corrective actions.

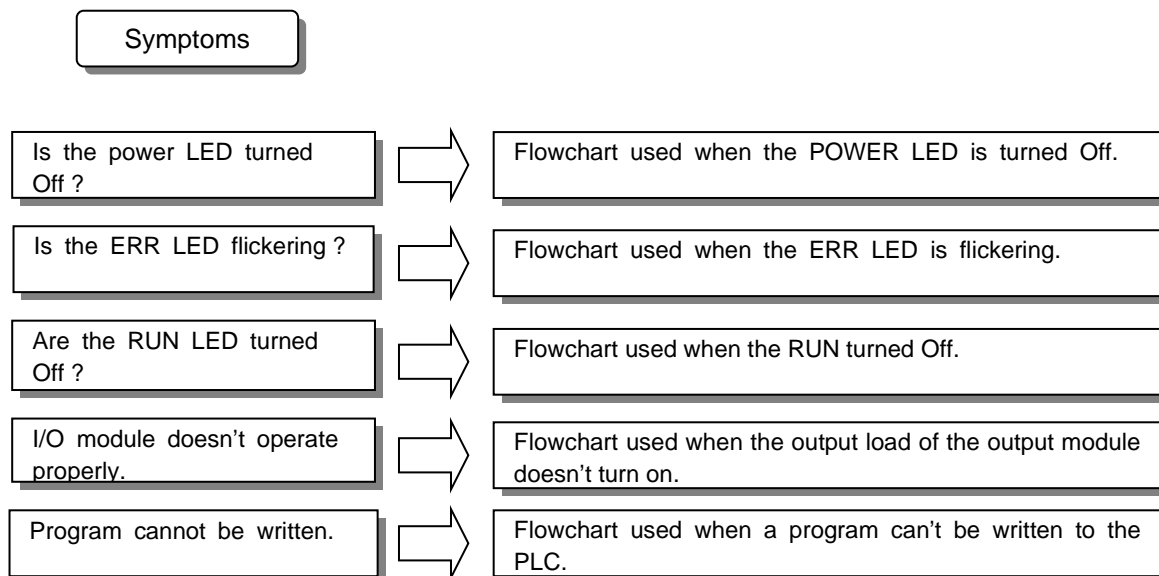

11.2.1 Troubleshooting flowchart used when the PWR (Power) LED turns Off.

The following flowchart explains corrective action procedure used when the power is supplied or the power LED turns Off during operation.

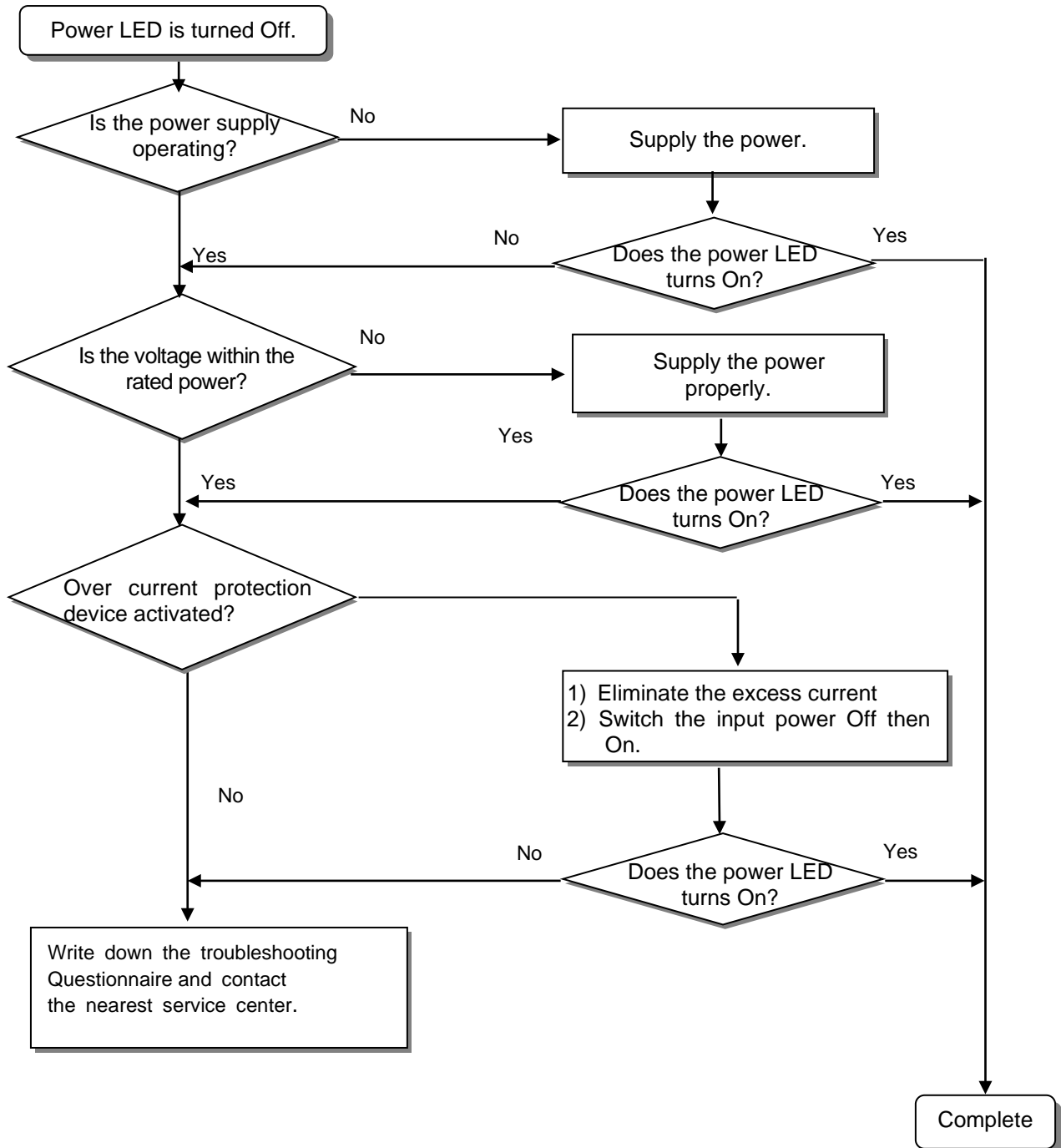

11.2.2 Troubleshooting flowchart used with when the ERR (Error) LED is flickering

The following flowchart explains corrective action procedure use when the power is supplied starts or t he ERR LED is flickering during operation.

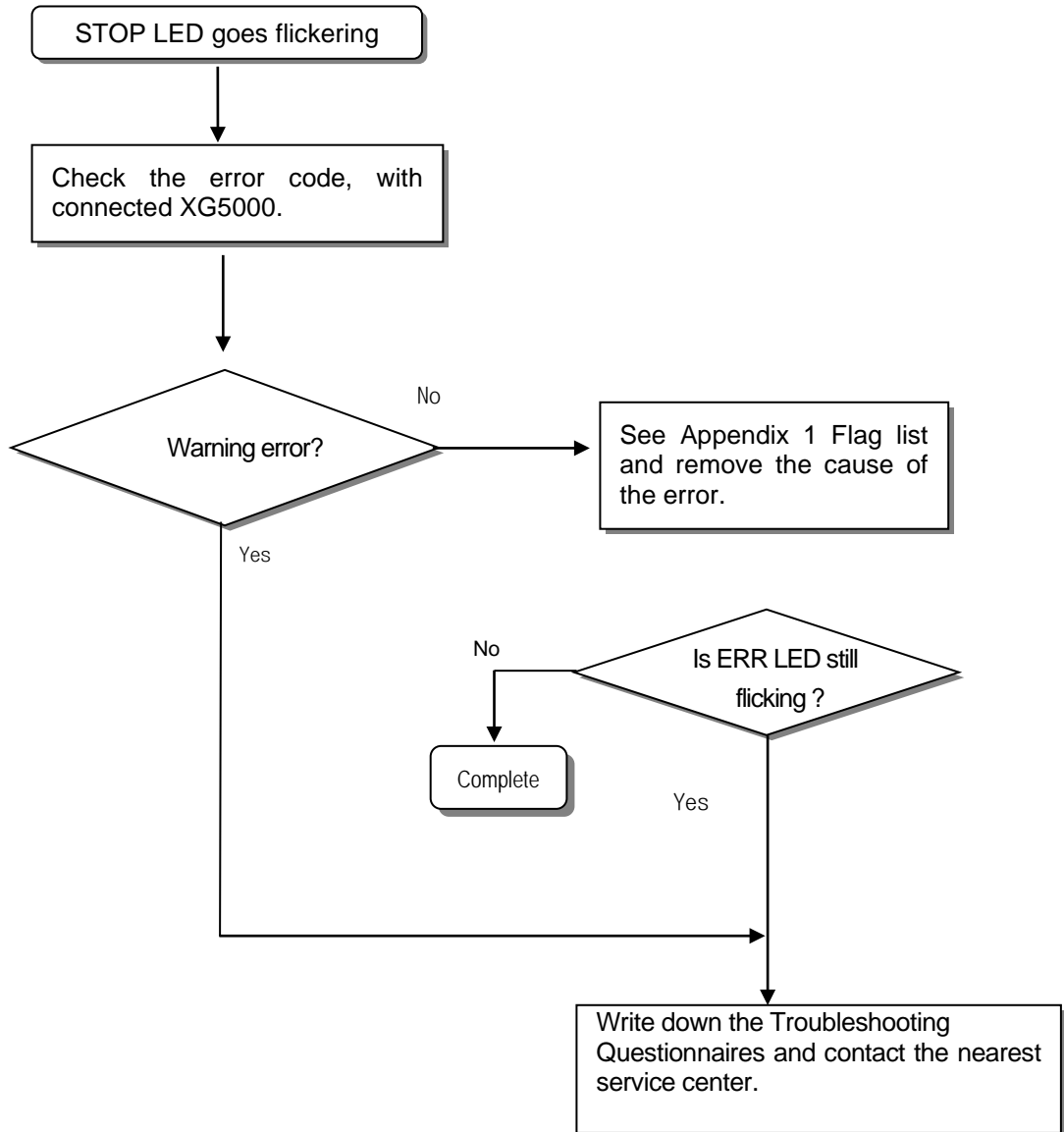

Warning

Though warning error appears, PLC system doesn't stop but corrective action is needed promptly. If not, it may cause the system failure.

11.2.3 Troubleshooting flowchart used with when the RUN , STOP LED turns Off.

The following flowchart explains corrective action procedure to treat the lights-out of RUN LED when the power is supplied, operation starts or operation is in the process.

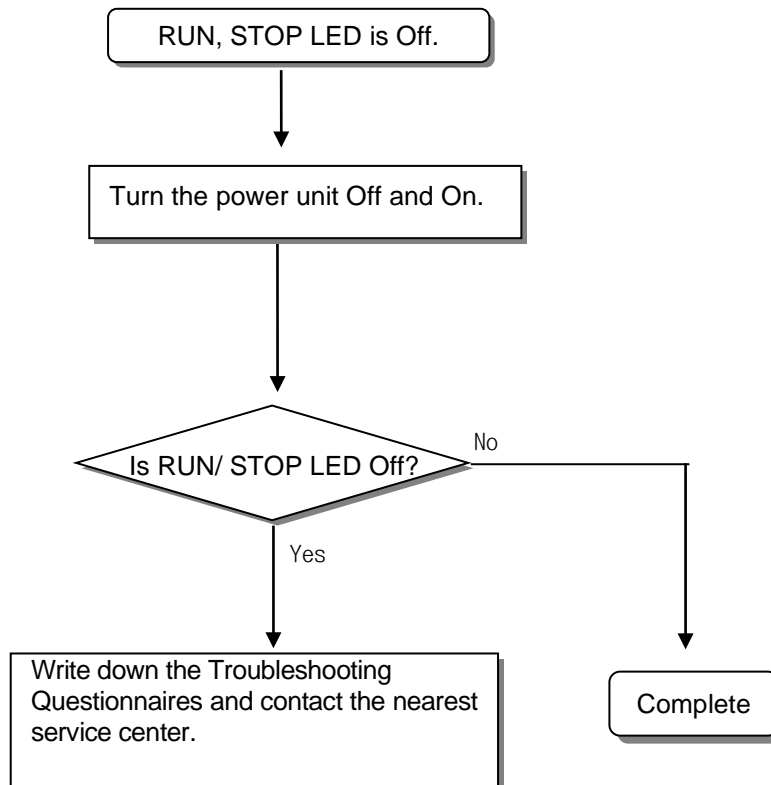

11.2.4 Troubleshooting flowchart used when the I/O part doesn't operate normally.

The following flowchart explains corrective action procedure used when the I/O module doesn't operate normally.

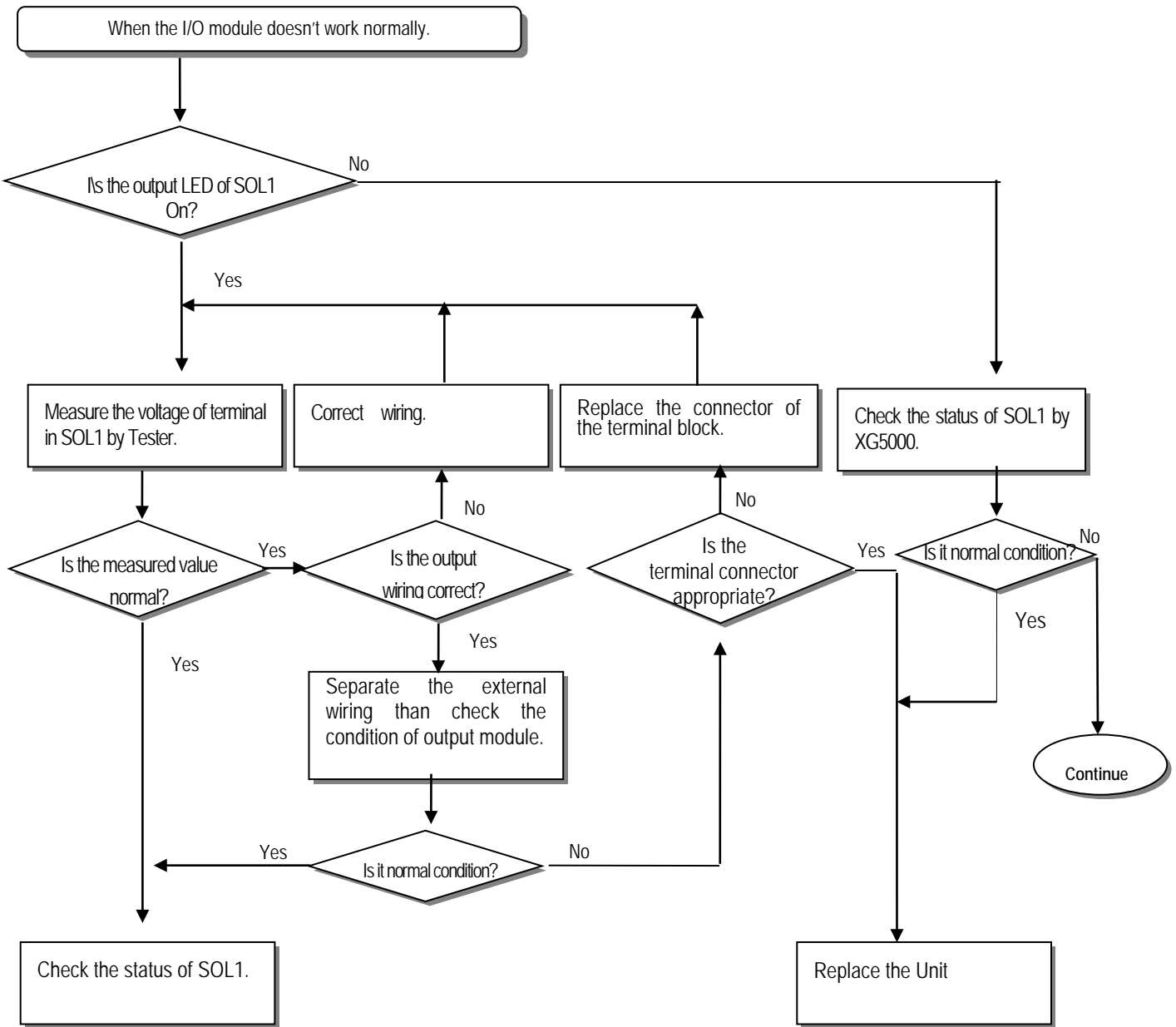
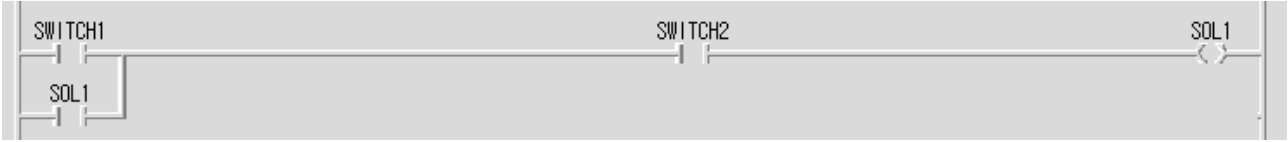

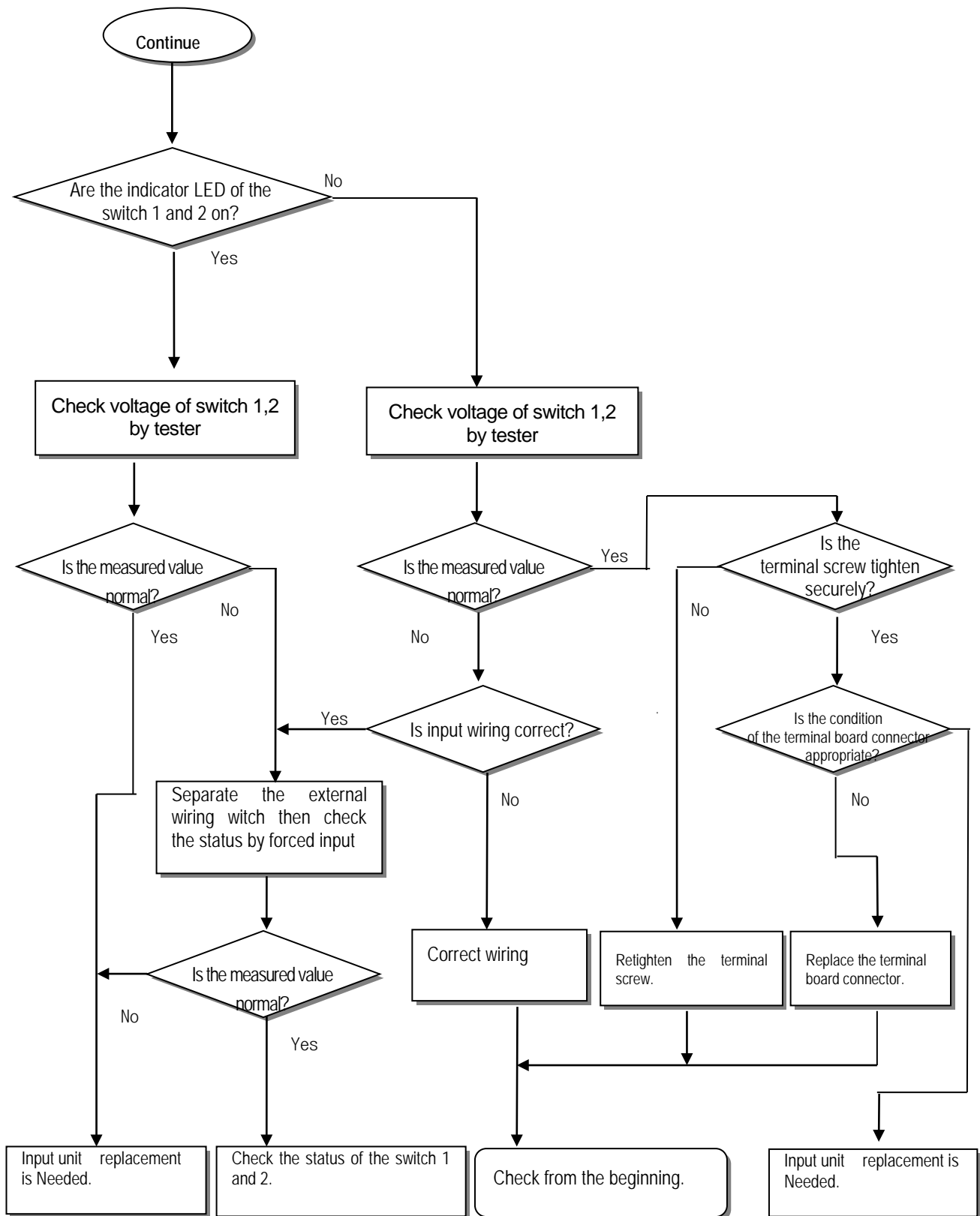

11.3 Troubleshooting Questionnaire

When problems have been met during operation of the XGC series, please write down this Questionnaires and contact the service center via telephone or facsimile.

- For errors relating to special or communication modules, use the questionnaire included in the User's manual of the unit.

1. Telephone & FAX No
Tell) FAX)

2. Using equipment model:

3. Details of using equipment

CPU model: () OS version No.:() Serial No.()
XG5000 (for program compile) version No.: ()

4.General description of the device or system used as the control object:

5. The kind of the base unit:

- Operation by the mode setting switch (),
- Operation by the XG5000 or communications (),
- External memory module operation (),

6. Is the ERR. LED of the CPU module turned On ? Yes(), No()

7. XG5000 error message:

8. History of corrective actions for the error message in the article 7:

9. Other tried corrective actions:

10. Characteristics of the error

- Repetitive(): Periodic(), Related to a particular sequence(), Related to environment()
- Sometimes(): General error interval:

11. Detailed Description of error contents:

12. Configuration diagram for the applied system:

11.4 Troubleshooting Examples

Possible troubles with various circuits and their corrective actions are explained.

11.4.1 Input circuit troubles and corrective actions

The followings describe possible troubles with input circuits, as well as corrective actions.

Condition	Cause	Corrective Actions
Input signal doesn't turn off.	Leakage current of external device (Such as a drive by non-contact switch) 	<ul style="list-style-type: none"> Connect an appropriate register and capacity, which will make the voltage lower across the terminals of the input module.
Input signal doesn't turn off. (Neon lamp may be still on)	Leakage current of external device (Drive by a limit switch with neon lamp) 	<ul style="list-style-type: none"> CR values are determined by the leakage current value. – Recommended value C : 0.1 ~ 0.47 μF R: 47 ~ 120 Ω (1/2W) Or make up another independent display circuit.
Input signal doesn't turn off.	Leakage current due to line capacity of wiring cable. 	<ul style="list-style-type: none"> Locate the power supply on the external device side as shown below.
Input signal doesn't turn off.	Leakage current of external device (Drive by switch with LED indicator) 	<ul style="list-style-type: none"> Connect an appropriate register, which will make the voltage higher than the OFF voltage across the input module terminal and common terminal.
Input signal doesn't turn off.	<ul style="list-style-type: none"> Sneak current due to the use of two different power supplies. <ul style="list-style-type: none"> E1 > E2, sneaked. 	<ul style="list-style-type: none"> Use only one power supply. Connect a sneak current prevention diode.

11.4.2 Output circuit and corrective actions

The following describes possible troubles with output circuits, as well as their corrective actions.

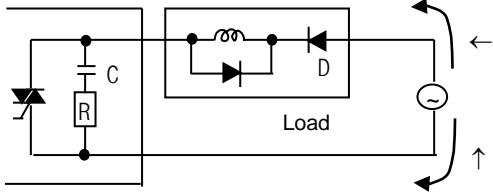
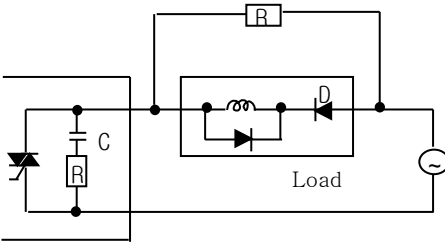
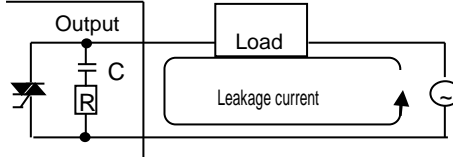
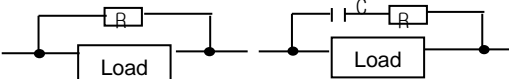
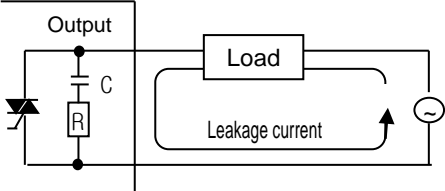
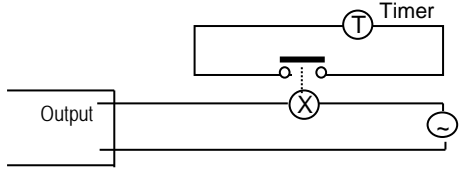
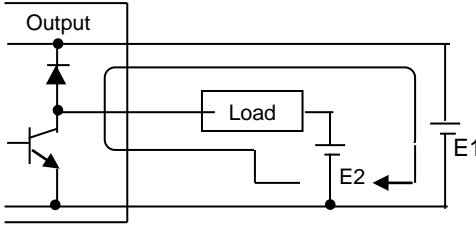
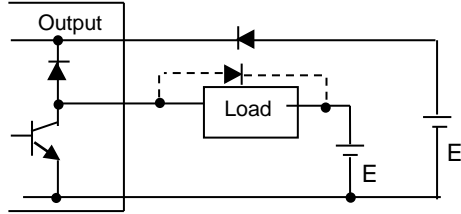
Condition	Cause	Corrective Action
<p>When the output is off, excessive voltage is applied to the load.</p>	<ul style="list-style-type: none"> • Load is half-wave rectified inside (in some cases, it is true of a solenoid) • When the polarity of the power supply is as shown in ①, C is charged. When the polarity is as shown in ②, the voltage charged in C plus the line voltage are applied across D. Max. voltage is approx. $2\sqrt{2}$.  <p>*) If a resistor is used in this way, it does not pose a problem to the output element. But it may make the performance of the diode (D), which is built in the load, drop to cause problems.</p>	<ul style="list-style-type: none"> • Connect registers of tens to hundreds KΩ across the load in parallel. 
<p>The load doesn't turn off.</p>	<ul style="list-style-type: none"> • Leakage current by surge absorbing circuit, which is connected to output element in parallel. 	<ul style="list-style-type: none"> • Connect C and R across the load, which are of registers of tens KΩ. When the wiring distance from the output module to the load is long, there may be a leakage current due to the line capacity. 
<p>When the load is C-R type timer, time constant fluctuates.</p>	<ul style="list-style-type: none"> • Leakage current by surge absorbing circuit, which is connected to output element in parallel. 	<ul style="list-style-type: none"> • Drive the relay using a contact and drive the C-R type timer using the since contact. • Use other timer than the C-R contact some timers have half-wave rectified internal circuits therefore, be cautious. 
<p>The load does not turn off.</p>	<ul style="list-style-type: none"> • Sneak current due to the use of two different power supplies.  <p>$E1 < E2$, sneaks. E1 is off (E2 is on), sneaks.</p>	<ul style="list-style-type: none"> • Use only one power supply. • Connect a sneak current prevention diode.  <p>If the load is the relay, etc, connect a counter-electromotive voltage absorbing code as shown by the dot line.</p>

Output circuit troubles and corrective actions (continued).

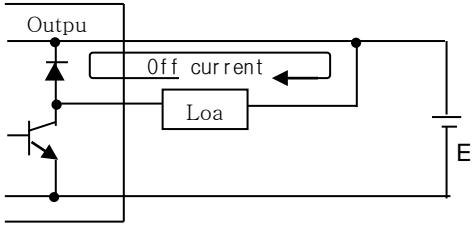
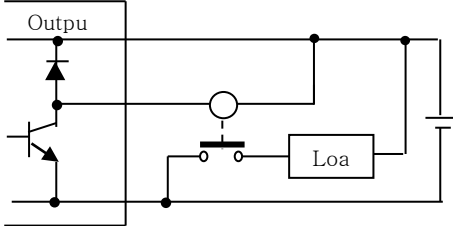
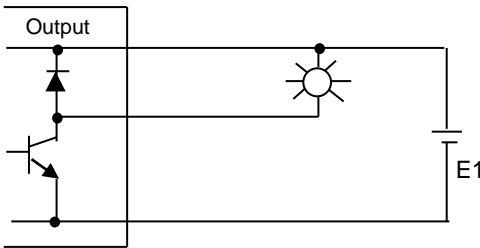
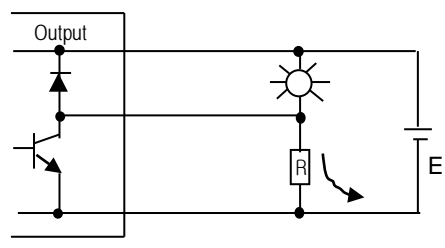
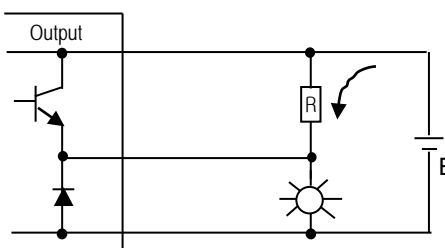
Condition	Cause	Corrective actions
<p>The load off response time is long.</p>	<ul style="list-style-type: none"> Over current at off state [The large solenoid current fluidic load (L/R is large) such as is directly driven with the transistor output.  <ul style="list-style-type: none"> The off response time can be delayed by one or more second as some loads make the current flow across the diode at the off time of the transistor output. 	<ul style="list-style-type: none"> Insert a small L/R magnetic contact and drive the load using the same contact. 
<p>Output transistor is destroyed.</p>	<p>Surge current of the white lamp</p>  <p>A surge current of 10 times or more when turned on.</p>	<ul style="list-style-type: none"> To suppress the surge current make the dark current of 1/3 to 1/5 rated current flow.  <p>Sink type transistor output</p>  <p>Source type transistor output</p>

11.5 Error Code List

Error code	Error cause	Action (restart mode after taking an action)	Operation status	LED status	Diagnosis point
23	Program to execute is abnormal	Start after reloading the program	Warning	0.5 second Flicker	RUN mode
24	I/O parameter error	Start after reloading I/O parameter, Battery change if battery has a problem. Check the preservation status after I/O parameter reloading and if error occurs, change the unit.	Warning	0.5 second Flicker	Reset RUN mode switching
25	Basic parameter error	Start after reloading Basic parameter, Change battery if it has a problem. Check the preservation status after Basic parameter reloading and if error occurs, change the unit.	Warning	0.5 second Flicker	Reset RUN mode switching
30	Module set in parameter and the installed module does not match	modify the module or parameter and then restart.	Warning	0.5 second Flicker	RUN mode switching
31	Module falling during operation or additional setup	After checking the position of attachment/detachment of expansion module during Run mode	Warning	0.1 second Flicker	Every scan
33	Data of I/O module does not access normally during operation.	After checking the position of slot where the access error occurs by XG5000, change the module and restart (acc.to parameter.)	Heavy error	0.1 second Flicker	Scan end
34	Normal access of special/link module data during operation not available	After checking the position of slot that access error occurred by XG5000, change the module and restart (acc.to parameter).	Heavy error	0.1 second Flicker	Scan end
39	Abnormal stop of CPU or malfunction	Abnormal system end by noise or hard ware error. 1) If it occurs repeatedly when power reinput, request service center 2) Noise measures	Heavy error	0.1 second Flicker	Ordinary time
40	Scan time of program during operation exceeds the scan watchdog time designated by parameter.	After checking the scan watchdog time designated by parameter, modify the parameter or the program and then restart.	Warning	0.5 second Flicker	While running the program
41	Operation error occurs while running the user program.	Remove operation error → reload the program and restart.	Warning	0.5 second Flicker	While running the program
44	Timer index user error	After reloading a timer index program modification, start	Warning	0.5 second Flicker	Scan end
50	Heavy error of external device	Refer to Heavy error detection flag and modifies the device and restart. (Acc. Parameter)	Heavy error	1 second Flicker	Scan end
60	E_STOP function executed	After removing error causes which starts E_STOP function in program, power reinput	Heavy error	1 second Flicker	While running the program

Error code	Error cause	Action (restart mode after taking an action)	Operation status	LED status	Diagnosis point
500	Data memory backup not possible	If not error in battery, power reinput Remote mode is switched to STOP mode.	Warning	1 second Flicker	Reset
501	Abnormal clock data	Setting the time by XG5000 if there is no error	Warning	0.1 second Flicker	Ordinary time
502	Battery voltage falling	Battery change at power On status	Warning	0.1 second Flicker	Ordinary time

Appendix 1 Flag List

Appendix 1.1 Special Relay (F) List

Word	Bit	Variables	Function	Description
F000~1	-	_SYS_STATE	Mode and state	Indicates PLC mode and operation State.
	F0000	_RUN	Run	Run state.
	F0001	_STOP	Stop	Stop state.
	F0002	_ERROR	Error	Error state.
	F0003	_DEBUG	Debug	Debug state.
	F0004	_LOCAL_CON	Local control	Local control mode.
	F0006	_REMOTE_CON	Remote mode	Remote control mode.
	F0008	_RUN_EDIT_ST	Editing during RUN	Editing program download during RUN.
	F0009	_RUN_EDIT_CHK	Editing during RUN	Internal edit processing during RUN.
	F000A	_RUN_EDIT_DONE	Edit done during RUN	Edit is done during RUN.
	F000B	_RUN_EDIT_END	Edit end during RUN	Edit is ended during RUN.
	F000C	_CMOD_KEY	Operation mode	Operation mode changed by key.
	F000D	_CMOD_LPADT	Operation mode	Operation mode changed by local PADT.
	F000E	_CMOD_RPADT	Operation mode	Operation mode changed by Remote PADT.
	F000F	_CMOD_RLINK	Operation mode	Operation mode changed by Remote communication module.
	F0010	_FORCE_IN	Forced input	Forced input state.
	F0011	_FORCE_OUT	Forced output	Forced output state.
	F0014	_MON_On	Monitor	Monitor on execution.
	F0015	_USTOP_On	Stop	Stop by Stop function.
	F0016	_ESTOP_On	EStop	Stop by EStop function.
	F0017	_CONPILE_MODE	Compile	Compile on execution.
	F0018	_INIT_RUN	Initialize	Initialization task on execution.
	F001C	_PB1	Program Code 1	Program Code 1 selected.
	F001D	_PB2	Program Code 2	Program Code 2 selected.
	F001E	_CB1	Compile Code 1	Compile Code 1 selected.
	F001F	_CB2	Compile Code2	Compile Code 2 selected.
F002~3	-	_CNF_ER	System error	Reports heavy error state of system.
	F0021	_IO_TYER	Module Type error	Module Type does not match.
	F0022	_IO_DEER	Module detachment error	Module is detached.
	F0024	_IO_RWER	Module I/O error	Module I/O error.
	F0025	_IP_IFER	Module interface error	Special/communication module interface error.
	F0026	_ANNUM_ER	External device error	Detected heavy error in external Device.

Word	Bit	Variable	Function	Description
F002~3	F0028	_BPRM_ER	Basic parameter	Basic parameter error.
	F0029	_IOPRM_ER	IO parameter	I/O configuration parameter error.
	F002A	_SPPRM_ER	Special module parameter	Special module parameter is Abnormal.
	F002B	_CPPRM_ER	Communication module parameter	Communication module parameter is abnormal.
	F002C	_PGM_ER	Program error	Program error.
	F002D	_CODE_ER	Code error	Program Code error.
	F002E	_SWDT_ER	System watchdog	System watchdog operated.
	F0030	_WDT_ER	Scan watchdog	Scan watchdog operated.
F004	-	_CNF_WAR	System warning	Reports light error state of system.
	F0041	_DBCK_ER	Backup error	Data backup error.
	F0043	_ABSD_ER	Operation shutdown error	Stop by abnormal operation.
	F0046	_ANNUM_WAR	External device error	Detected light error of external device.
	F0048	_HS_WAR1	High speed link 1	High speed link – parameter 1 error.
	F0049	_HS_WAR2	High speed link 2	High speed link – parameter 2 error.
	F0054	_P2P_WAR1	P2P parameter 1	P2P – parameter 1 error.
	F0055	_P2P_WAR2	P2P parameter 2	P2P – parameter 2 error.
	F0056	_P2P_WAR3	P2P parameter 3	P2P – parameter 3 error.
F005C	_CONSTANT_ER	Constant error	Constant error.	
F009	-	_USER_F	User contact	Timer used by user.
	F0090	_T20MS	20ms	20ms cycle Clock.
	F0091	_T100MS	100ms	100ms cycle Clock.
	F0092	_T200MS	200ms	200ms cycle Clock.
	F0093	_T1S	1s Clock	1s cycle Clock.
	F0094	_T2S	2 s Clock	2s cycle Clock.
	F0095	_T10S	10 s Clock	10s cycle Clock.
	F0096	_T20S	20 s Clock	20s cycle Clock.
	F0097	_T60S	60 s Clock	60s cycle Clock.
	F0099	_On	Ordinary time On	Always On state Bit.
	F009A	_Off	Ordinary time Off	Always Off state Bit.
	F009B	_1On	1scan On	First scan On Bit.
	F009C	_1Off	1scan Off	First scan OFF bit.
	F009D	_STOG	Reversal	Reversal every scan.

Appendix 1. Flag List

Word	Bit	Variable	Function	Description
F010	-	_USER_CLK	User Clock	Clock available for user setting.
	F0100	_USR_CLK0	Setting scan repeat	On/Off as much as set scan Clock 0.
	F0101	_USR_CLK1	Setting scan repeat	On/Off as much as set scan Clock 1.
	F0102	_USR_CLK2	Setting scan repeat	On/Off as much as set scan Clock 2.
	F0103	_USR_CLK3	Setting scan repeat	On/Off as much as set scan Clock 3.
	F0104	_USR_CLK4	Setting scan repeat	On/Off as much as set scan Clock 4.
	F0105	_USR_CLK5	Setting scan repeat	On/Off as much as set scan Clock 5.
	F0106	_USR_CLK6	Setting scan repeat	On/Off as much as set scan Clock 6.
	F0107	_USR_CLK7	Setting scan repeat	On/Off as much as set scan Clock 7.
F011	-	_LOGIC_RESULT	Logic result	Indicates logic results.
	F0110	_LER	operation error	On during 1 scan in case of operation error.
	F0111	_ZERO	Zero flag	On when operation result is 0.
	F0112	_CARRY	Carry flag	On when carry occurs during operation.
	F0113	_ALL_Off	All output OFF	On in case that all output is Off.
	F0115	_LER_LATCH	Operation error Latch	Keeps On during operation error.
F012	-	_CMP_RESULT	Comparison result	Indicates the comparison result.
	F0120	_LT	LT flag	On in case of "less than".
	F0121	_LTE	LTE flag	On in case of "equal or less than".
	F0122	_EQU	EQU flag	On in case of "equal".
	F0123	_GT	GT flag	On in case of "greater than".
	F0124	_GTE	GTE flag	On in case of "equal or greater than".
	F0125	_NEQ	NEQ flag	On in case of "not equal".
F014	-	_FALS_NUM	FALS no.	Indicates FALS no.
F015	-	_PUTGET_ERR0	PUT/GET error 0	Main base Put / Get error.
F023	-	_PUTGET_NDR0	PUT/GET end 0	Main base Put/Get end.
F044	-	_CPU_TYPE	CPU Type	Indicates information for CPU Type.
F045	-	_CPU_VER	CPU version	Indicates CPU version.
F046	-	_OS_VER	OS version	Indicates OS version.
F048	-	_OS_DATE	OS date	Indicates OS distribution date.
F050	-	_SCAN_MAX	Max. scan time	Indicates max. scan time.
F051	-	_SCAN_MIN	Min. scan time	Indicates min. scan time.
F052	-	_SCAN_CUR	Current scan time	Current scan time.
F0053	-	_MON_YEAR	Month/year	Clock data (month/year)
F0054	-	_TIME_DAY	Hour/date	Clock data (hour/date)
F0055	-	_SEC_MIN	Second/minute	Clock data (Second/minute)
F0056	-	_HUND_WK	Hundred year/week	Clock data (Hundred year/week)

Word	Bit	Variable	Function	Description
F057	-	_FPU_INFO	N/A	-
	F0570	_FPU_LFLAG_I	N/A	-
	F0571	_FPU_LFLAG_U	N/A	-
	F0572	_FPU_LFLAG_O	N/A	-
	F0573	_FPU_LFLAG_Z	N/A	-
	F0574	_FPU_LFLAG_V	N/A	-
	F057A	_FPU_FLAG_I	N/A	-
	F057B	_FPU_FLAG_U	N/A	-
	F057C	_FPU_FLAG_O	N/A	-
	F057D	_FPU_FLAG_Z	N/A	-
	F057E	_FPU_FLAG_V	N/A	-
	F057F	_FPU_FLAG_E	Irregular input	Reports in case of irregular input.
F058	-	_ERR_STEP	Error step	Saves error step.
F060	-	_REF_COUNT	Refresh	Increase when module Refresh.
F062	-	_REF_OK_CNT	Refresh OK	Increase when module Refresh is normal.
F064	-	_REF_NG_CNT	Refresh NG	Increase when module Refresh is Abnormal.
F066	-	_REF_LIM_CNT	Refresh Limit	Increase when module Refresh is abnormal (Time Out).
F068	-	_REF_ERR_CNT	Refresh Error	Increase when module Refresh is Abnormal.
F070	-	_MOD_RD_ERR_CNT	-	-
F072	-	_MOD_WR_ERR_CNT	-	-
F074	-	_CA_CNT	-	-
F076	-	_CA_LIM_CNT	-	-
F078	-	_CA_ERR_CNT	-	-
F080	-	_BUF_FULL_CNT	Buffer Full	Increase when CPU internal buffer is full.
F082	-	_PUT_CNT	Put count	Increase when Put count.
F084	-	_GET_CNT	Get count	Increase when Get count.
F086	-	_KEY	Current key	indicates the current state of local key.
F088	-	_KEY_PREV	Previous key	indicates the previous state of local key
F090	-	_IO_TYER_N	Mismatch slot	Module Type mismatched slot no.
F091	-	_IO_DEER_N	Detach slot	Module detached slot no.
F093	-	_IO_RWER_N	RW error slot	Module read/write error slot no.
F094	-	_IP_IFER_N	IF error slot	Module interface error slot no.
F096	-	_IO_TYER0	Module Type 0 error	Main base module Type error.

Appendix 1. Flag List

Word	Bit	Variable	Function	Description
F104	-	_IO_DEER0	Module Detach 0 error	Main base module Detach error.
F120	-	_IO_RWER0	Module RW 0 error	Main base module read/write error.
F128	-	_IO_IFER_0	Module IF 0 error	Main base module interface error.
F140	-	_AC_FAIL_CNT	Power shutdown times	Saves the times of power shutdown.
F142	-	_ERR_HIS_CNT	Error occur times	Saves the times of error occur.
F144	-	_MOD_HIS_CNT	Mode conversion times	Saves the times of mode conversion.
F146	-	_SYS_HIS_CNT	History occur times	Saves the times of system history.
F148	-	_LOG_ROTATE	Log Rotate	Saves log rotate information.
F150	-	_BASE_INFO0	Slot information 0	Main base slot information.
F200	-	_USER_WRITE_F	Available contact point	Contact point available in program.
	F2000	_RTC_WR	RTC RW	Data write and read in RTC.
	F2001	_SCAN_WR	Scan WR	Initializing the value of scan.
	F2002	_CHK_ANC_ERR	Request detection of external serious error	Request detection of external error.
	F2003	_CHK_ANC_WAR	Request detection of external slight error (warning)	Request detection of external slight error (warning).
F201	-	_USER_STAUS_F	User contact point	User contact point.
	F2010	_INIT_DONE	Initialization completed	Initialization complete displayed.
F202	-	_ANC_ERR	Display information of external serious error	Display information of external serious error
F203	-	_ANC_WAR	Display information of external slight error (warning)	Display information of external slight error (warning)
F210	-	_MON_YEAR_DT	Month/year	Clock data (month/year)
F211	-	_TIME_DAY_DT	Hour/date	Clock data (hour/date)
F212	-	_SEC_MIN_DT	Second/minute	Clock data (Second/minute)
F213	-	_HUND_WK_DT	Hundred year/week	Clock data (Hundred year/week)

Appendix 1.2 Communication Relay (L) List

Here describes data link communication relay(L).

1. High-speed Link 1

Device	Keyword	Type	Description
L000	_HS1_RLINK	Bit	<p>High speed link parameter 1 normal operation of all station</p> <p>Indicates normal operation of all station according to parameter set in High speed link, and On under the condition as below.</p> <ol style="list-style-type: none"> 1. In case that all station set in parameter is RUN mode and no error, 2. All data block set in parameter is communicated normally, and 3. The parameter set in each station itself is communicated normally. <p>Once RUN_LINK is On, it keeps On unless stopped by LINK_DISABLE.</p>
L001	_HS1_LTRBL	Bit	<p>Abnormal state after _HS1RLINK On</p> <p>In the state of _HSmRLINK flag On, if communication state of the station set in the parameter and data block is as follows, this flag shall be On.</p> <ol style="list-style-type: none"> 1. In case that the station set in the parameter is not RUN mode, or 2. There is an error in the station set in the parameter, or 3. The communication state of data block set in the parameter is not good. <p>LINK TROUBLE shall be On if the above 1, 2 & 3 conditions occur, and if the condition return to the normal state, it shall be OFF again.</p>
L0020 ~ L005F	_HS1_STATE[k] (k = 00~63)	Bit Array	<p>High speed link parameter 1, K block general state</p> <p>Indicates the general state of communication information for each data block of setting parameter. _HS1_STATE[k] = HS1MOD[k]&_HS1TRX[k]&(~_HS1_ERR[k])</p>
L0060 ~ L009F	_HS1_MOD[k] (k = 00~63)	Bit Array	<p>High speed link parameter 1, k block station RUN operation mode</p> <p>Indicates operation mode of station set in K data block of parameter.</p>
L0100 ~ L013F	_HS1_TRX[k] (k = 00~63)	Bit Array	<p>Normal communication with High speed link parameter 1, k block station</p> <p>Indicates if communication state of Kdata of parameter is communicated smoothly according to the setting.</p>
L0140 ~ L017F	_HS1_ERR[k] (k = 00~63)	Bit Array	<p>High speed link parameter 1, K block station operation error mode</p> <p>Indicates if the error occurs in the communication state of k data block of parameter.</p>
L0180 ~ L021F	_HS1_SETBLOCK[k]	Bit Array	<p>High speed link parameter 1, K block setting</p> <p>Indicates whether or not to set k data block of parameter.</p>

2. High-speed Link2

Device	Keyword	Type	Description
L0260	_HS2_RLINK	Bit	<p>High-speed link parameter 2 normal operation of all station.</p> <p>Indicates normal operation of all station according to parameter set in High-speed link and On under the condition as below.</p> <ol style="list-style-type: none"> 1. In case that all station set in parameter is Run mode and no error 2. All data block set in parameter is communicated and 3. The parameter set in each station itself is communicated normally. <p>Once RUN_LINK is On, it keeps On unless stopped by LINK_DISABLE.</p>
L0261	_HS2_LTRBL	Bit	<p>Abnormal state after _HS2RLINK On.</p> <p>In the state of _HSmRLINK flag On, if communication state of the station set in the parameter and data block is as follows, this flag shall be On.</p> <ol style="list-style-type: none"> 1. In case that the station set in the parameter is not RUN mode, or 2. There is an error in the station set in the parameter, or 3. The communication state of data block set in the parameter is not good. <p>LINK TROUBLE shall be On if the above 1, 2 & 3 conditions occur, and if the condition return to the normal state, it shall be OFF again.</p>
L0280 ~ L031F	_HS2_STATE[k] (k = 00~63)	Bit Array	<p>High speed link parameter 1, k block general state.</p> <p>Indicates the general state of communication information for each data block of setting parameter.</p> <p>$_HS2_STATE[k]=HS2MOD[k]\&_HS2TRX[k]\&(\sim_HS2_ERR[k])$</p>
L0320 ~ L035F	_HS2_MOD[k] (k = 00~63)	Bit Array	<p>High speed link parameter 1, k block station RUN operation mode.</p> <p>Indicates operation mode of station set in k data block of parameter.</p>
L0360 ~ L039F	_HS2_TRX[k] (k = 00~63)	Bit Array	<p>Normal communication with High speed link parameter 1, K block station.</p> <p>Indicates if communication state of K data of parameter is communicated smoothly according to the setting.</p>
L0400 ~ L043F	_HS2_ERR[k] (k = 00~63)	Bit Array	<p>High speed link parameter 1, K block station operation error mode.</p> <p>Indicates if the error occurs in the communication state of k data block of parameter.</p>
L0440 ~ L047F	_HS2_SETBLOCK[k]	Bit Array	<p>High speed link parameter 1, K block setting.</p> <p>Indicates whether or not to set k data block of parameter.</p>

3. Common area

Communication flag list according to P2P service setting.
P2P parameter: 1~3, P2P block: 0~31

Device	Keyword	Type	Description
L5120	_P2P1_NDR00	Bit	Indicates P2P parameter 1, 0 Block service normal end.
L5121	_P2P1_ERR00	Bit	Indicates P2P parameter 1, 0 Block service abnormal end.
L513	_P2P1_STATUS00	Word	Indicates error code in case of P2P parameter 1, 0 Block service abnormal end.
L514	_P2P1_SVCCNT00	DWord	Indicates P2P parameter 1, 0 Block service normal count.
L516	_P2P1_ERRCNT00	DWord	Indicates P2P parameter 1, 0 Block service abnormal count.
L5180	_P2P1_NDR01	Bit	P2P parameter 1, 1 Block service normal end.
L5181	_P2P1_ERR01	Bit	P2P parameter 1, 1 Block service abnormal end.
L519	_P2P1_STATUS01	Word	Indicates error code in case of P2P parameter 1, 1 Block service abnormal end.
L520	_P2P1_SVCCNT01	DWord	Indicates P2P parameter 1, 1 Block service normal count.
L522	_P2P1_ERRCNT01	DWord	Indicates P2P parameter 1, 1 Block service abnormal count.
L524~L529	-	Word	P2P parameter 1,2 Block service total.
L530~L535	-	Word	P2P parameter 1,3 Block service total.
L536~L697	-	Word	P2P parameter 1,4~30 Block service total.
L698~L703	-	Word	P2P parameter 1,31 Block service total.

Appendix 1.3 Network Register (N) List

Here describes Network Register for communication (N). P2P parameter: 1~3, P2P block: 0~31

Device	Keyword	Type	Description
N000	_P1B00SN	Word	Saves another station no. of P2P parameter 1, 00 block.
N0000~0004	_P1B00RD1	Word	Saves area device 1 to read P2P parameter 1, 01 block.
N005	_P1B00RS1	Word	Saves area size 1 to read P2P parameter 1, 01 block.
N0006~0009	_P1B00RD2	Word	Saves area device 2 to read P2P parameter 1, 01 block.
N010	_P1B00RS2	Word	Saves area size 2 to read P2P parameter 1, 01 block.
N0011~0014	_P1B00RD3	Word	Saves area device 3 to read P2P parameter 1, 01 block.
N015	_P1B00RS3	Word	Saves area size 3 to read P2P parameter 1, 01 block.
N0016~0019	_P1B00RD4	Word	Saves area device 4 to read P2P parameter 1, 01 block.
N020	_P1B00RS4	Word	Saves area size 4 to read P2P parameter 1, 01 block.
N0021~0024	_P1B00WD1	Word	Saves area device 1 to save P2P parameter 1, 01 block.
N025	_P1B00WS1	Word	Saves area size 1 to save P2P parameter 1, 01 block.
N0026~0029	_P1B00WD2	Word	Saves area device 2 to save P2P parameter 1, 01 block.
N030	_P1B00WS2	Word	Saves area size 2 to save P2P parameter 1, 01 block.
N0031~0034	_P1B00WD3	Word	Saves area device 3 to save P2P parameter 1, 01 block.
N035	_P1B00WS3	Word	Saves area size 3 to save P2P parameter 1, 01 block.
N0036~0039	_P1B00WD4	Word	Saves area device 4 to save P2P parameter 1, 01 block.
N040	_P1B00WS4	Word	Saves area size 4 to save P2P parameter 1, 01 block.
N0041~0081	-	Word	Saving area of P2P parameter 1, 01 block.
N0082~0122	-	Word	Saving area of P2P parameter 1, 02 block. P2P
N0123~1311	-	Word	Saving area of P2P parameter 1, 03~31 block.
N1312~2623	-	Word	Saving area of P2P parameter 2.
N2624~3935	-	Word	Saving area of P2P parameter 3.

Remark

- In XGB series, Network register is available only monitoring. (Read Only)

Appendix 2 Dimension (Unit: mm)

(1) standard type main unit ("S" type)

- XBM-DN16S/32S

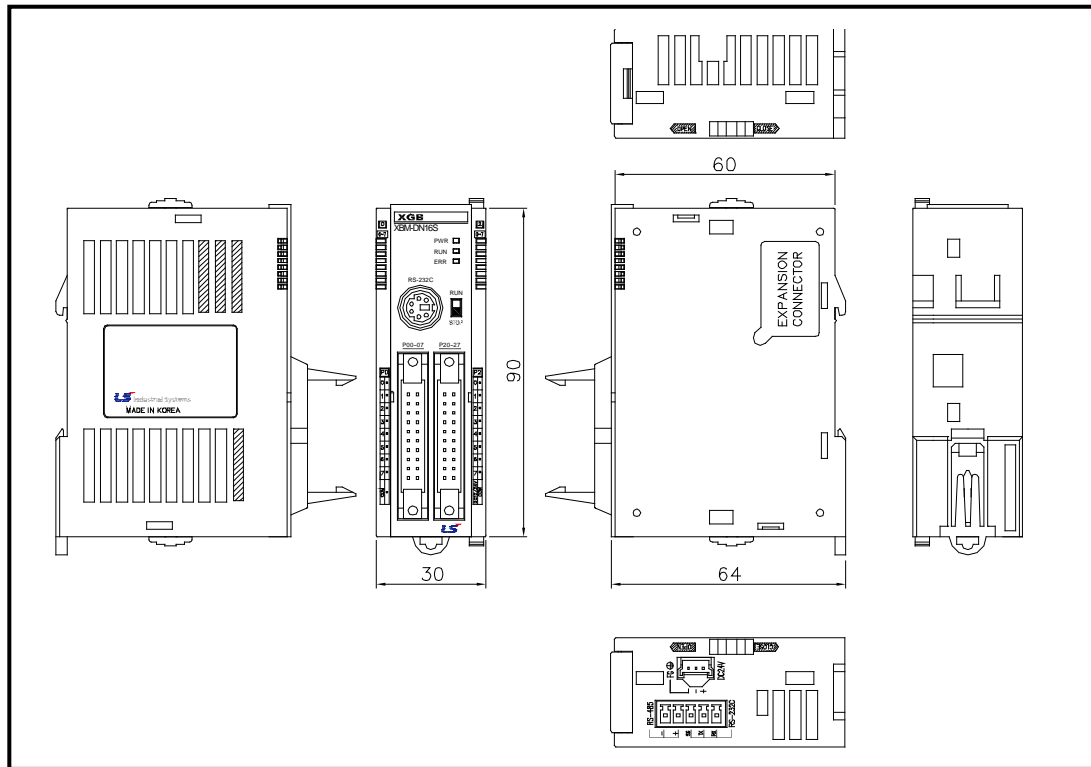

- XBM-DR16S

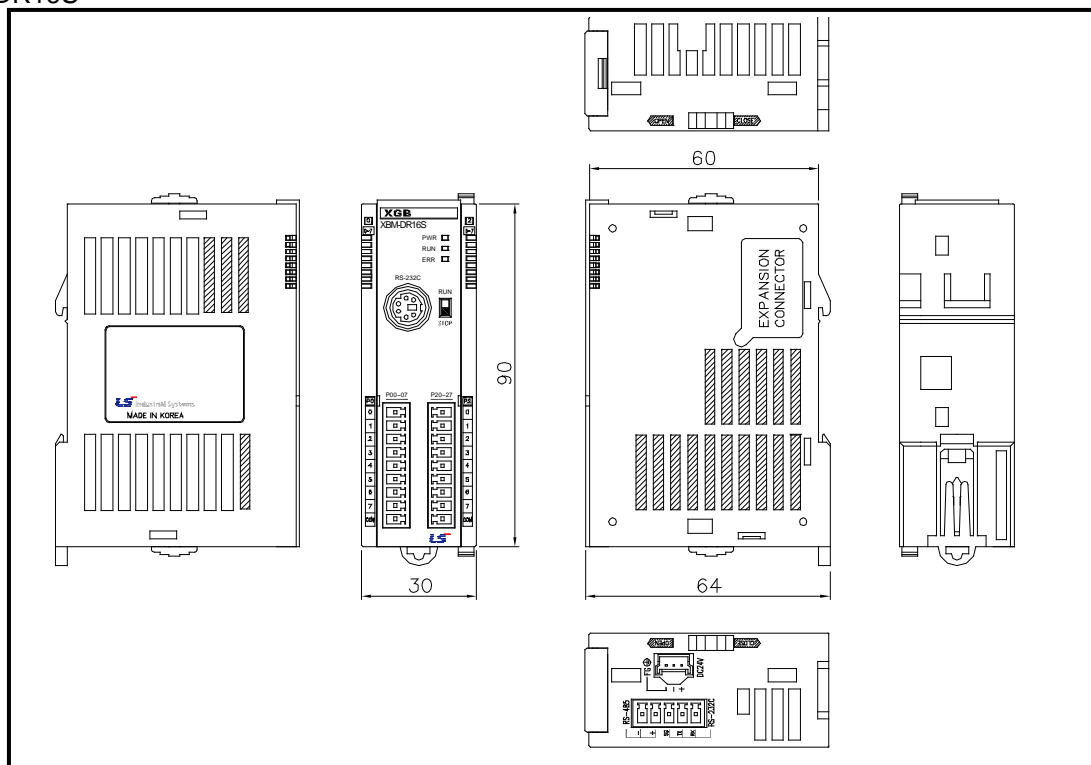

Appendix 2. Dimensions

- XBC-DN64H (/DC)

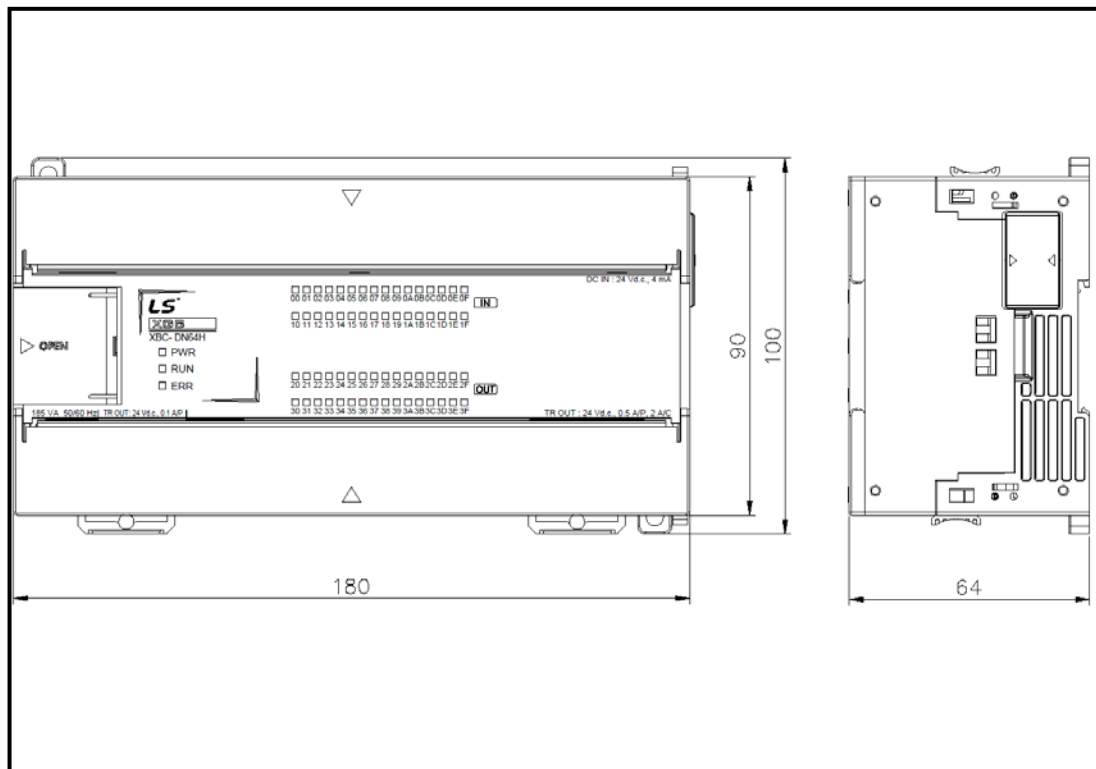

- XBC-DR64H (/DC)

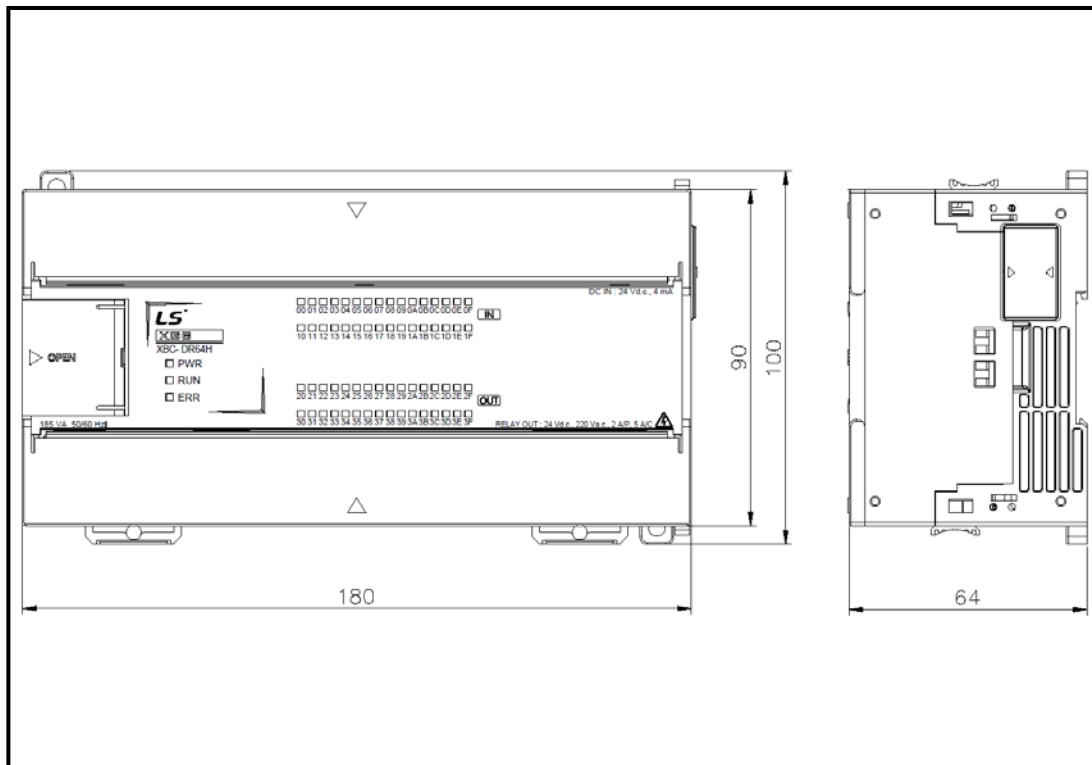

(3) Extension I/O module

- XBE-DC32A, XBE-TN32A, XBE-TP32A, XBE-DN32A

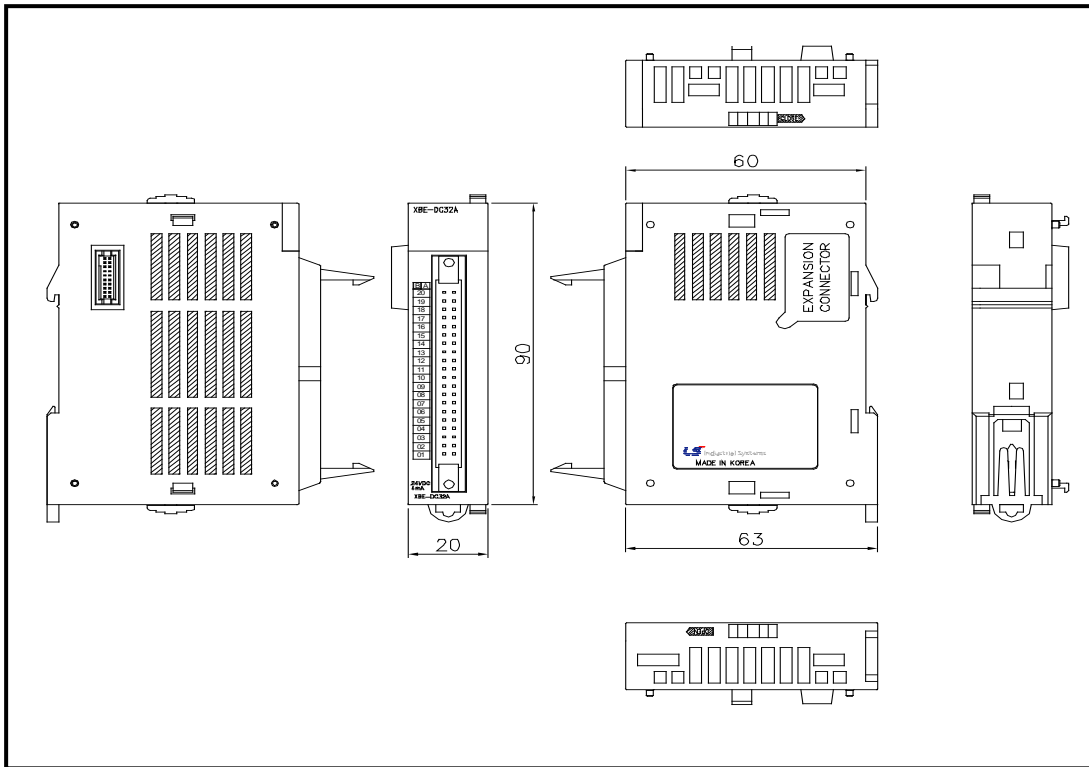

- XBE-RY16A

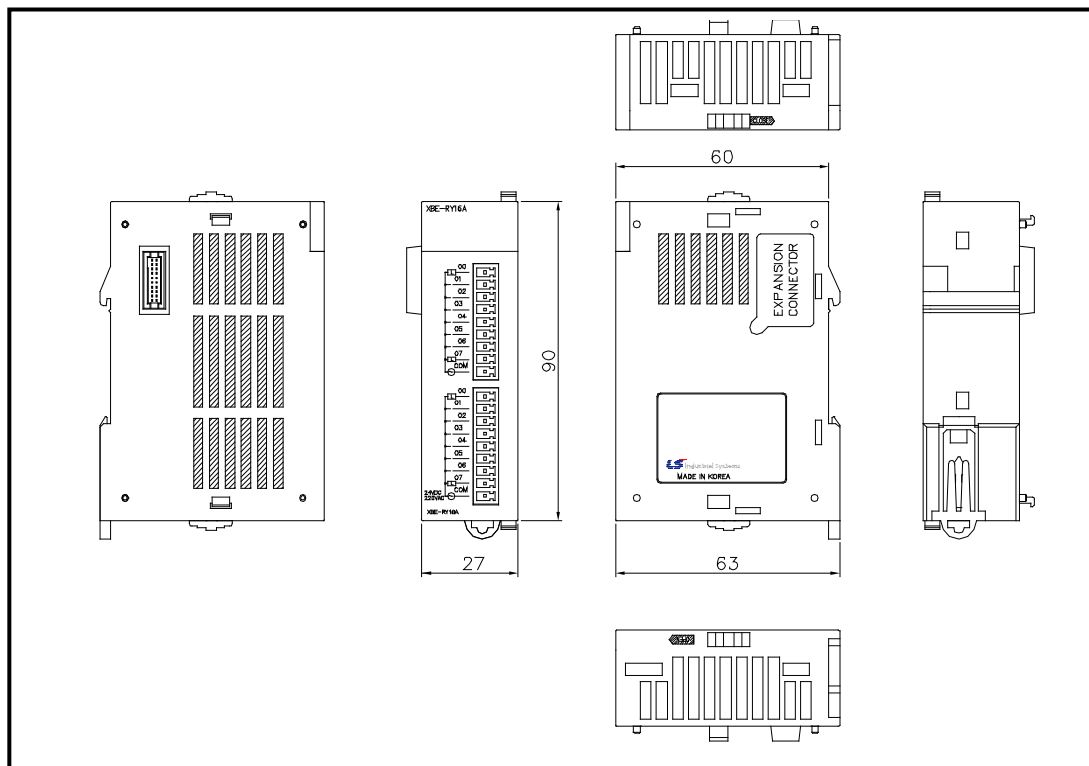

Appendix 2. Dimensions

- XBE-DC08A, XBE-DC16A, XBE-TN08A, XBE-TP08A, XBE-TN16A, XBE-TP16A, XBE-AC08A

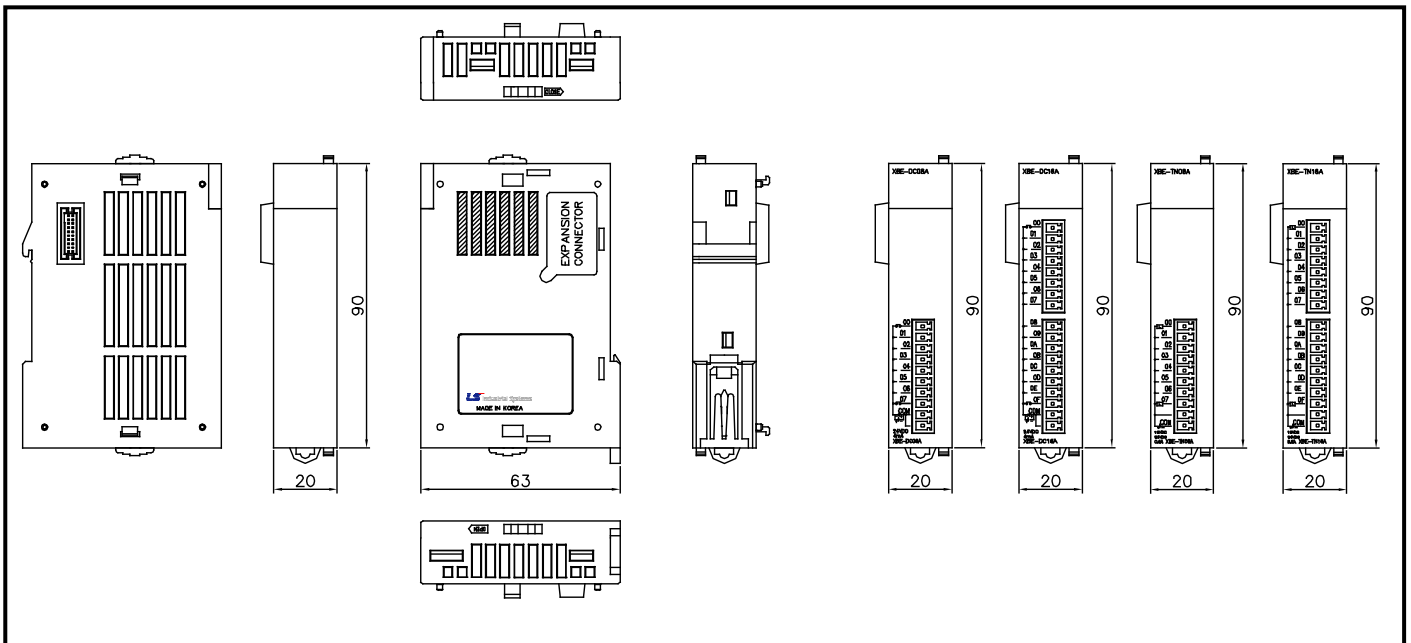

- XBE-DR16A, XBE-RY08A

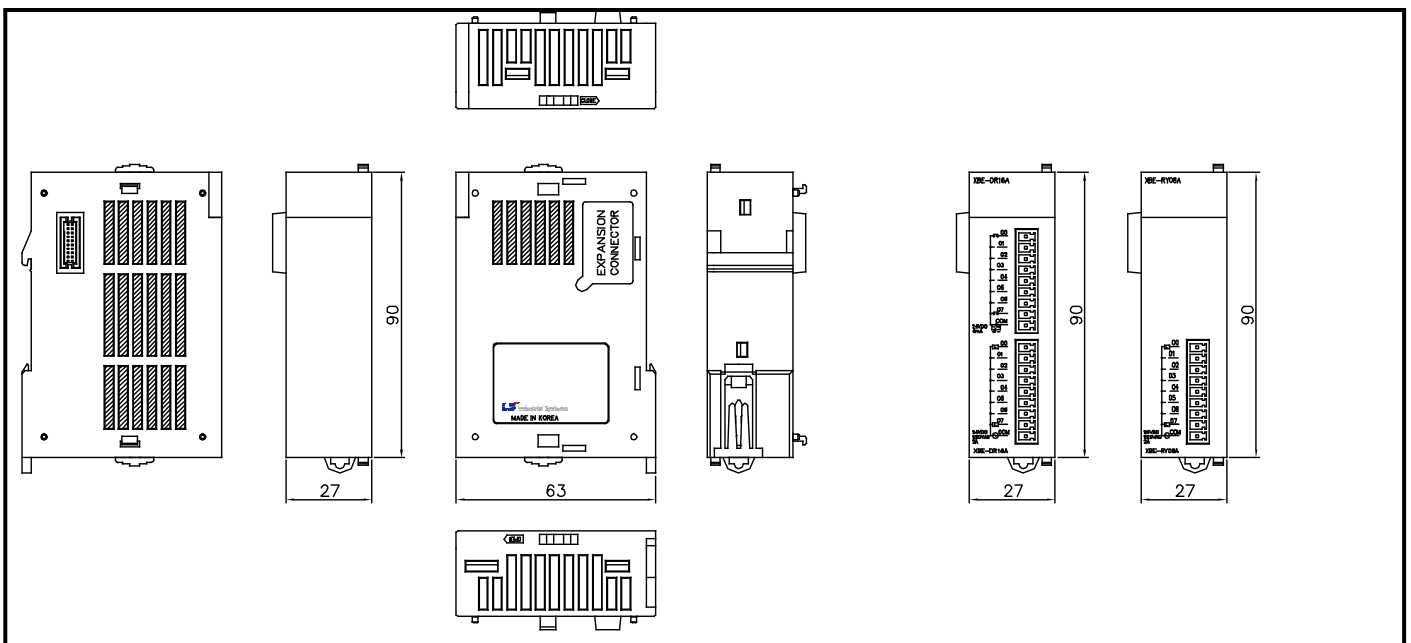

Appendix 3 Compatibility with MASTER-K (Special Relay)

MASTER-K		XGB		
Device	Function	Symbol	Device	Function
F0000	RUN mode	_RUN	F0000	RUN Edit mode
F0001	Program mode	_STOP	F0001	Program mode
F0002	Pause mode	_ERROR	F0002	Error mode
F0003	Debug mode	_DEBUG	F0003	Debug mode
F0004	N/A	_LOCAL_CON	F0006	Remote mode
F0005	N/A	_MODBUS_CON	F0006	Remote mode
F0006	Remote mode	_REMOTE_CON	F0006	Remote mode
F0007	User memory setup	-	F0007	N/A
F0008	N/A	_RUN_EDIT_ST	F0008	Editing during RUN
F0009	N/A	_RUN_EDIT_CHK	F0009	Editing during RUN
F000A	User memory operation	_RUN_EDIT_DONE	F000A	Edit done during RUN
F000B	N/A	_RUN_EDIT_END	F000B	Edit end during RUN
F000C	N/A	_CMOD_KEY	F000C	Operation mode change by KEY
F000D	N/A	_CMOD_LPADT	F000D	Operation mode change by PADT
F000E	N/A	_CMOD_RPADT	F000E	Operation mode change by Remote PADT
F000F	STOP command execution	_CMOD_RLINK	F000F	Operation mode change cause by remote communication module
F0010	Ordinary time On	_FORCE_IN	F0010	Forced input
F0011	Ordinary time Off	_FORCE_OUT	F0011	Forced output
F0012	1 Scan On	_SKIP_ON	F0012	I/O Skip execution
F0013	1 Scan Off	_EMASK_ON	F0013	Error mask execution
F0014	Reversal every Scan	_MON_ON	F0014	Monitor execution
F0015 ~ F001C	N/A	_USTOP_ON	F0015	Stop by Stop Function
		_ESTOP_ON	F0016	Stop by ESTOP Function
		_CONPILE_MODE	F0017	Compile
		_INIT_RUN	F0018	Initialize
		-	F0019 ~ F001F	N/A
		_PB1	F001C	Program Code 1
F001D	N/A	_PB2	F001D	Program Code 2
F001E	N/A	_CB1	F001E	Compile code 1
F001F	N/A	_CB2	F001F	Compile code 2

Appendix 3. Compatibility with MASTER-K

MASTER-K		XGB		
Device	Function	Symbol	Device	Function
F0020	1 Step RUN	_CPU_ER	F0020	CPU configuration error
F0021	Break Point RUN	_IO_TYER	F0021	Module type mismatch error
F0022	Scan RUN	_IO_DEER	F0022	Module detach error
F0023	Contact value match RUN	_FUSE_ER	F0023	Fuse cutoff error
F0024	Word value match RUN	_IO_RWER	F0024	I/O module read/write error
F0025 ~ F002F	N/A	_IP_IFER	F0025	Special/communication module interface error
		_ANNUM_ER	F0026	Heavy error detection of external equipment error
		-	F0027	N/A
		_BPRM_ER	F0028	Basic parameter error
		_IOPRM_ER	F0029	I/O configuration parameter error
		_SPPRM_ER	F002A	Special module parameter error
		_CPPRM_ER	F002B	Communication module parameter error
		_PGM_ER	F002C	Program error
		_CODE_ER	F002D	Program Code error
		_SWDT_ER	F002E	System watchdog error
F0030	Heavy error	_WDT_ER	F0030	Scan watchdog
F0031	Light error	-	F0031	-
F0032	WDT error	-	F0032	-
F0033	I/O combination error	-	F0033	-
F0034	Battery voltage error	-	F0034	-
F0035	Fuse error	-	F0035	-
F0036 ~ F0038	N/A	-	F0036 ~ F0038	-
F0039	Backup normal	-	F0039	-
F003A	Clock data error	-	F003A	-
F003B	Program change	-	F003B	-
F003C	Program change error	-	F003C	-
F003D ~ F003F	N/A	-	F003D ~ F003F	N/A

Appendix 3. Compatibility with MASTER-K

MASTER-K		XGB		
Device	Function	Symbol	Device	Function
F0040~ F005F	N/A	_RTC_ER	F0040	RTC data error
		_DBCK_ER	F0041	Data backup error
		_HBCK_ER	F0042	Hot restart disabled error
		_ABSD_ER	F0043	Abnormal operation stop
		_TASK_ER	F0044	Task collision
		_BAT_ER	F0045	Battery error
		_ANNUM_ER	F0046	Light error detection of external equipment
F0040 ~ F005F	N/A	_LOG_FULL	F0047	Log memory full warning
		_HS_WAR1	F0048	High speed link parameter 1 error
		_HS_WAR2	F0049	High speed link parameter 2 error
		-	F004A ~ F0053	N/A
		_P2P_WAR1	F0054	P2P parameter 1 error
		_P2P_WAR2	F0055	P2P parameter 2 error
		_P2P_WAR3	F0056	P2P parameter 3 error
		-	F0057 ~ F005B	N/A
		_Constant_ER	F005C	Constant error
		-	F005D ~ F005F	N/A
F0060 ~ F006F	Error Code save	-	F0060 ~ F006F	N/A
F0070 ~ F008F	Fuse cutoff save	-	F0070 ~ F008F	N/A
F0090	20ms cycle Clock	_T20MS	F0090	20ms cycle Clock
F0091	100ms cycle Clock	_T100MS	F0091	100ms cycle Clock
F0092	200ms cycle Clock	_T200MS	F0092	200ms cycle Clock
F0093	1s cycle Clock	_T1S	F0093	1s cycle Clock
F0094	2s cycle Clock	_T2S	F0094	2s cycle Clock
F0095	10s cycle Clock	_T10S	F0095	10s cycle Clock
F0096	20s cycle Clock	_T20S	F0096	20s cycle Clock
F0097	60s cycle Clock	_T60S	F0097	60s cycle Clock
F0098 ~F009F	N/A	-	F0098	N/A
		_ON	F0099	Ordinary time On
		_OFF	F009A	Ordinary time Off
		_1ON	F009B	1 Scan On
		_1OFF	F009C	1 Scan Off
		_STOG	F009D	Reversal every Scan
		-	F009B ~ F009F	N/A

Appendix 3. Compatibility with MASTER-K

MASTER-K		XGB		
Device	Function	Symbol	Device	Function
F0100	User Clock 0	-	F0100	User Clock 0
F0101	User Clock 1	-	F0101	User Clock 1
F0102	User Clock 2	-	F0102	User Clock 2
F0103	User Clock 3	-	F0103	User Clock 3
F0104	User Clock 4	-	F0104	User Clock 4
F0105	User Clock 5	-	F0105	User Clock 5
F0106	User Clock 6	-	F0106	User Clock 6
F0107	User Clock 7	-	F0107	User Clock 7
F0108 ~ F010F		-	F0108 ~ F010F	N/A
F0110	Operation error flag	_Ler	F0110	Operation error flag
F0111	Zero flag	_Zero	F0111	Zero flag
F0112	Carry flag	_Carry	F0112	Carry flag
F0113	Full output Off	_All_Off	F0113	Full output Off
F0114	Common RAM R/W error	-	F0114	N/A
F0115	Operation error flag (latch)	_Ler_Latch	F0115	Operation error flag(latch)
F0116 ~ F011F		-	F0116 ~ F011F	N/A
F0120	LT flag	_LT	F0120	LT flag
F0121	LTE flag	_LTE	F0121	LTE flag
F0122	EQU flag	_EQU	F0122	EQU flag
F0123	GT flag	_GT	F0123	GT flag
F0124	GTE flag	_GTE	F0124	GTE flag
F0125	NEQ flag	_NEQ	F0125	NEQ flag
F0126 ~ F012F	N/A	-	F0126 ~ F012F	N/A
F0130~ F013F	AC Down Count	_AC_F_CNT	F0130~ F013F	AC Down Count
F0140~ F014F	FALS no.	_FALS_NUM	F0140~ F014F	FALS no.
F0150~ F015F	PUT/GET error flag	_PUTGET_ERR	F0150~ F030F	PUT/GET error flag
		CPU TYPE	F0440 ~ F044F	CPU TYPE
		CPU VERSION	F0450 ~ F045F	CPU VERSION
		OS version no.	F0460 ~ F047F	System OS version no.
F0160~ F049F	N/A	OS date	F0480 ~ F049F	System OS DATE

Appendix 3. Compatibility with MASTER-K

MASTER-K		XGB		
Device	Function	Symbol	Device	Function
F0500~ F050F	Max. Scan time	_SCAN_MAX	F0500~ F050F	Max. Scan time
F0510~ F051F	Min. Scan time	_SCAN_MIN	F0510~ F051F	Min. Scan time
F0520~ F052F	Current Scan time	_SCAN_CUR	F0520~ F052F	Current Scan time
F0530~ F053F	Clock data (year/month)	_YEAR_MON	F0530~ F053F	Clock data (year/month)
F0540~ F054F	Clock data (day/hr)	_DAY_TIME	F0540~ F054F	Clock data(day/hr)
F0550~ F055F	Clock data (min/sec)	_MIN_SEC	F0550~ F055F	Clock data(min/sec)
F0560~ F056F	Clock data (100year/weekday)	_HUND_WK	F0560~ F056F	Clock data(100year/weekday)
F0570~ F058F	N/A	_FPU_LFlag_I	F0570	-
		_FPU_LFlag_U	F0571	-
		_FPU_LFlag_O	F0572	-
		_FPU_LFlag_Z	F0573	-
		_FPU_LFlag_V	F0574	-
		-	F0575 ~ F0579	N/A
		_FPU_Flag_I	F057A	-
		_FPU_Flag_U	F057B	-
		_FPU_Flag_O	F057C	-
		_FPU_Flag_Z	F057D	-
		_FPU_Flag_V	F057E	-
		_FPU_Flag_E	F057F	-
	Error Step	F0580~ F058F	Error step save	
F0590~ F059F	Error step save	-	F0590~ F059F	N/A
F0600~ F060F	FMM detailed error information	_REF_COUNT	F060~F061	Refresh Count
F0610~ F063F	N/A	_REF_OK_CNT	F062~F063	Refresh OK Count
		_REF_NG_CNT	F064~F065	Refresh NG Count
		_REF_LIM_CNT	F066~F067	Refresh Limit Count
		_REF_ERR_CNT	F068~F069	Refresh Error Count
		_MOD_RD_ERR_CNT	F070~F071	MODULE Read Error Count
		_MOD_WR_ERR_CNT	F072~F073	MODULE Write Error Count
		_CA_CNT	F074~F075	Cmd Access Count
		_CA_LIM_CNT	F076~F077	Cmd Access Limit Count
		_CA_ERR_CNT	F078~F079	Cmd Access Error Count
	_BUF_FULL_CNT	F080~F081	Buffer Full Count	

Appendix 4 Instruction List

Appendix 4.1 Classification of Instructions

Classification	Instructions	Details	Remarks
Basic Instructions	Contact Point Instruction	LOAD, AND, OR related Instructions	
	Unite Instruction	AND LOAD, OR LOAD, MPUSH, MLOAD, MPOP	
	Reverse Instruction	NOT	
	Master Control Instruction	MCS, MCSCLR	
	Output Instruction	OUT, SET, RST, 1 Scan Output Instruction, Output Reverse Instruction (FF)	
	Sequence/Last-input Preferred Instruction	Step Control Instruction (SET Sxx.xx, OUT Sxx.xx)	
	End Instruction	END	
	Non-Process Instruction	NOP	
	Timer Instruction	TON, TOFF, TMR, TMON, TRTG	
	Counter Instruction	CTD, CTU, CTUD, CTR	
Application Instructions	Data Transfer Instruction	Transfers specified Data, Group, String	4/8/64 Bits available
	Conversion Instruction	Converts BIN/BCD of specified Data & Group	4/8 Bits available
	Data Type Conversion Instruction	Converts Integer/Real Number	
	Output Terminal Compare Instruction	Saves compared results in special relay	Compare to Unsigned
	Input Terminal Compare Instruction	Saves compared results in BR. Compares Real Number, String & Group. Compares 3 Operands	Compare to Signed
	Increase/Decrease Instruction	Increases or decreases specified data 1 by 1	4/8 Bits available
	Rotate Instruction	Rotates specified data to the left and right, including Carry	4/8 Bits available
	Move Instruction	Moves specified data to the left and right, word by word, bit by bit	4/8 Bits available
	Exchange Instruction	Exchanges between devices, higher & lower byte, group data	
	BIN Operation Instruction	Addition, Subtraction, Multiplication & Division for Integer/ Real Number, Addition for String, Addition & Subtraction for Group	
	BCD Operation Instruction	Addition, Subtraction, Multiplication, Division.	
	Logic Operation Instruction	Logic Multiplication, Logic Addition, Exclusive OR, Exclusive NOR, Group Operation	
	System Instruction	Error Display, WDT Initialize, Output Control, Operation Stop, etc.	
	Data Process Instruction	Encode, Decode, Data Disconnect/Connect, Search, Align, Max., Min., Total, Average, etc.	
	Data Table Process Instruction	Data Input/Output of Data Table	
	String Process Instruction	String related Convert, Comment Read, String Extract, ASCII Convert, HEX Convert, String Search, etc.	
	Special Function Instruction	Trigonometric Function, Exponential/Log Function, Angle/Radian Convert, etc.	
	Data Control Instruction	Max/Min Limit Control, Dead-zone Control, Zone Control	
	Time related Instruction	Date Time Data Read/Write, Time Data Adjust & Convert	
	Diverge Instruction	JMP, CALL	
	Loop Instruction	FOR/NEXT/BREAK	
	Flag related Instruction	Carry Flag Set/Reset, Error Flag Clear	
Special/Communication related Instruction	Data Read/Write by BUSCON Direct Access		
Interrupt related Instruction	Interrupt Enable/Disable		
Signal Reverse Instruction	Reverse Integer/Real Signals, Absolute Value Operation		

Appendix 4.2 Basic Instructions

1) Contact point instruction

Classification	Designations	Symbol	Description	Support	
				XGK	XGB
Contact Point	LOAD		A Contact Point Operation Start	○	○
	LOAD NOT		B Contact Point Operation Start	○	○
	AND		A Contact Point Series-Connected	○	○
	AND NOT		B Contact Point Series-Connected	○	○
	OR		A Contact Point Parallel-Connected	○	○
	OR NOT		B Contact Point Parallel-Connected	○	○
	LOADP		Positive Convert Detected Contact Point	○	○
	LOADN		Negative Convert Detected Contact Point	○	○
	ANDP		Positive Convert Detected Contact Point Series-	○	○
	ANDN		Negative Convert Detected Contact Point Series-	○	○
	ORP		Positive Convert Detected Contact Point Parallel-	○	○
	ORN		Negative Convert Detected Contact Point Parallel-	○	○

2) Union instruction

Classification	Designations	Symbol	Description	Support	
				XGK	XGB
Unite	AND LOAD		A,B Block Series-Connected	○	○
	OR LOAD		A,B Block Parallel-Connected	○	○
	MPUSH		Operation Result Push up to present	○	○
	MLOAD		Operation Result Load Previous to Diverge Point	○	○
	MPOP		Operation Result Pop Previous to Diverge Point	○	○

Appendix 4 Instruction List



3) Reverse instruction

Classification	Designations	Symbol	Description	Support	
				XGK	XGB
Reverse	NOT		Previous Operation results Reverse	○	○

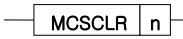
4) Master Control instruction

Classification	Designations	Symbol	Description	Support	
				XGK	XGB
Master Control	MCS		Master Control Setting (n:0~7)	○	○
	MCSCLR		Master Control Cancel (n:0~7)	○	○

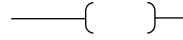
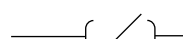
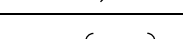
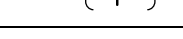
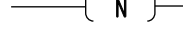
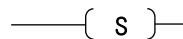
5) Output instruction

Classification	Designations	Symbol	Description	Support	
				XGK	XGB
Output	OUT		Operation Results Output	○	○
	OUT NOT		Operation Results Reverse Output	○	○
	OUTP		1 Scan Output if Input Condition rises	○	○
	OUTN		1 Scan Output if Input Condition falls	○	○
	SET		Contact Point Output ON kept	○	○
	RST		Contact Point Output OFF kept	○	○
	FF		Output Reverse if Input Condition rises	○	○

6) Sequence/Last-input preferred instruction

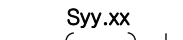
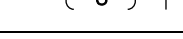
Classification	Designations	Symbol	Description	Support	
				XGK	XGB
Step Control	SET S		Sequence Control	○	○
	OUT S		Last-input Preferred	○	○

7) End instruction

Classification	Designations	Symbol	Description	Support	
				XGK	XGB
End	END		Program End	○	○

8) Non-process instruction

Classification	Designations	Symbol	Description	Support	
				XGK	XGB
Non-Process	NOP	Ladder not displayed	Non-Process Instruction, used in Nimonic	○	○

9) Timer instruction

Classification	Designations	Symbol	Description	Support	
				XGK	XGB
Timer	TON			○	○
	TOFF			○	○
	TMR			○	○
	TMON			○	○
	TRTG			○	○

10) Counter instruction

Classification	Designations	Symbol	Description	Support	
				XGK	XGB
Counter	CTD			○	○
	CTU			○	○
	CTUD			○	○
	CTR			○	○

Appendix 4.3 Application Instruction

1) Data transfer instruction

Classification	Designations	Symbol	Description	Support	
				XGK	XGB
16 bits Transfer	MOV		(S) → (D)	○	○
	MOV _P				
32 bits Transfer	DMOV		(S+1,S) → (D+1,D)	○	○
	DMOV _P				
Short Real Number Transfer	RMOV		(S+1,S) → (D+1,D)	○	○
	RMOV _P				
Long Real Number Transfer	LMOV		(S+3,S+2,S+1,S) → (D+3,D+2,D+1,D)	○	○
	LMOV _P				
4 bits Transfer	MOV ₄			○	○
	MOV _{4P}				
8 bits Transfer	MOV ₈			○	○
	MOV _{8P}				
1's complement Transfer	CMOV		1's complement (S) → (D)	○	○
	CMOV _P				
	DCMOV		1's complement (S+1,S) → (D+1,D)	○	○
	DCMOV _P				
16 bits Group Transfer	GMOV			○	○
	GMOV _P				
Multiple Transfer	FMOV			○	○
	FMOV _P				
Specified Bits Transfer	BMOV			○	○
	BMOV _P				
Specified Bits Group Transfer	GBMOV			○	○
	GBMOV _P				

1) Data Transfer Instruction (continued)

Classification	Designations	Symbol	Description	Support	
				XGK	XGB
String Transfer	\$MOV	$\boxed{\text{\$MOV}} \quad \boxed{S} \quad \boxed{D}$	String started from (S) → String started from (D)	○	○
	\$MOVP	$\boxed{\text{\$MOVP}} \quad \boxed{S} \quad \boxed{D}$		○	○

2) BCD/BIN conversion instruction

Classification	Designations	Symbol	Description	Support		
				XGK	XGB	
BCD Conversion	BCD	$\boxed{\text{BCD}} \quad \boxed{S} \quad \boxed{D}$	(S) $\xrightarrow{\text{To BCD}}$ (D) ↑ BIN(0~9999)	○	○	
	BCDP	$\boxed{\text{BCDP}} \quad \boxed{S} \quad \boxed{D}$				
	DBCDCD	$\boxed{\text{DBCDCD}} \quad \boxed{S} \quad \boxed{D}$	(S+1,S) $\xrightarrow{\text{To BCD}}$ (D+1,D) ↑ BIN(0~99999999)	○	○	
	DBCDCP	$\boxed{\text{DBCDCP}} \quad \boxed{S} \quad \boxed{D}$				
4/8 Bits BCD Conversion	BCD4	$\boxed{\text{BCD4}} \quad \boxed{Sb} \quad \boxed{Db}$	(Sb):Bit, BIN(0~9) b15 $\xrightarrow{\text{To 4bit BCD}}$ b0 ↑ (Db): Bit	○	○	
	BCD4P	$\boxed{\text{BCD4P}} \quad \boxed{Sb} \quad \boxed{Db}$				
	BCD8	$\boxed{\text{BCD8}} \quad \boxed{Sb} \quad \boxed{Db}$	(Sb):Bit, BIN(0~99) b15 $\xrightarrow{\text{To 8bit BCD}}$ b0 ↑ (Db):Bit	○	○	
	BCD8P	$\boxed{\text{BCD8P}} \quad \boxed{Sb} \quad \boxed{Db}$				
BIN Conversion	BIN	$\boxed{\text{BIN}} \quad \boxed{S} \quad \boxed{D}$	(S) $\xrightarrow{\text{To BIN}}$ (D) ↑ BCD(0~9999)	○	○	
	BINP	$\boxed{\text{BINP}} \quad \boxed{S} \quad \boxed{D}$				
	DBIN	$\boxed{\text{DBIN}} \quad \boxed{S} \quad \boxed{D}$	(S+1,S) $\xrightarrow{\text{To BIN}}$ (D+1,D) ↑ BCD(0~99999999)	○	○	
	DBINP	$\boxed{\text{DBINP}} \quad \boxed{S} \quad \boxed{D}$				
4/8 Bits BIN Conversion	BIN4	$\boxed{\text{BIN4}} \quad \boxed{Sb} \quad \boxed{Db}$	(Sb):Bit, BCD(0~9) b15 $\xrightarrow{\text{To 4bit BIN}}$ b0 ↑ (Db):Bit	○	○	
	BIN4P	$\boxed{\text{BIN4P}} \quad \boxed{Sb} \quad \boxed{Db}$				
	BIN8	$\boxed{\text{BIN8}} \quad \boxed{Sb} \quad \boxed{Db}$	(Sb):Bit, BCD(0~99) b15 $\xrightarrow{\text{To bit BIN}}$ b0 ↑ (Db):Bit	○	○	
	BIN8P	$\boxed{\text{BIN8P}} \quad \boxed{Sb} \quad \boxed{Db}$				
Group BCD,BIN Conversion	GBCD	$\boxed{\text{GBCD}} \quad \boxed{S} \quad \boxed{D} \quad \boxed{N}$	□ Data (S) to N converted to BCD, and (D) to N saved	○	○	
	GBCDP	$\boxed{\text{GBCDP}} \quad \boxed{S} \quad \boxed{D} \quad \boxed{N}$				
	GBIN	$\boxed{\text{GBIN}} \quad \boxed{S} \quad \boxed{D} \quad \boxed{N}$		□ Data (S) to N converted to BIN, and (D) to N saved	○	○
	GBINP	$\boxed{\text{GBINP}} \quad \boxed{S} \quad \boxed{D} \quad \boxed{N}$				

3) Data type conversion instruction

Classification	Designations	Symbol	Description	Support	
				XGK	XGB
16 Bits Integer/Real Conversion	I2R	$\boxed{\text{I2R}} \quad \boxed{\text{S}} \quad \boxed{\text{D}}$	(S) $\xrightarrow{\text{To Real}}$ (D+1,D) \uparrow Int(-32768~32767)	○	○
	I2RP	$\boxed{\text{I2RP}} \quad \boxed{\text{S}} \quad \boxed{\text{D}}$			
	I2L	$\boxed{\text{I2L}} \quad \boxed{\text{S}} \quad \boxed{\text{D}}$	(S) $\xrightarrow{\text{To Long}}$ (D+3,D+2,D+1,D) \uparrow Int(-32768~32767)	○	○
	I2LP	$\boxed{\text{I2LP}} \quad \boxed{\text{S}} \quad \boxed{\text{D}}$			
32 Bits Integer/Real Conversion	D2R	$\boxed{\text{D2R}} \quad \boxed{\text{S}} \quad \boxed{\text{D}}$	(S+1,S) $\xrightarrow{\text{To Real}}$ (D+1,D) \uparrow Dint(-2147483648~2147483647)	○	○
	D2RP	$\boxed{\text{D2RP}} \quad \boxed{\text{S}} \quad \boxed{\text{D}}$			
	D2L	$\boxed{\text{D2L}} \quad \boxed{\text{S}} \quad \boxed{\text{D}}$	(S+1,S) $\xrightarrow{\text{To Long}}$ (D+3,D+2,D+1,D) \uparrow Dint(-2147483648~2147483647)	○	○
	D2LP	$\boxed{\text{D2LP}} \quad \boxed{\text{S}} \quad \boxed{\text{D}}$			
Short Real/Integer Conversion	R2I	$\boxed{\text{R2I}} \quad \boxed{\text{S}} \quad \boxed{\text{D}}$	(S+1,S) $\xrightarrow{\text{To INT}}$ (D) \uparrow Whole Sing Real Range	○	○
	R2IP	$\boxed{\text{R2IP}} \quad \boxed{\text{S}} \quad \boxed{\text{D}}$			
	R2D	$\boxed{\text{R2D}} \quad \boxed{\text{S}} \quad \boxed{\text{D}}$	(S+1,S) $\xrightarrow{\text{To DINT}}$ (D+1,D) \uparrow Whole Sing Real Range	○	○
	R2DP	$\boxed{\text{R2DP}} \quad \boxed{\text{S}} \quad \boxed{\text{D}}$			
Long Real/Integer Conversion	L2I	$\boxed{\text{L2I}} \quad \boxed{\text{S}} \quad \boxed{\text{D}}$	(S+3,S+2,S+1,S) $\xrightarrow{\text{To INT}}$ (D) \uparrow Whole Double Real Range	○	○
	L2IP	$\boxed{\text{L2IP}} \quad \boxed{\text{S}} \quad \boxed{\text{D}}$			
	L2D	$\boxed{\text{L2D}} \quad \boxed{\text{S}} \quad \boxed{\text{D}}$	(S+3,S+2,S+1,S) $\xrightarrow{\text{To DINT}}$ (D+1,D) \uparrow Whole Double Real Range	○	○
	L2DP	$\boxed{\text{L2DP}} \quad \boxed{\text{S}} \quad \boxed{\text{D}}$			

Remark

1) Integer value and Real value will be saved respectively in quite different format. For such reason, Real Number Data should be converted as applicable before used for Integer Operation.

4) Comparison instruction

Classification	Designations	Symbol	Description	Support	
				XGK	XGB
Unsigned Compare with Special Relay used	CMP		CMP(S1,S2) and applicable Flag SET (S1, S2 is Word)	○	○
	CMPP				
	DCMP		CMP(S1,S2) and applicable Flag SET (S1, S2 is Double Word)	○	○
	DCMPP				
4/8 Bits Compare	CMP4		CMP(S1,S2) and applicable Flag SET (S1, S2 is Nibble)	○	○
	CMP4P				
	CMP8		CMP(S1,S2) and applicable Flag SET (S1, S2 is Byte)	○	○
	CMP8P				
Table Compare	TCMP		CMP(S1,S2)) CMP(S1+15,S2+15) Result:(D) ~ (D+15), 1 if identical	○	○
	TCMPP				
	DTCMP		CMP((S1+1,S1),(S2+1,S2)) CMP((S1+31,S1+30),(S2+31,S2+30)) Result:(D) ~ (D+15)	○	○
	DTCMPP				
Group Compare (16 Bits)	GEQ		Compares S1 data to S2 data word by word, and saves its result in Device (D) bit by bit from the lower bit (N ≤ 16)	○	○
	GEQP				
	GGT				
	GGTP				
	GLT				
	GLTP				
	GGE				
	GGEP				
	GLE				
	GLEP				
	GNE				
	GNEP				

Remark

1) CMP(P), DCMP(P), CMP4(P), CMP8(P), TCMP(P) & DTCMP(P) Instructions all process the results of Unsigned Compare. All the other Compare Instructions will perform Signed Compare.

4) Comparison instruction (continued)

Classification	Designations	Symbol	Description	Support	
				XGK	XGB
Group Compare (32 Bits)	GDEQ	$\text{---} \boxed{\text{GDEQ}} \boxed{\text{S1}} \boxed{\text{S2}} \boxed{\text{D}} \boxed{\text{N}} \text{---}$	Compares S1 data to S2 data 2 by 2 words, and saves its result in Device (D) bit by bit from the lower bit ($N \leq 16$)	○	○
	GDEQP	$\text{---} \boxed{\text{GDEQP}} \boxed{\text{S1}} \boxed{\text{S2}} \boxed{\text{D}} \boxed{\text{N}} \text{---}$		○	○
	GDGT	$\text{---} \boxed{\text{GDGT}} \boxed{\text{S1}} \boxed{\text{S2}} \boxed{\text{D}} \boxed{\text{N}} \text{---}$		○	○
	GDGTP	$\text{---} \boxed{\text{GDGTP}} \boxed{\text{S1}} \boxed{\text{S2}} \boxed{\text{D}} \boxed{\text{N}} \text{---}$		○	○
	GDLT	$\text{---} \boxed{\text{GDLT}} \boxed{\text{S1}} \boxed{\text{S2}} \boxed{\text{D}} \boxed{\text{N}} \text{---}$		○	○
	GDLTP	$\text{---} \boxed{\text{GDLTP}} \boxed{\text{S1}} \boxed{\text{S2}} \boxed{\text{D}} \boxed{\text{N}} \text{---}$		○	○
	GDGE	$\text{---} \boxed{\text{GDGE}} \boxed{\text{S1}} \boxed{\text{S2}} \boxed{\text{D}} \boxed{\text{N}} \text{---}$		○	○
	GDGEP	$\text{---} \boxed{\text{GDGEP}} \boxed{\text{S1}} \boxed{\text{S2}} \boxed{\text{D}} \boxed{\text{N}} \text{---}$		○	○
	GDLE	$\text{---} \boxed{\text{GDLE}} \boxed{\text{S1}} \boxed{\text{S2}} \boxed{\text{D}} \boxed{\text{N}} \text{---}$		○	○
	GDLEP	$\text{---} \boxed{\text{GDLEP}} \boxed{\text{S1}} \boxed{\text{S2}} \boxed{\text{D}} \boxed{\text{N}} \text{---}$		○	○
	GDNE	$\text{---} \boxed{\text{GDNE}} \boxed{\text{S1}} \boxed{\text{S2}} \boxed{\text{D}} \boxed{\text{N}} \text{---}$		○	○
	GDNEP	$\text{---} \boxed{\text{GDNEP}} \boxed{\text{S1}} \boxed{\text{S2}} \boxed{\text{D}} \boxed{\text{N}} \text{---}$		○	○

4) Comparison instruction (continued)

Classification	Designations	Symbol	Description	Support	
				XGK	XGB
16 Bits Data Compare (LOAD)	LOAD=		Compares (S1) to (S2), and saves its result in Bit Result(BR) (Signed Operation)	○	○
	LOAD>				
	LOAD<				
	LOAD>=				
	LOAD<=				
	LOAD<>				
16 Bits Data Compare (AND)	AND=		Performs AND operation of (S1) & (S2) Compare Result and Bit Result (BR), and then saves its result in BR (Signed Operation)	○	○
	AND>				
	AND<				
	AND>=				
	AND<=				
	AND<>				
16 Bits Data Compare (OR)	OR=		Performs OR operation of (S1) & (S2) Compare Result and Bit Result (BR), and then saves its result in BR (Signed Operation)	○	○
	OR<=				
	OR<>				
32 Bits Data Compare (LOAD)	LOADD=		Compares (S1) to (S2), and saves its result in Bit Result(BR) (Signed Operation)		
	LOADD>				
	LOADD<				
	LOADD>=				
	LOADD<=				
	LOADD<>				



Remark

Comparison instruction for input process the result of Signed comparison instruction generally. To process Unsigned comparison, Use comparison instruction for input.

4) Comparison instruction (continued)

Classification	Designations	Symbol	Description	Support	
				XGK	XGB
32 Bits Data Compare (AND)	ANDD=		Performs AND operation of (S1) & (S2) Compare Result and Bit Result (BR), and then saves its result in BR (Signed Operation)	○	○
	ANDD>				
	ANDD<				
	ANDD>=				
	ANDD<=				
	ANDD<>				
32bt Data Compare (OR)	ORD=		Performs OR operation of (S1) & (S2) Compare Result and Bit Result (BR), and then saves its result in BR (Signed Operation)	○	○
	ORD>				
	ORD<				
	ORD>=				
	ORD<=				
	ORD<>				
Short Real Number Compare (LOAD)	LOADR=		Performs OR operation of (S1) & (S2) Compare Result and Bit Result (BR), and then saves its result in BR (Signed Operation)	○	○
	LOADR>				
	LOADR<				
	LOADR>=				
	LOADR<=				
	LOADR<>				
Short Real Number Compare (AND)	ANDR=		Compares (S1+1,S) to (S2+1,S2) and saves its result in Bit Result (BR) (Signed Operation)	○	○
	ANDR>				
	ANDR<				
	ANDR>=				
	ANDR<=				
	ANDR<>				

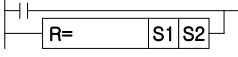
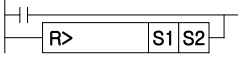
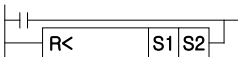
4) Comparison instruction (continued)

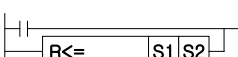
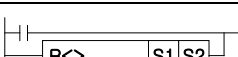
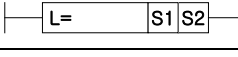
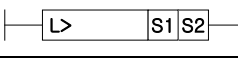
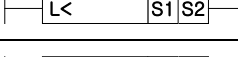
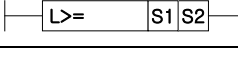
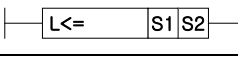
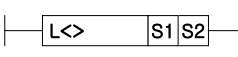
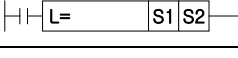
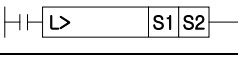
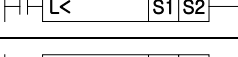
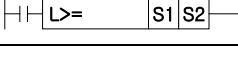
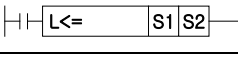
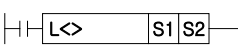
Classification	Designations	Symbol	Description	Support	
				XGK	XGB
Real Number Compare (OR)	ORR=		Compares (S1+1,S1) to (S2+1,S2) and saves its result in Bit Result (BR) (Signed Operation)	○	○
	ORR>				
	ORR<				
	ORR>=				
	ORR<=				
	ORR<>				
Long Real Number Compare (LOAD)	LOADL=		Compares (S1+3,S1+2,S1+1,S) to (S2+3,S2+2, S2+1,S2) and saves its result in Bit Result(BR) (Signed Operation)	○	○
	LOADL>				
	LOADL<				
	LOADL>=				
	LOADL<=				
	LOADL<>				
Long Real Number Compare (AND)	ANDL=		Performs AND operation of (S1+1,S1) & (S2+1,S2) Compare Result and Bit Result(BR), and then saves its result in BR (Signed Operation)	○	○
	ANDL>				
	ANDL<				
	ANDL>=				
	ANDL<=				
	ANDL<>				

4) Comparison instruction (continued)

Classification	Designations	Symbol	Description	Support	
				XGK	XGB
Double Real Number Compare (OR)	ORL=		Performs OR operation of (S1 +1,S1) & (S2+1,S2) Compare Result and Bit Result(BR), and then saves its result in BR (Signed Operation)	○	○
	ORL>				
	ORL<				
	ORL>=				
	ORL<=				
	ORL<>				
String Compare (LOAD)	LOAD\$=		Compares (S1) to (S2) Starting String and saves its result in Bit Result(BR)	○	○
	LOAD\$>				
	LOAD\$<				
	LOAD\$>=				
	LOAD\$<=				
	LOAD\$<>				
String Compare (AND)	AND\$=		Performs AND operation of (S 1) & (S2) Starting String Compare Result and Bit Result(BR), and then saves its result in BR	○	○
	AND\$>				
	AND\$<				
	AND\$>=				
	AND\$<=				
	AND\$<>				

4) Comparison instruction (continued)

Classification	Designations	Symbol	Description	Support	
				XGK	XGB
String Compare (OR)	OR\$=		Performs OR operation of (S1) & (S2) Starting String Compare Result and Bit Result(BR), and then saves its result in BR	○	○
	OR\$>				
	OR\$<				
	OR\$>=				
	OR\$<=				
	OR\$<>				
16 Bits Data Group Compare (LOAD)	LOADG=		Compares (S1), (S1+1), ..., (S1+N) to (S2), (S2+1), ..., (S2+N) 1 to 1, and then saves 1 in Bit Result(BR) if each value compared meets given condition	○	○
	LOADG>				
	LOADG<				
	LOADG>=				
	LOADG<=				
	LOADG<>				
16 Bits Data Group Compare (AND)	ANDG=		Performs AND operation of (S1), (S1+1), ..., (S1+N) & (S2), (S2+1), ..., (S2+N) 1 to 1 Compare Result and Bit Result (BR), and then saves its result in BR	○	○
	ANDG>				
	ANDG<				
	ANDG>=				
	ANDG<=				
	ANDG<>				
16 Bits Data Group Compare (OR)	ORG=		Performs OR operation of (S1), (S1+1), ..., (S1+N) & (S2), (S2+1), ..., (S2+N) 1 to 1 Compare Result and Bit Result (BR), and then saves its result in BR	○	○
	ORG>				
	ORG<				
	ORG>=				
	ORG<=				
	ORG<>				

4) Comparison instruction (continued)

Classification	Designations	Symbol	Description	Support	
				XGX	XGB
32 Bits Data Group Compare (LOAD)	LOADDG=		Compares (S1), (S1+1), ..., (S1+N) to (S2), (S2+1), ..., (S2+N) 1 to 1, and then saves 1 in Bit Result(BR) if each value compared meets given condition	○	○
	LOADDG>				
	LOADDG<				
	LOADDG>=				
	LOADDG<=				
	LOADDG<>				
32 Bits Data Group Compare (AND)	ANDDG=		Performs AND operation of (S1), (S1+1), ..., (S1+N) & (S2), (S2+1), ..., (S2+N) 1 to 1 Compare Result and Bit Result(BR), and then saves its result in BR	○	○
	ANDDG>				
	ANDDG<				
	ANDDG>=				
	ANDDG<=				
	ANDDG<>				
32 Bits Data Group Compare (OR)	ORDG=		Performs OR operation of (S1), (S1+1), ..., (S1+N) & (S2), (S2+1), ..., (S2+N) 1 to 1 Compare Result and Bit Result(BR), and then saves its result in BR	○	○
	ORDG>				
	ORDG<				
	ORDG>=				
	ORDG<=				
	ORDG<>				

4) Comparison instruction (continued)

Classification	Designations	Symbol	Description	Support	
				XGK	XGB
Three 16-Bit Data Compare (LOAD)	LOAD3=		Saves 1 in Bit Result(BR) if each value of (S1), (S2), (S3) meets given condition	○	○
	LOAD3>				
	LOAD3<				
	LOAD3>=				
	LOAD3<=				
	LOAD3<>				
Three 16-Bit Data Compare (AND)	AND3=		Performs AND operation of (S1), (S2), (S3) Compare Result by given condition and Bit Result (BR), and then saves its result in BR	○	○
	AND3>				
	AND3<				
	AND3>=				
	AND3<=				
	AND3<>				
Three 32-Bit Data Compare (OR)	OR3=		Performs OR operation of (S1), (S2), (S3) Compare Result by given condition and Bit Result (BR), and then saves its result in BR	○	○
	OR3>				
	OR3<				
	OR3>=				
	OR3<=				
	OR3<>				
Three 16-Bit Data Compare (LOAD)	LOADD3=		Saves 1 in Bit Result(BR) if each value of (S1+1,S1), (S2+ 1,S2), (S3+1,S3) meets given condition	○	○
	LOADD3>				
	LOADD3<				
	LOADD3>=				
	LOADD3<=				
	LOADD3<>				

4) Comparison instruction (continued)

Classification	Designations	Symbol	Description	Support	
				XGK	XGB
Three 32-Bit Data Compare (AND)	ANDD3=		Performs AND operation of (S1+1,S1), (S2+1,S2), (S3+1,S3) Compare Result by given condition and Bit Result (BR), and then saves its result in BR	○	○
	ANDD3>				
	ANDD3<				
	ANDD3>=				
	ANDD3<=				
	ANDD<>				
Three 32-Bit Data Compare (OR)	ORD3=		Performs OR operation of (S1+1,S1), (S2+1,S2), (S3+1,S3) Compare Result by given condition and Bit Result (BR), and then saves its result in BR	○	○
	ORD3>				
	ORD3<				
	ORD3>=				
	ORD3<=				
	ORD3<>				

5) Increase/Decrease instruction

Classification	Designations	Symbol	Description	Support	
				XGK	XGB
BIN Data Increase / Decrease (Signed)	INC		$(D)+1 \longrightarrow (D)$	2	4-94
	INCP				
	DINC		$(D+1,D)+1 \longrightarrow (D+1,D)$	2	
	DINCP				
	DEC		$(D)-1 \longrightarrow (D)$	2	4-96
	DECP				
	DDEC		$(D+1,D)-1 \longrightarrow (D+1,D)$	2	
	DDECP				
4/8 Bits Data Increase / Decrease (Signed)	INC4		$(D:x \text{ bit} \sim D:x \text{ bit}+4) + 1$	2	4-95
	INC4P		$\longrightarrow (D:x \text{ bit} \sim D:x \text{ bit}+4)$	3	
	INC8		$(D:x \text{ bit} \sim D:x \text{ bit}+8) + 1$	2	
	INC8P		$\longrightarrow (D:x \text{ bit} \sim D:x \text{ bit}+8)$	3	
	DEC4		$(D:x \text{ bit} \sim D:x \text{ bit}+4) - 1$	2	4-97
	DEC4P		$\longrightarrow (D:x \text{ bit} \sim D:x \text{ bit}+4)$	3	
	DEC8		$(D:x \text{ bit} \sim D:x \text{ bit}+8) - 1$	2	
	DEC8P		$\longrightarrow (D:x \text{ bit} \sim D:x \text{ bit}+8)$	3	
BIN Data Increase / Decrease (Unsigned)	INCUP		$(D)+1 \longrightarrow (D)$	2	4-98
	INCUCP				
	DINCUP		$(D+1,D)+1 \longrightarrow (D+1,D)$	2	
	DINCUCP				
	DECUP		$(D)-1 \longrightarrow (D)$	2	4-99
	DECUCP				
	DDECUP		$(D+1,D)-1 \longrightarrow (D+1,D)$	2	
	DDECUCP				

6) Rotation instruction

Classification	Designations	Symbol	Description	Support	
				XGK	XGB
Rotate to Left	ROL			○	○
	ROLP				
	DROL				
	DROLP				
4/8 Bits Rotate to Left	ROL4			○	○
	ROL4P				
	ROL8				
	ROL8P				
Rotate to Right	ROR			○	○
	RORP				
	DROR				
	DRORP				
4/8 Bits Rotate to Right	ROR4			○	○
	ROR4P				
	ROR8				
	ROR8P				
Rotate to Left (including Carry)	RCL			○	○
	RCLP				
	DRCL				
	DRCLP				
4/8 Bits Rotate to Left (including Carry)	RCL4			○	○
	RCL4P				
	RCL8				
	RCL8P				
Rotate to Right (including Carry)	RCR			○	○
	RCRP				
	DRCR				
	DRCRP				
4/8 Bits Rotate to Right (including Carry)	RCR4			○	○
	RCR4P				
	RCR8				
	RCR8P				

7) Move instruction

Classification	Designations	Symbol	Description	Support	
				XGK	XGB
Bits Move	BSFT			○	○
	BSFTP			○	○
Move to Higher Bit	BSFL			○	○
	BSFLP			○	○
	DBSFL			○	○
	DBSFLP			○	○
Move to Higher Bit within 4/8 Bits range	BSFL4			○	○
	BSFL4P			○	○
	BSFL8			○	○
	BSFL8P			○	○
Move to Lower Bit	BSFR			○	○
	BSFRP			○	○
	DBSFR			○	○
	DBSFRP			○	○
Move to Lower Bit within 4/8 Bits range	BSFR4			○	○
	BSFR4P			○	○
	BSFR8			○	○
	BSFR8P			○	○
Word Move	WSFT			○	○
	WSFTP			○	○
Word Data Move to Left/Right	WSFL			○	○
	WSFLP			○	○
	WSFR			○	○
	WSFRP			○	○
Bit Move	SR		Moves N bits starting from Db bit along Input direction (I) and Move direction (D)	○	○

8) Exchange instruction

Classification	Designations	Symbol	Description	Support	
				XGK	XGB
Data Exchange	XCHG		(D1) ↔ (D2)	○	○
	XCHGP				
	DXCHG		(D1+1, D1) ↔ (D2+1, D2)		
	DXCHGP				
Group Data Exchange	GXCHG			○	○
	GXCHGP				
Higher/Lower Byte Exchange	SWAP			○	○
	SWAPP				
Group Byte Exchange	GSWAP		Exchanges Higher/Lower Byte of Words N starting from D	○	○
	GSWAPP				

9) BIN operation instruction

Classification	Designations	Symbol	Description	Support	
				XGK	XGB
Integer Addition (Signed)	ADD		$(S1)+(S2) \longrightarrow (D)$	○	○
	ADDP				
	DADD		$(S1+1,S1)+(S2+1,S2)$		
	DADDP		$\longrightarrow (D+1,D)$		
Integer Subtraction (Signed)	SUB		$(S1)-(S2) \longrightarrow (D)$	○	○
	SUBP				
	DSUB		$(S1+1,S1)-(S2+1,S2)$		
	DSUBP		$\longrightarrow (D+1,D)$		
Integer Multiplication (Signed)	MUL		$(S1)\times(S2) \longrightarrow (D+1,D)$	○	○
	MULP				
	DMUL		$(S1+1,S1)\times(S2+1,S2)$		
	DMULP		$\longrightarrow (D+3,D+2,D+1,D)$		
Integer Division (Signed)	DIV		$(S1)\div(S2) \longrightarrow \begin{matrix} (D) \text{ Quotient} \\ (D+1) \text{ Remainder} \end{matrix}$	○	○
	DIVP				
	DDIV		$(S1+1,S1)\div(S2+1,S2)$		
	DDIVP		$\longrightarrow \begin{matrix} (D+1,D) \text{ Quotient} \\ (D+3,D+2) \text{ Remainder} \end{matrix}$		
Integer Addition (Unsigned)	ADDU		$(S1)+(S2) \longrightarrow (D)$	○	○
	ADDUP				
	DADDU		$(S1+1,S1)+(S2+1,S2)$		
	DADDUP		$\longrightarrow (D+1,D)$		
Integer Subtraction (Unsigned)	SUBU		$(S1)-(S2) \longrightarrow (D)$	○	○
	SUBUP				
	DSUBU		$(S1+1,S1)-(S2+1,S2)$		
	DSUBUP		$\longrightarrow (D+1,D)$		
Integer Multiplication (Unsigned)	MULU		$(S1)\times(S2) \longrightarrow (D+1,D)$	○	○
	MULUP				
	DMULU		$(S1+1,S1)\times(S2+1,S2)$		
	DMULUP		$\longrightarrow (D+3,D+2,D+1,D)$		

9) BIN operation instruction (continued)

Classification	Designations	Symbol	Description	Support	
				XGK	XGB
Integer Division (Unsigned)	DIVU		$(S1) \div (S2) \longrightarrow$ (D) Quotient (D+1) Remainder	○	○
	DIVUP				
	DDIVU		$(S1+1, S1) \div (S2+1, S2)$		
	DDIVUP		\longrightarrow (D+1, D) Quotient (D+3, D+2) Remainder		
Real Number Addition	RADD		$(S1+1, S1) + (S2+1, S2)$ \longrightarrow (D+1, D)	○	○
	RADDP				
	LADD		$(S1+3, S1+2, S1+1, S1)$ $+ (S2+3, S2+2, S2+1, S2)$		
	LADDP		\longrightarrow (D+3, D+2, D+1, D)		
Real Number Subtraction	RSUB		$(S1+1, S1) - (S2+1, S2)$ \longrightarrow (D+1, D)	○	○
	RSUBP				
	LSUB		$(S1+3, S1+2, S1+1, S1)$ $- (S2+3, S2+2, S2+1, S2)$		
	LSUBP		\longrightarrow (D+3, D+2, D+1, D)		
Real Number Multiplication	RMUL		$(S1+1, S1) \times (S2+1, S2)$ \longrightarrow (D+1, D)	○	○
	RMULP				
	LMUL		$(S1+3, S1+2, S1+1, S1)$ $\times (S2+3, S2+2, S2+1, S2)$		
	LMULP		\longrightarrow (D+3, D+2, D+1, D)		
Real Number Division	RDIV		$(S1+1, S1) \div (S2+1, S2)$ \longrightarrow (D+1, D)	○	○
	RDIVP				
	LDIV		$(S1+3, S1+2, S1+1, S1)$ $\div (S2+3, S2+2, S2+1, S2)$		
	LDIVP		\longrightarrow (D+3, D+2, D+1, D)		
String Addition	\$ADD		Connects S1 String with S2 String to save in D	○	○
	\$ADDP				
Group Addition	GADD		$\begin{matrix} (S1) & + & (S2) & = & (D) \\ \begin{matrix} \text{---} \\ \text{---} \\ \text{---} \end{matrix} & & \begin{matrix} \text{---} \\ \text{---} \\ \text{---} \end{matrix} & & \begin{matrix} \text{---} \\ \text{---} \\ \text{---} \end{matrix} \end{matrix} \quad \begin{matrix} \updownarrow \\ N \end{matrix}$	○	○
	GADDP				
Group Subtraction	GSUB		$\begin{matrix} (S1) & - & (S2) & = & (D) \\ \begin{matrix} \text{---} \\ \text{---} \\ \text{---} \end{matrix} & & \begin{matrix} \text{---} \\ \text{---} \\ \text{---} \end{matrix} & & \begin{matrix} \text{---} \\ \text{---} \\ \text{---} \end{matrix} \end{matrix} \quad \begin{matrix} \updownarrow \\ N \end{matrix}$	○	○
	GSUBP				

10) BCD operation instruction

Classification	Designations	Symbol	Description	Support	
				XGK	XGB
BCD Addition	ADDB		$(S1)+(S2) \longrightarrow (D)$	○	○
	ADDBP				
	DADDB		$(S1+1,S1)+(S2+1,S2)$		
	DADDBP		$\longrightarrow (D+1,D)$		
BCD Subtraction	SUBB		$(S1)-(S2) \longrightarrow (D)$	○	○
	SUBBP				
	DSUBB		$(S1+1,S1)-(S2+1,S2)$		
	DSUBBP		$\longrightarrow (D+1,D)$		
BCD Multiplication	MULB		$(S1) \times (S2) \longrightarrow (D+1,D)$	○	○
	MULBP				
	DMULB		$(S1+1,S1) \times (S2+1,S2)$		
	DMULBP		$\longrightarrow (D+3,D+2,D+1,D)$		
BCD Division	DIVB		$(S1) \div (S2) \longrightarrow$ (D) Quotient (D+1) Remainder	○	○
	DIVBP				
	DDIVB		$(S1+1,S1) \div (S2+1,S2)$		
	DDIVBP		\longrightarrow (D+1,D) Quotient (D+3,D+2) Remainder		

11) Logic operation instruction

Classification	Designations	Symbol	Description	Basic Steps	Page
Logic Multiplication	WAND		Word AND $(S1) \wedge (S2) \longrightarrow (D)$	○	○
	WANDP				
	DWAND		DWord AND $(S1+1, S1) \wedge (S2+1, S2) \longrightarrow (D+1, D)$		
	DWANDP				
Logic Addition	WOR		Word OR $(S1) \vee (S2) \longrightarrow (D)$	○	○
	WORP				
	DWOR		DWord OR $(S1+1, S1) \vee (S2+1, S2) \longrightarrow (D+1, D)$		
	DWORP				
Exclusive OR	WXOR		Word Exclusive OR $(S1) \nabla (S2) \longrightarrow (D)$	○	○
	WXORP				
	DWXOR		DWord Exclusive OR $(S1+1, S1) \nabla (S2+1, S2) \longrightarrow (D+1, D)$		
	DWXORP				
Exclusive NOR	WXNR		Word Exclusive NOR $(S1) \nabla (S2) \longrightarrow (D)$	○	○
	WXNRP				
	DWXNR		DWord Exclusive NOR $(S1+1, S1) \nabla (S2+1, S2) \longrightarrow (D+1, D)$		
	DWXNRP				
Group Logic Operation	GWAND			○	○
	GWANDP				
	GWOR				
	GWORP				
	GWXOR				
	GWXORP				
	GWXNR				
	GWXNRP				

12) Data process instruction

Classification	Designations	Symbol	Description	Support	
				XGK	XGB
Bit Check	BSUM			○	○
	BSUMP				
	DBSUM				
	DBSUMP				
Bit Reset	BRST		Resets N Bits (starting from D) to 0	○	○
	BRSTP				
Encode	ENCO			○	○
	ENCOP				
Decode	DECO			○	○
	DECOP				
Data Disconnect & Connect	DIS			○	○
	DISP				
	UNI				
	UNIP				
Word/ Byte Conversion	WTOB			○	○
	WTOBP				
	BTOW				
	BTOWP				
I/O Refresh	IORF		Right after masking I/O data (located on S1) with S2 and S3 data, perform process	○	○
	IORFP				
Data Search	SCH		Finds S1 value within S2 ~ N range and saves the first identical valued position in D and S1's identical valued total number in D+1	○	○
	SCHP				
	DSCH				
	DSCHP				
Max. Value Search	MAX		Saves the max value in D among N words starting from S	○	○
	MAXP				
	DMAX		Saves the max value in D among N double words starting from S		
	DMAXP				

12) Data process instruction (continued)

Classification	Designations	Symbol	Description	Support	
				XGK	XGB
Min. Value Search	MIN		Saves the min value in D among N words starting from S	○	○
	MINP				
	DMIN		Saves the min value in D among N double words starting from S		
	DMINP				
Sum	SUM		Adds up N words starting from S to save in D	○	○
	SUMP				
	DSUM		Adds up N double words starting from S to save in D		
	DSUMP				
Average	AVE		Averages N words starting from S to save in D	○	○
	AVEP				
	DAVE		Averages N double words starting from S to save in D		
	DAVEP				
MUX	MUX			○	○
	MUXP				
	DMUX				
	DMUXP				
Data Detect	DETECT		Detects N data from S1, to save the first value larger than S2 in D, and the extra number in D+1	○	○
	DETECTP				
Ramp Signal Output	RAMP		Saves linear-changed value in D1 during n3 scanning of initial value n1 to final n2 and present scanning number in D1+1, and changes D2 value to ON after completed	○	○
Data Align	SORT		S : Head Address of Sort Data n1 : Number of Words to sort n1+1 : Sorting Method n2: Operation number per Scan D1 : ON if complete D2 : Auxiliary Area	○	○
	SORTP				

13) Data table process instruction

Classification	Designations	Symbol	Description	Support	
				XGK	XGB
Data Write	FIWR	$\boxed{\text{FIWR}} \quad \boxed{\text{S}} \quad \boxed{\text{D}}$	Adds S to the last of Data Table D ~ D+N, and increases Data Table Length(N) saved in D by 1	○	○
	FIWRP	$\boxed{\text{FIWRP}} \quad \boxed{\text{S}} \quad \boxed{\text{D}}$			
First-input Data Read	FIFRD	$\boxed{\text{FIFRD}} \quad \boxed{\text{S}} \quad \boxed{\text{D}}$	Moves first data, S+1 of Data Table S ~ S+N to D (pull 1 place after origin deleted) and decreases Data Table Length(N) saved in D by 1 S	○	○
	FIFRDP	$\boxed{\text{FIFRDP}} \quad \boxed{\text{S}} \quad \boxed{\text{D}}$			
Last-Input Data Read	FILRD	$\boxed{\text{FILRD}} \quad \boxed{\text{S}} \quad \boxed{\text{D}}$	Moves last data, S+N of Data Table S ~ S+N to D (origin deleted) and decreases Data Table Length(N) saved in D by 1 S	○	○
	FILRDP	$\boxed{\text{FILRDP}} \quad \boxed{\text{S}} \quad \boxed{\text{D}}$			
Data Insert	FIINS	$\boxed{\text{FINS}} \quad \boxed{\text{S}} \quad \boxed{\text{D}} \quad \boxed{\text{n}}$	Adds S to 'N'th place of Data Table D ~ D+N (origin data pulled by 1), and increases Data Table Length(N) saved in D by 1	○	○
	FIINSP	$\boxed{\text{FINSP}} \quad \boxed{\text{S}} \quad \boxed{\text{D}} \quad \boxed{\text{n}}$			
Data Pull	FIDEL	$\boxed{\text{FDEL}} \quad \boxed{\text{S}} \quad \boxed{\text{D}} \quad \boxed{\text{n}}$	Deletes 'N'th data of Data Table S ~ S+N (pull 1 place) and decreases Data Table Length(N) saved in D by 1	○	○
	FIDELP	$\boxed{\text{FDELP}} \quad \boxed{\text{S}} \quad \boxed{\text{D}} \quad \boxed{\text{n}}$			

14) Display instruction

Classification	Designations	Symbol	Description	Support	
				XGK	XGB
7 Segment Display	SEG	$\boxed{\text{SEG}} \quad \boxed{\text{S}} \quad \boxed{\text{D}} \quad \boxed{\text{Z}}$	Converts S Data to 7-Segment as adjusted in Z Format so to save in D	○	○
	SEGP	$\boxed{\text{SEGP}} \quad \boxed{\text{S}} \quad \boxed{\text{D}} \quad \boxed{\text{Z}}$			

Appendix 4 Instruction List

15) String Process instruction

Classification	Designations	Symbol	Description	Support	
				XGK	XGB
Convert to Decimal ASCII Cord	BINDA	$\boxed{\text{BINDA}} \text{ S D}$	Converts S of 1-word BIN value to Decimal ASCII Cord to save in starting D	○	○
	BINDAP	$\boxed{\text{BINDAP}} \text{ S D}$			
	DBINDA	$\boxed{\text{DBINDA}} \text{ S D}$	Converts S of 2-word BIN value to Decimal ASCII Cord to save in starting D		
	DBINDAP	$\boxed{\text{DBINDAP}} \text{ S D}$			
Convert to Hexadecimal ASCII Cord	BINHA	$\boxed{\text{BINHA}} \text{ S D}$	Converts S of 1-word BIN value to Hexadecimal ASCII Cord to save in starting D	○	○
	BINHAP	$\boxed{\text{BINHAP}} \text{ S D}$			
	DBINHA	$\boxed{\text{DBINHA}} \text{ S D}$	Converts S of 2-word BIN value to Hexadecimal ASCII Cord to save in starting D		
	DBINHAP	$\boxed{\text{DBINHAP}} \text{ S D}$			
Convert BCD to Decimal ASCII Cord	BCDDA	$\boxed{\text{BCDDA}} \text{ S D}$	Converts S of 1-word BCD to ASCII Cord to save in starting D	○	○
	BCDDAP	$\boxed{\text{BCDDAP}} \text{ S D}$			
	DBCDDA	$\boxed{\text{DBCDDA}} \text{ S D}$	Converts S of 2-word BCD to ASCII Cord to save in starting D		
	DBCDDAP	$\boxed{\text{DBCDDAP}} \text{ S D}$			
Convert Decimal ASCII to BIN	DABIN	$\boxed{\text{DABIN}} \text{ S D}$	Converts S S+2,S+1,S's Decimal ASCII Cord to BIN to save in D	○	○
	DABINP	$\boxed{\text{DABINP}} \text{ S D}$			
	DDABIN	$\boxed{\text{DDABIN}} \text{ S D}$	Converts S+5~S's Decimal ASCII Cord to BIN value to save in D+1 & D		
	DDABINP	$\boxed{\text{DDABINP}} \text{ S D}$			
Convert Hexadecimal ASCII to BIN	HABIN	$\boxed{\text{HABIN}} \text{ S D}$	Converts S+1,S's Hexadecimal ASCII Cord to BIN value to save in D	○	○
	HABINP	$\boxed{\text{HABINP}} \text{ S D}$			
	DHABIN	$\boxed{\text{DHABIN}} \text{ S D}$	Converts S+3~S's Hexadecimal ASCII Cord to BIN to save in D		
	DHABINP	$\boxed{\text{DHABINP}} \text{ S D}$			
Convert Decimal ASCII to BCD	DABCD	$\boxed{\text{DABCD}} \text{ S D}$	Converts S+1,S's Decimal ASCII Cord to BCD to save in D	○	○
	DABCDP	$\boxed{\text{DABCDP}} \text{ S D}$			
	DDABCD	$\boxed{\text{DDABCD}} \text{ S D}$	Converts S+3~S's Decimal ASCII Cord to BCD to save in D		
	DDABCDP	$\boxed{\text{DDABCDP}} \text{ S D}$			
String Length Detect	LEN	$\boxed{\text{LEN}} \text{ S D}$	Saves String Length with S starting in D	○	○
	LENP	$\boxed{\text{LENP}} \text{ S D}$			

15) String process instruction (continued)

Classification	Designations	Symbol	Description	Support	
				XGK	XGB
Convert BIN16/32 to String	STR	—STR S1 S2 D—	Adjusts S2 saved word data to S1 saved place number to convert to String and save in D	○	○
	STRP	—STRP S1 S2 D—			
	DSTR	—DSTR S1 S2 D—	Adjusts S2 saved double word data to S1 saved place number to convert to String and save in D		
	DSTRP	—DSTRP S1 S2 D—			
Convert String to BIN16/32	VAL	—VAL S D1 D2—	Adjusts S saved string to number to save in word D1 and saves the place number in D2	○	○
	VALP	—VALP S D1 D2—			
	DVAL	—DVAL S D1 D2—	Adjusts S saved string to number to save in double word D1 and saves the place number in D2		
	DVALP	—DVALP S D1 D2—			
Convert Real Number to String	RSTR	—RSTR S1 S2 D—	Adjusts Floating decimal point point Real Number Data (S1: number, S2: places) to String format to save in D	○	X
	RSTRP	—RSTRP S1 S2 D—			
	LSTR	—LSTR S1 S2 D—	Adjusts Floating decimal point point Double Real Number Data (S1:number, S2:places) to String format to save in D		
	LSTRP	—LSTRP S1 S2 D—			
Convert String to Real Number	STRR	—STRR S D—	Converts String S to Floating decimal point point Real Number Data to save in D	○	X
	STRRP	—STRRP S D—			
	STRL	—STRL S D—	Converts String S to Floating decimal point point Double Real Number Data to save in D		
	STRLP	—STRLP S D—			
ASCII Conversion	ASC	—ASC S D cw—	Converts BIN Data to ASCII in Nibble unit, based on cw's format from S to save in D	○	○
	ASCP	—ASCP S D cw—			
HEX Conversion	HEX	—HEX S D N—	Converts 2N ASCII saved in N words from S in byte unit to Nibble unit of Hexadecimal BIN so to save in D	○	○
	HEXP	—HEXP S D N—			
String Extract from Right	RIGHT	—RIGHT S D N—	Extracts n string from S string's final letter to save in starting D	○	○
	RIGHTP	—RIGHTP S D N—			
String Extract from Left	LEFT	—LEFT S D N—	Extracts n string from S string's first letter to save in starting D	○	○
	LEFTP	—LEFTP S D N—			
String Random Extract	MID	—MID S1 S2 D—	Extracts string which conforms to S2 condition among S1 string to save in starting D	○	○
	MIDP	—MIDP S1 S2 D—			

15) String process instruction (continued)

Classification	Designations	Symbol	Description	Basic Steps	Page
String Random Replace	REPLACE	— REPLACE S1 D S2 —	Processes S1 String as applicable to S2 Condition to save in D String	○	○
	REPLACEP	— REPLACEP S1 D S2 —			
String Find	FIND	— FIND S1 S2 D N —	Finds identical String to S2 in S1 ~ N data to save the absolute position in D	○	○
	FINDP	— FINDP S1 S2 D N —			
Parse Real Number to BCD	RBCD	— RBCD S1 S2 D —	Adjusts Floating decimal point point Real Number Data S1 to S2 place to convert to BCD, and then to save in D	○	X
	RBCDP	— RBCDP S1 S2 D —			
	LBCD	— LBCD S1 S2 D —	Adjusts Floating decimal point point Double Real Number Data S1 to S2 place to convert to BCD, and then to save in D		
	LBCDP	— LBCDP S1 S2 D —			
Convert BCD Data to Real Number	BCDR	— BCDR S1 S2 D —	Adjusts BCD Data S1 to S2 place to convert to Floating decimal point point Real Number, and then to save in D	○	X
	BCDRP	— BCDRP S1 S2 D —			
	BCDL	— BCDL S1 S2 D —	Adjusts BCD Data S1 to S2 place to convert to Floating decimal point point Double Real Number, and then to save in D		
	BCDLP	— BCDLP S1 S2 D —			

16) Special function instruction







Classification	Designations	Symbol	Description	Basic Steps	Page
SIN Operation	SIN		$SIN(S+1,S) \longrightarrow (D+1,D)$	○	○
	SINP				
COS Operation	COS		$COS(S+1,S) \longrightarrow (D+1,D)$	○	○
	COSP				
TAN Operation	TAN		$TAN(S+1,S) \longrightarrow (D+1,D)$	○	○
	TANP				
RAD Conversion	RAD		$(S+1,S) \longrightarrow (D+1,D)$ Converts angle to radian	○	○
	RADP				
Angle Conversion	DEG		$(S+1,S) \longrightarrow (D+1,D)$ Converts radian to angle	○	○
	DEGP				
Square Root Operation	SQRT		$\sqrt{(S+1,S)} \longrightarrow (D+1,D)$	○	○
	SQRTP				

Appendix 4 Instruction List

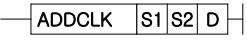
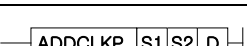
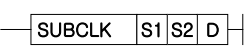
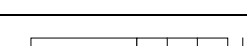
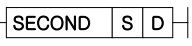
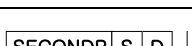

17) Data control instruction

Classification	Designations	Symbol	Description	Basic Steps	Page
Limit Control	LIMIT	$\boxed{\text{LIMIT}} \quad \boxed{S1} \boxed{S2} \boxed{S3} \boxed{D}$	If $S1 < S2$, then $D = S2$ If $S2 < S1 < S3$, then $D = S1$ If $S3 < S1$, then $D = S3$	○	○
	LIMITP	$\boxed{\text{LIMITP}} \quad \boxed{S1} \boxed{S2} \boxed{S3} \boxed{D}$			
	DLIMIT	$\boxed{\text{DLIMIT}} \quad \boxed{S1} \boxed{S2} \boxed{S3} \boxed{D}$			
	DLIMITP	$\boxed{\text{DLIMITP}} \quad \boxed{S1} \boxed{S2} \boxed{S3} \boxed{D}$			
Dead-zone Control	DZONE	$\boxed{\text{DZONE}} \quad \boxed{S1} \boxed{S2} \boxed{S3} \boxed{D}$	If $S1 < -S2$, then $D = S1+S2-S2(S3/100)$ If $-S2 < S1 < S2$, then $D = (S3/100)S1$ If $S1 < S2$, then $D = S1-S2+S2(S3/100)$	○	○
	DZONEP	$\boxed{\text{DZONEP}} \quad \boxed{S1} \boxed{S2} \boxed{S3} \boxed{D}$			
	DDZONE	$\boxed{\text{DDZONE}} \quad \boxed{S1} \boxed{S2} \boxed{S3} \boxed{D}$			
	DDZONEP	$\boxed{\text{DDZONEP}} \quad \boxed{S1} \boxed{S2} \boxed{S3} \boxed{D}$			
Vertical-zone Control	VZONE	$\boxed{\text{VZONE}} \quad \boxed{S1} \boxed{S2} \boxed{S3} \boxed{D}$	If $S1 < -S2(S3/100)$, then $D = S1-S2+S2(S3/100)$ If $-S2(S3/100) < S1 < S2(S3/100)$, then $D = (100/S3)S1$ If $S1 < S2(S3/100)$, then $D = S1+S2-S2(S3/100)$	○	○
	VZONEP	$\boxed{\text{VZONEP}} \quad \boxed{S1} \boxed{S2} \boxed{S3} \boxed{D}$			
	DVZONE	$\boxed{\text{DVZONE}} \quad \boxed{S1} \boxed{S2} \boxed{S3} \boxed{D}$			
	DVZONEP	$\boxed{\text{DVZONEP}} \quad \boxed{S1} \boxed{S2} \boxed{S3} \boxed{D}$			
Built-in PID Control Instruction	PIDRUN	$\boxed{\text{PIDRUN}} \quad \boxed{N}$	Operates PID Loop N	○	○
	PIDPAUSE	$\boxed{\text{PIDPAUSE}} \quad \boxed{N}$	Stops PID Loop N momentarily	○	X
	PIDPRMT	$\boxed{\text{PIDPRMT}} \quad \boxed{S} \quad \boxed{N}$	Changes PID Loop N's Parameter. (SV(word) / Ts(word) / Kp(real) / Ti(real) / Td(real))	○	X
	PIDAT	$\boxed{\text{PIDRUN}} \quad \boxed{N}$	Start of PID loop Auto-tuning	X	○
	PIDCAS	$\boxed{\text{PIDPRMT}} \quad \boxed{S} \quad \boxed{N}$	Start of PID loop cascade operation	X	○
	PIDHBD	$\boxed{\text{PIDPRMT}} \quad \boxed{S} \quad \boxed{N}$	Start of PID loop combination operation	X	○

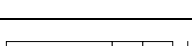
18) Time related instruction

Classification	Designations	Symbol	Description	Support	
				XGK	XGB
Date/Time Data Read	DATERD		Reads PLC Time to save in D ~ D+6 (Yr/Mn/Dt/Hr/Mn/Sd/Day)	○	X
	DATERDP				
Date/Time Data Write	DATEWR		Input S ~ S+6's Time Data in PLC (Yr/Mn/Dt/Hr/Mn/Sd/Day)	○	X
	DATEWRP				
Time Data Increase	ADDCLK		Adds S1 ~ S1+2 & S2 ~ S2+2 Time Data to save in D ~ D+2 in Time Data format (Hr/Mn/Sd)	○	X
	ADDCLKP				
Time Data Decrease	SUBCLK		Extracts S2 ~ S2+2's Time Data from S1 ~ S1+2 to save in D ~ D+2 in Time Data format (Hr/Mn/Sd)	○	X
	SUBCLKP				
Time Data Format Conversion	SECOND		Converts Time Data S ~ S+2 to seconds to save in double word D	○	X
	SECONDP				
	HOUR		Converts the seconds saved in double word S to Hr/Mn/Sd to save in D ~ D+2	○	X
	HOURP				

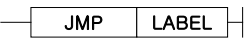
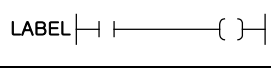
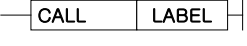
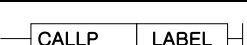
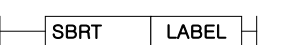
19) Divergence instruction

Classification	Designations	Symbol	Description	Support	
				XGK	XGB
Divergence Instruction	JMP		Jumps to LABEL location	○	○
	LABEL		Jumps and designates the location to move to		
Subroutine Call Functional	CALL		Calls Function applicable to LABEL	○	○
	CALLP				
	SBRT		Designates Function to be called by CALL		
	RET		RETURN		

20) Loop instruction

Classification	Designations	Symbol	Description	Support	
				XGK	XGB
Loop Instruction	FOR		Operates FOR~NEXT section n times	○	○
	NEXT				
	BREAK		Escapes from FOR~NEXT section	○	○

21) Flag instruction

Classification	Designations	Symbol	Description	Support	
				XGK	XGB
Carry Flag Set, Reset	STC		Carry Flag (F0112) SET	○	○
	CLC		Carry Flag (F0112) RESET		
Error Flag Clear	CLE		Error Latch Flag (F0115) RESET	○	○

22) System instruction

Classification	Designations	Symbol	Description	Support	
				XGK	XGB
Error Display	FALS		Self Diagnosis (Error Display)	○	○
Scan Cluck	DUTY		On during n1 Scan, Off during n2 Scan	○	○
Time Cluck	TFLK		On during S1 set time, Off during S2 set time	○	○
WDT Initialize	WDT		Watch Dog Timer Clear	○	○
	WDTP				
Output Control	OUTOFF		All Output Off	○	○
Operation Stop	STOP		Finishes applicable scan to end PLC Operation	○	○
Emergent Operation Stop	ESTOP		Ends PLC operation right after Instruction executed	○	○

23) Interrupt related instruction

Classification	Designations	Symbol	Description	Support	
				XGK	XGB
All Channels Interrupt Setting	EI		All Channels Interrupt allowed	○	○
	DI		All Channel Interrupt prohibited		
Individual Channel Interrupt Setting	EIN		Individual Channel Interrupt allowed	○	○
	DIN		Individual Channel Interrupt prohibited		

24) Sign reversion instruction

Classification	Designations	Symbol	Description	Support	
				XGK	XGB
2's complement	NEG		Saves D value again in D with 2's complement taken	o	o
	NEGP				
	DNEG		Saves (D+1,D) value again in (D+1,D) with 2's complement taken		
	DNEGP				
Real Number Data Sign Reverse	RNEG		Reverses D Real Number Sign then to save again	o	o
	RNEGP				
	LNEGR		Reverses D Double Real Number Sign then to save again		
	LNEGP				
Absolute Value Operation	ABS		Converts D highest Bit to 0	o	o
	ABSP				
	DABS		Converts (D+1,D) highest Bit to 0		
	DABSP				

25) File related instruction

Classification	Designations	Symbol	Description	Support	
				XGK	XGB
Block Conversion	RSET		Changes Block Number of file register to S Number	o	X
	RSETP				
Flash Word Data Transfer	EMOV		Transfers S2 word data in S1 Block to D	o	X
	EMOVP				
Flash Double Word Data Transfer	EDMOV		Transfers S2+1, S2 double word data in S1 Block to D+1, D		
	EDMOVP				
Block Read	EBREAD		Reads Flash Memory Block	o	X
Block Write	EBWRITE		Writes Flash Memory Block	o	X
Block Compare	EBCMP		Compares R Area's Bank with Flash Area's Block	o	X

Appendix 4.4 Special/Communication Instruction



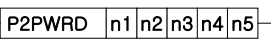
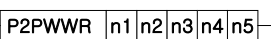
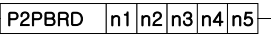
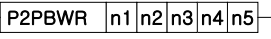

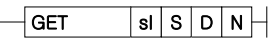
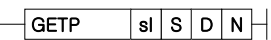
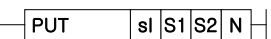
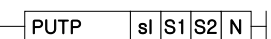

1) Communication module related instruction

Classification	Designations	Symbol	Description	Support	
				XGK	XGB
Station No. Set	P2PSN		Sets opposite station No. for P2P Communication. n1:P2P No., n2:Block, n3:Station No.	○	X
Read Area Set (WORD)	P2PWRD		Sets word data Read Area n1:P2P No., n2:Block, n3:Variable sequence, n4:Variable Size, n5:Device	○	X
Write Area Set (WORD)	P2PWWR		Sets word data Write Area n1:P2P No., n2:Block, n3:Variable sequence, n4:Variable Size, n5:Device	○	X
Read Area Set (BIT)	P2PBRD		Sets bit data Read Area n1:P2P No., n2:Block, n3:Variable sequence, n4: Variable Size, n5:Device	○	X
Write Area Set (BIT)	P2PBWR		Sets bit data Write Area n1:P2P No., n2:Block, n3:Variable sequence, n4:Variable Size, n5:Device	○	X

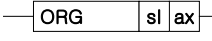
2) Special module common instruction

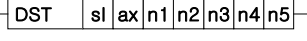
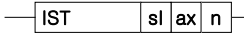
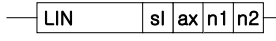
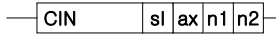
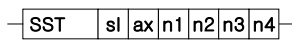
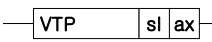
Classification	Designations	Symbol	Description	Support	
				XGK	XGB
Special Module Read/Write	GET		Reads data of special module memory is installed on	○	○
	GETP				
	PUT		Writes data on special module memory is installed on	○	○
	PUTP				

3) Exclusive positioning instruction

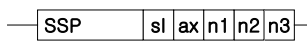
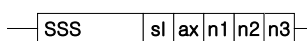
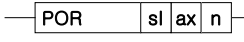
Classification	Designations	Symbol	Description	Support	
				XGK	XGB
Return to Origin Point	ORG		Instructions Positioning Module's ax axis installed on sl slot to return to Origin Point	○	○
Floating Origin Point	FLT		Instructions Positioning Module's ax axis installed on sl slot to set Floating Origin Point	○	○
Direct Start	DST		Instructions Positioning Module's ax axis installed on sl slot to start directly with Target Position(n1), Target Speed(n2), Dwell Time(n3), M Code(n4) & Control Word(n5)	○	○
Indirect Start	IST		Instructions Positioning Module's ax axis installed on sl slot to start n step indirectly	○	○
Linear Interpolation	LIN		Instructions Positioning Module's ax axis installed on sl slot to let n2 axes operate n1 step by Linear Interpolation	○	○
Circular Interpolation	CIN		Instructions Positioning Module's ax axis installed on sl slot to let n2 axes operate n1 step by Circular Interpolation	○	X
Simultaneous Start	SST		Instructions Positioning Module's ax axis installed on sl slot to let n4 axes operate n1(X), n2(Y), n3(Z) steps by Simultaneous Start	○	○
Speed/Position Control Switch	VTP		Instructions Positioning Module's ax axis installed on sl slot to switch Speed to Position Control	○	○
Position/Speed Control Switch	PTV		Instructions Positioning Module's ax axis installed on sl slot to switch Position to Speed Control	○	○
Decelerated Stop	STP		Instructions Positioning Module's ax axis installed on sl slot to stop as decelerated.	○	○
Skip	SKP		Instructions Positioning Module's ax axis installed on sl slot to skip	○	X
Position Synchronization	SSP		Instructions Positioning Module's ax axis installed on sl slot to do Position Sync with main axis of n3, n1 sync-positioned and n2 step operated	○	○
Speed Synchronization	SSS		Instructions Positioning Module's ax axis installed on sl slot to do Speed Sync with main axis of n3, n1 master and n2 slave	○	○
Position Override	POR		Instructions Positioning Module's ax axis installed on sl slot to override Position to change the target position to n	○	○

4) Exclusive position control instruction (continued)

Classification	Designations	Symbol	Description	Support	
				XGK	XGB
Speed Override	SOR		Instructions Positioning Module's ax axis installed on sl slot to override Speed to change the target speed to n	○	○
Position specified Speed Override	PSO		Instructions Positioning Module's ax axis installed on sl slot to override position specified speed to change the target speed to n2 from n1 position	○	○
Continuous Operation	NMV		Instructions Positioning Module's ax axis installed on sl slot to operate continuously to n step	○	X
Inching	INCH		Instructions Positioning Module's ax axis installed on sl slot to inch to n position	○	○
Return to Position Previous to Manual Operation	RTP		Instructions Positioning Module's ax axis installed on sl slot to return to position previous to manual operation	○	X
Operation Step Change	SNS		Instructions Positioning Module's ax axis installed on sl slot to change operation step to n	○	○
Repeated Operation Step Change	SRS		Instructions Positioning Module's ax axis installed on sl slot to change repeated operation step to n	○	X
M Code Off	MOF		Instructions Positioning Module's ax axis installed on sl slot to make M code off	○	○
Present Position Change	PRS		Instructions Positioning Module's ax axis to change present position to n	○	○
Zone Allowed	ZOE		Allows zone output of Positioning Module installed on sl slot	○	X
Zone Prohibited	ZOD		Prohibits zone output of Positioning Module installed on sl slot	○	X
Encoder Value change	EPRS		Changes Encoder Value of Positioning Module installed on sl slot to n	○	X
Teaching	TEA		Changes n1 step's target position or speed of Positioning Module's ax axis installed on sl slot	○	X
Teaching Array	TEAA		Changes multiple target positions or speed of Positioning Module's ax axis installed on sl slot	○	X
Emergent Stop	EMG		Instructions Positioning Module installed on sl slot to perform Emergent Stop	○	○

5) Exclusive position control instruction (continued)

Classification	Designations	Symbol	Description	Support	
				XGK	XGB
Error Reset	CLR	— CLR sl ax n	Resets Error originated from Positioning Module's ax axis installed on sl slot	○	○
Error History Reset	ECLR	— ECLR sl ax	Deletes Error History originated from Positioning Module's ax axis installed on sl slot	○	X
Point Operation	PST	— PST sl ax n	Performs Point Operation of Positioning Module's ax axis installed on sl slot	○	X
Basic Parameter Teaching	TBP	— TBP sl ax n1 n2	Changes n2 to n1 among basic parameters of Positioning Module's ax axis installed on sl slot	○	X
Extended Parameter Teaching	TEP	— TEP sl ax n1 n2	Changes n2 to n1 among extended parameters of Positioning Module's ax axis installed on sl slot	○	X
Return to Origin Point Parameter Teaching	THP	— THP sl ax n1 n2	Changes n2 to n1 among returned parameters to origin point of Positioning Module's ax axis installed on sl slot	○	X
Manual Operation Parameter Teaching	TMP	— TMP sl ax n1 n2	Changes n2 to n1 among manual operation parameters of Positioning Module's ax axis installed on sl slot	○	X
Input Signal Parameter Teaching	TSP	— TSP sl ax n	Changes input signal parameter of Positioning Module's ax axis installed on sl slot to the value set in n1	○	X
Common Parameter Teaching	TCP	— TCP sl ax n1 n2	Changes n2 to n1 among common parameters of Positioning Module installed on sl slot	○	X
Parameter Save	WRT	— WRT sl ax n	Instructions Positioning Module's ax axis installed on sl slot to save present parameter of n axis in flash ROM.	○	○
Present State Read	SRD	— SRD sl ax D	Reads and saves present state of Positioning Module's ax axis installed on sl slot in D area of CPU	○	X
Point Operation Step Write	PWR	— PWR sl ax S n1	Writes value of S area of CPU on point operation step area of Positioning Module's ax axis installed on sl slot in	○	X
Plural Teaching Data Write	TWR	— TWR sl ax S n1	Writes n value of S area of CPU on plural teaching dada area of Positioning Module's ax axis installed on sl slot in	○	X

Warranty

1. Warranty Period

The product you purchased will be guaranteed for 18 months from the date of manufacturing.

2. Scope of Warranty

Any trouble or defect occurring for the above-mentioned period will be partially replaced or repaired. However, please note the following cases will be excluded from the scope of warranty.

- (1) Any trouble attributable to unreasonable condition, environment or handling otherwise specified in the manual,
- (2) Any trouble attributable to others' products,
- (3) If the product is modified or repaired in any other place not designated by the company,
- (4) Due to unintended purposes
- (5) Owing to the reasons unexpected at the level of the contemporary science and technology when delivered.
- (6) Not attributable to the company; for instance, natural disasters or fire

3. Since the above warranty is limited to PLC unit only, make sure to use the product considering the safety for system configuration or applications.

Environmental Policy

LS ELECTRIC Co., Ltd supports and observes the environmental policy as below.

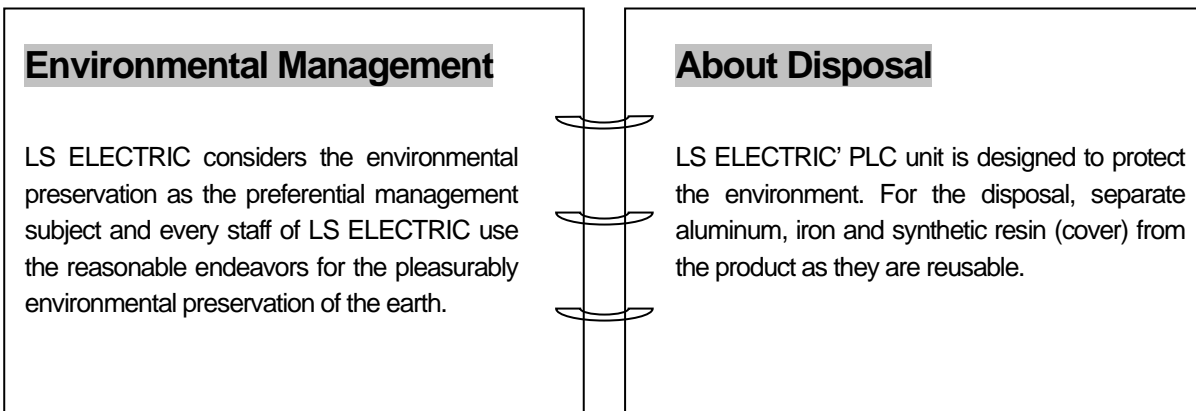



www.ls-electric.com

LS ELECTRIC Co., Ltd.

■ Headquarter

LS-ro 127(Hogye-dong) Dongan-gu, Anyang-si, Gyeonggi-Do, 14119, Korea

■ Seoul Office

LS Yongsan Tower, 92, Hangang-daero, Yongsan-gu, Seoul, 04386, Korea

Tel: 82-2-2034-4033, 4888, 4703 Fax: 82-2-2034-4588

E-mail: automation@ls-electric.com

■ Overseas Subsidiaries

• LS ELECTRIC Japan Co., Ltd. (Tokyo, Japan)

Tel: 81-3-6268-8241 E-Mail: japan@ls-electric.com

• LS ELECTRIC (Dalian) Co., Ltd. (Dalian, China)

Tel: 86-411-8730-6495 E-Mail: china.dalian@lselectric.com.cn

• LS ELECTRIC (Wuxi) Co., Ltd. (Wuxi, China)

Tel: 86-510-6851-6666 E-Mail: china.wuxi@lselectric.com.cn

• LS ELECTRIC Middle East FZE (Dubai, U.A.E.)

Tel: 971-4-886-5360 E-Mail: middleeast@ls-electric.com

• LS ELECTRIC Europe B.V. (Hoofddorp, Netherlands)

Tel: 31-20-654-1424 E-Mail: europartner@ls-electric.com

• LS ELECTRIC America Inc. (Chicago, USA)

Tel: 1-800-891-2941 E-Mail: sales.us@lselectricamerica.com

• LS ELECTRIC Turkey Co., Ltd.

Tel: 90-212-806-1225 E-Mail: turkey@ls-electric.com

■ Overseas Branches

• LS ELECTRIC Tokyo Office (Japan)

Tel: 81-3-6268-8241 E-Mail: tokyo@ls-electric.com

• LS ELECTRIC Beijing Office (China)

Tel: 86-10-5095-1631 E-Mail: china.auto@lselectric.com.cn

• LS ELECTRIC Shanghai Office (China)

Tel: 86-21-5237-9977 E-Mail: china.auto@lselectric.com.cn

• LS ELECTRIC Guangzhou Office (China)

Tel: 86-20-3818-2883 E-Mail: china.auto@lselectric.com.cn

• LS ELECTRIC Chengdu Office (China)

Tel: 86-28-8670-3201 E-Mail: china.auto@lselectric.com.cn

• LS ELECTRIC Qingdao Office (China)

Tel: 86-532-8501-2065 E-Mail: china.auto@lselectric.com.cn

• LS ELECTRIC Nanjing Office (China)

Tel: 86-25-8467-0005 E-Mail: china.auto@lselectric.com.cn

• LS ELECTRIC Bangkok Office (Thailand)

Tel: 66-90-950-9683 E-Mail: thailand@ls-electric.com

• LS ELECTRIC Jakarta Office (Indonesia)

Tel: 62-21-2933-7614 E-Mail: indonesia@ls-electric.com

• LS ELECTRIC Moscow Office (Russia)

Tel: 7-499-682-6130 E-Mail: info@lselectric-ru.com

• LS ELECTRIC America Western Office (Irvine, USA)

Tel: 1-949-333-3140 E-Mail: america@ls-electric.com

Disclaimer of Liability

LS ELECTRIC has reviewed the information in this publication to ensure consistency with the hardware and software described. However, LS ELECTRIC cannot guarantee full consistency, nor be responsible for any damages or compensation, since variance cannot be precluded entirely. Please check again the version of this publication before you use the product.

© LS ELECTRIC Co., Ltd 2015 All Right Reserved.

2023.02