

The right choice for the ultimate yield!

LS ELECTRIC strives to maximize your profits in gratitude for choosing us as your partner.

Programmable Logic Control

# Isolated Thermocouple Input Module

XGT Series

User Manual

XGF-TC4S



## Safety Instructions

- Read this manual carefully before installing, wiring, operating, servicing or inspecting this equipment.
- Keep this manual within easy reach for quick reference.

**LS**ELECTRIC

## Before using the product ...

For your safety and effective operation, please read the safety instructions thoroughly before using the product.

- ▶ Safety Instructions should always be observed in order to prevent accident or risk with the safe and proper use the product.
- ▶ Instructions are divided into “Warning” and “Caution”, and the meaning of the terms is as follows.



This symbol indicates the user is expected risk of death or serious injury in case of incorrect handling



This symbol indicates the user is expected risk of injury or property damage only in case of incorrect handling

Moreover, even classified events under its caution category may develop into serious accidents relying on situations. Therefore we strongly advise users to observe all precautions properly just like warnings.

- ▶ The marks displayed on the product and in the user’s manual have the following meanings.

 Be careful! Danger may be expected.

 Be careful! Electric shock may occur.

- ▶ The user’s manual even after read shall be kept available and accessible to any user of the product.

## Safety Instructions for design process

### Warning

- ▶ **Please install a protection circuit on the exterior of PLC so that the whole system may operate safely regardless of failures from external power or PLC.** Any abnormal output or operation from PLC may cause serious problems to safety in whole system.
  - Install protection units on the exterior of PLC like an interlock circuit that deals with opposite operations such as emergency stop, protection circuit, and forward/reverse rotation or install an interlock circuit that deals with high/low limit under its position controls.
  - If any system error (watch-dog timer error, module installation error, etc.) is detected during CPU operation in PLC, all output signals are designed to be turned off and stopped for safety. However, there are cases when output signals remain active due to device failures in Relay and TR which can't be detected. Thus, you are recommended to install an addition circuit to monitor the output status for those critical outputs which may cause significant problems.
  
- ▶ **Never overload more than rated current of output module nor allow to have a short circuit.** Over current for a long period time may cause a fire.
  
- ▶ **Never let the external power of the output circuit to be on earlier than PLC power,** which may cause accidents from abnormal output or operation.
  
- ▶ **Please install interlock circuits in the sequence program for safe operations in the system when exchange data with PLC or modify operation modes using a computer or other external equipments** Read specific instructions thoroughly when conducting control operations with PLC.

## Safety Instructions for design process

### **Caution**

- ▶ **I/O signal or communication line shall be wired at least 100mm away from a high-voltage cable or power line.** Fail to follow this instruction may cause malfunctions from noise

## Safety Instructions on installation process

### **Caution**

- ▶ **Use PLC only in the environment specified in PLC manual or general standard of data sheet.** If not, electric shock, fire, abnormal operation of the product may be caused.
- ▶ **Before install or remove the module, be sure PLC power is off.** If not, electric shock or damage on the product may be caused.
- ▶ **Be sure that every module is securely attached after adding a module or an extension connector.** If the product is installed loosely or incorrectly, abnormal operation, error or dropping may be caused. In addition, contact failures under poor cable installation will be causing malfunctions as well.
- ▶ **Be sure that screws get tighten securely under vibrating environments.** Fail to do so will put the product under direct vibrations which will cause electric shock, fire and abnormal operation.
- ▶ **Do not come in contact with conducting parts in each module,** which may cause electric shock, malfunctions or abnormal operation.

## Safety Instructions for wiring process

### **Warning**

- ▶ **Prior to wiring works, make sure that every power is turned off.** If not, electric shock or damage on the product may be caused.
- ▶ **After wiring process is done, make sure that terminal covers are installed properly before its use.** Fail to install the cover may cause electric shocks.

### **Caution**

- ▶ **Check rated voltages and terminal arrangements in each product prior to its wiring process.** Applying incorrect voltages other than rated voltages and misarrangement among terminals may cause fire or malfunctions.
- ▶ **Secure terminal screws tightly applying with specified torque.** If the screws get loose, short circuit, fire or abnormal operation may be caused. Securing screws too tightly will cause damages to the module or malfunctions, short circuit, and dropping.
- \*
  - ▶ **Be sure to earth to the ground using Class 3 wires for PE terminals which is exclusively used for PLC.** If the terminals not grounded correctly, abnormal operation or electric shock may be caused.
  - ▶ **Don't let any foreign materials such as wiring waste inside the module while wiring,** which may cause fire, damage on the product or abnormal operation.
  - ▶ **Make sure that pressed terminals get tighten following the specified torque. External connector type shall be pressed or soldered using proper equipments.**

## Safety Instructions for test-operation and maintenance

### **Warning**

- ▶ **Don't touch the terminal when powered.** Electric shock or abnormal operation may occur.
- ▶ **Prior to cleaning or tightening the terminal screws, let all the external power off including PLC power.** If not, electric shock or abnormal operation may occur.
- ▶ **Don't let the battery recharged, disassembled, heated, short or soldered.** Heat, explosion or ignition may cause injuries or fire.

### **Caution**

- ▶ **Do not make modifications or disassemble each module.** Fire, electric shock or abnormal operation may occur.
- ▶ **Prior to installing or disassembling the module, let all the external power off including PLC power.** If not, electric shock or abnormal operation may occur.
- ▶ **Keep any wireless equipment such as walkie-talkie or cell phones at least 30cm away from PLC.** If not, abnormal operation may be caused.
- ▶ **When making a modification on programs or using run to modify functions under PLC operations, read and comprehend all contents in the manual fully.** Mismanagement will cause damages to products and accidents.
- ▶ **Avoid any physical impact to the battery and prevent it from dropping as well.** Damages to battery may cause leakage from its fluid. When battery was dropped or exposed under strong impact, never reuse the battery again. Moreover skilled workers are needed when exchanging batteries.

## Safety Instructions for waste disposal

 **Caution**

- ▶ **Product or battery waste shall be processed as industrial waste.** The waste may discharge toxic materials or explode itself.

# Revision History

Version	Date	Remark	Revised position
V 1.0	2006.5	1. First Edition	-
V1.1	2009.6	1. Added contents about XGI/XGR CPU	5-1~5-26, 6-1~6-11, 7-1~7-22, 8-1~8-7
V1.2	2013.1	1. General specifications are modified 2. Terminal block is added 3. An error is modified	Ch.2 Ch.3 Ch.3, Ch.7
V1.3	2015.7	1. Domain address and CI changed 2. General specifications changed by reason of changed IEC specifications	2-1
V1.4	2020.7	1. Format and contents modification according to the change of company name(LSIS → LS ELECTRIC)	
V1.5	2024.6	1. Change of warranty period and scope	



Thank you for purchasing PLC of LS ELECTRIC Co., Ltd.

Before use, make sure to carefully read and understand the User's Manual about the functions, performances, installation and programming of the product you purchased in order for correct use and importantly, let the end user and maintenance administrator to be provided with the User's Manual.

The User's Manual describes the product. If necessary, you may refer to the following description and order accordingly. In addition, you may connect our website (<http://www.ls-electric.com/>) and download the information as a PDF file.

Relevant User's Manuals

Title	Description
XG5000 User's Manual (for XGK, XGB)	XG5000 software user manual describing online function such as programming, print, monitoring, debugging by using XGK, XGB CPU
XG5000 User's Manual (for XGI, XGR)	XG5000 software user manual describing online function such as programming, print, monitoring, debugging by using XGI, XGR CPU
XGK/XGB Instructions & Programming User's Manual	User's manual for programming to explain how to use instructions that are used PLC system with XGK, XGB CPU.
XGI/XGR/XEC Instructions & Programming User's Manual	User's manual for programming to explain how to use instructions that are used PLC system with XGI, XGR, XEC CPU.
XGK CPU User's Manual (XGK-CPUA/CPUE/CPUH/CPUS/CPUU)	XGK-CPUA/CPUE/CPUH/CPUS/CPUU user manual describing about XGK CPU module, power module, base, IO module, specification of extension cable and system configuration, EMC standard
XGI CPU User's Manual (XGI-CPUU/CPUH/CPUS)	XGI-CPUU/CPUH/CPUS user manual describing about XGI CPU module, power module, base, IO module, specification of extension cable and system configuration, EMC standard
XGR redundant series User's Manual	XGR- CPUH/F, CPUH/T user manual describing about XGR CPU module, power module, extension drive, base, IO module, specification of extension cable and system configuration, EMC standard

# © Table of Content ©

## Chapter 1 Introduction ..... 1-1 ~ 1-3

- 1.1 Features ..... 1-1
- 1.2 Terms and Definition ..... 1-2
  - 1.2.1 Analog quantity - A ..... 1-2
  - 1.2.2 Digital quantity - D ..... 1-2
  - 1.2.3 Thermocouple sensor ..... 1-3
  - 1.2.4 Disconnection detection..... 1-3
  - 1.2.5 Compensating cable ..... 1-3
  - 1.2.6 Thermo electromotive force ..... 1-3
  - 1.2.7 Reference Junction Compensation (RJC) ..... 1-3

## Chapter 2 Specification ..... 2-1 ~ 2-17

- 2.1 General Specifications ..... 2-1
- 2.2 Performance Specifications ..... 2-2
- 2.3 Names and Roles of Parts ..... 2-3
- 2.4 Characteristics of Thermocouple Temperature Sensor Input Module ... 2-4
  - 2.4.1 Temperature conversion characteristic ..... 2-9
  - 2.4.2 Conversion velocity ..... 2-9
  - 2.4.3 Preciseness ..... 2-10
  - 2.4.4 Temperature display ..... 2-10
  - 2.4.5 Scaling function ..... 2-11
  - 2.4.6 Disconnection detection function ..... 2-11
  - 2.4.7 Sensor connection ..... 2-12
- 2.5 Input Module Function of Thermocouple Temperature Sensor ..... 2-13
  - 2.5.1 Average function ..... 2-13
  - 2.5.2 Filter function ..... 2-15
  - 2.5.3 Alarm function ..... 2-16
  - 2.5.4 Max./Min. display ..... 2-17

## **Chapter 3 Installation and Wiring ..... 3-1 ~ 3-2**

<b>3.1 Installation</b> .....	3-1
3.1.1 Installation environment .....	3-1
3.1.2 Cautions in handling .....	3-1
<b>3.2 Wiring</b> .....	3-2
3.2.1 Cautions in wiring .....	3-2
3.2.2 Wiring example .....	3-2
3.2.3 No. of terminal block .....	3-3

## **Chapter 4 Operation Setting and Monitor ..... 4-1 ~ 4-18**

<b>4.1 Operation Setting Procedure</b> .....	4-1
<b>4.2 Operation Parameter Setting</b> .....	4-2
4.2.1 Setting items .....	4-2
4.2.2 How to use [I/O parameters] .....	4-3
<b>4.3 Functions of Special Module Monitoring</b> .....	4-9
<b>4.4 Precautions</b> .....	4-10
<b>4.5 Special Module Monitoring</b> .....	4-11
4.5.1 Run [Special Module Monitoring] .....	4-11
4.5.2 How to use [Special Module Monitoring] .....	4-11
<b>4.6 Automatic Registration of U Device</b> .....	4-16
4.6.1 Automatic registration of U device .....	4-16
4.6.2 Save variables .....	4-17
4.6.3 View variables in the program .....	4-17

## **Chapter 5 Configuration and Function of Internal Memory (For XGK) ..... 5-1 ~ 5-27**

<b>5.1 Configuration of Internal Memory</b> .....	5-1
5.1.1 I/O data of thermocouple I/O module .....	5-1
5.1.2 Operation parameter setting area (use of PUT/PUPT) .....	5-4
5.1.3 Other data monitoring area (use of GET/GETP) .....	5-6
<b>5.2 Function of Internal memory</b> .....	5-7
5.2.1 Module status flag (UXY.00, X: base number, Y: slot number) .....	5-7

5.2.2 Channel status flag (UXY.00, X: base number, Y: slot number) ..... 5-7

5.2.3 Process alarm output flag (UXY.00, X: base number, Y: slot number) ..... 5-8

5.2.4 Rate - change alarm output flag ..... 5-8

5.2.5 Channel temperature conversion value ..... 5-9

5.2.6 Channel scale operation value ..... 5-10

5.2.7 Min./Max. channel temperature conversion value ..... 5-10

5.2.8 Data upload time ..... 5-11

5.2.9 Command contact point ..... 5-11

**5.3 Operation Parameter Setting Area ..... 5-12**

5.3.1 Designating channel (Address0); Channel status ..... 5-12

5.3.2 Sensor type setting area (Address 1~4); Sensor status ..... 5-13

5.3.3 Temperature metric system indication area (Address5); Temp.unit ..... 5-13

5.3.4 Filter value setting area (Address 6~9); Filter constant ..... 5-14

5.3.5 Averaging method setting area (Address 10~13); Average processing ..... 5-15

5.3.6 Averaging setting area (Address 14~17); Average value ..... 5-17

5.3.7 Scale type setting area (Address 18); Scaling data type ..... 5-18

5.3.8 Min./Max. Scale range setting area (Address 19~26); Scaling Min./Max. value ..... 5-19

5.3.9 Process alarm boundary value setting area (Address 27~42); Process alarm H.H Limit,  
Process alarm H. Limit, Process alarm L.Limit, Process alarm L.L.Limit ... 5-20

5.3.10 Process alarm Hysteresis setting area (Address 43~46); Process alarm HYS... 5-21

5.3.11 Alarm type setting area of rate-change-alarm (Address 47); RCA type ..... 5-22

5.3.12 Rate-change-Alarm H/L Boundary Value Setting Area(Address 48~55); RCA high limit,  
RCA low limit ..... 5-23

5.3.13 Rate-change alarm detection period setting area (Address 56~59)..... 5-24

**5.4 Other Data Monitoring setting area ..... 5-25**

5.4.1 Setting error information output area (Address 60~63) ..... 5-25

5.4.2 Rate-change alarm change (Gradient) output area (Address 64~67) ..... 5-26

5.4.3 Sensor disconnection information output area (Address 68~71) ..... 5-27

5.4.4 Cold junction compensation temperature output area (Address 72~75) ... 5-27

**Chapter 6 Programming (For XGK) ..... 6-1 ~ 6-11**

**6.1 Read/Write Operation Parameter setting area ..... 6-1**

6.1.1 Read operation parameter setting area (GET, GETP instruction) ..... 6-1

6.1.2 Write operation parameter area (PUT, PUTP instruction) .....	6-2
<b>6.2 Basic Program</b> .....	6-3
<b>6.3 Application Program</b> .....	6-5
6.3.1 Temperature conversion value determination program (I/O slot fixation point assignment: 64 point) .....	6-5
6.3.2 CH data monitor program (I/O slot fixation point assignment: 64 points) .....	6-8
6.3.3 Other data monitor program .....	6-10

## **Chapter 7 Configuration and Function of Internal Memory (For XGI/XGR) ..... 7-1 ~ 7-22**

<b>7.1 Global Variable (Data area)</b> .....	7-1
7.1.1 Conversion data IO area configuration .....	7-1
7.1.2 How to use global variable .....	7-4
<b>7.2 PUT/GET Function Block use area (Parameter area)</b> .....	7-11
7.2.1 PUT/GET Function Block use area (Parameter area) .....	7-11
7.2.2 Other data monitor area (Using GET/GETP) .....	7-12
7.2.3 PUT/GET instruction .....	7-13
7.2.4 Example using PUT/GET instruction .....	7-15

## **Chapter 8 Programming (For XGI/XGR) ..... 8-1 ~ 8-7**

<b>8.1 Basic Program</b> .....	8-1
8.1.1 Program to sort A/D converted value in size .....	8-1
8.1.2 Program to monitor channel data .....	8-4
8.1.3 Other data monitor program .....	8-7

## **Chapter 9 Troubleshooting ..... 9-1 ~ 9-6**

<b>9.1 LED Indication by Errors</b> .....	9-1
<b>9.2 Diagnostics and Measures</b> .....	9-2
9.2.1 Run LED quickly flickers. ....	9-2
9.2.2 Run LED slowly flickers. ....	9-2
9.2.3 Run LED turns off .....	9-3
9.2.4 ALM LED flickers .....	9-4
9.2.5 CPU module cannot read temperature conversion value .....	9-4

**9.3 Error Code** ..... 9-5  
9.3.1 Error codes of abnormal sensor connection (in case of sensor disconnection) ..... 9-5  
9.3.2 Error codes of abnormal module H/W (contact the close agency or the company) ... 9-5

**Appendix 1 Terminology** ..... **A1-1 ~ A1-2**

**Appendix 2 Thermo Electromotive Force and Compensating Cable** ..... **A2-1 ~ A2-7**

**Appendix 3 Dimension** ..... **A3-1**

**Warranty and Environmental Policy**



# Chapter 1 Introduction

The operating manual describes the dimensions, handling, programming and others of insulation thermocouple temperature sensor ("XGF-TC4S") input module, which is used with XGK/I/R CPU module. XGF-TC4S is the module to convert the temperature data detected by 9 kinds of thermocouple sensor (K/J/E/T/B/R/S/N/C) into 16 bits binary data, yielding digital values. Especially, the module is insulated between channels as well as between PLC and channel.

## 1.1 Features

- 1) Modules depending on application  
XGF-TC4S: 4 Ch. Input (inter-channel insulation type)
- 2) 9 sensors available  
K / J / E / T / B / R / S / N / C
- 3) Detection of disconnection  
It can detect and display any disconnection among thermocouple temperature sensor, compensating cable and modules.
- 4) Displaying temperature conversion down to one decimal place  
It means temperature may be displayed in Fahrenheit or Celsius.
- 5) Temperature conversion is scaled into the pre-set 16 bit binary data(it may be used for additional data as well as temperature)  
Scale operation output of temperature conversion is available within -32768~32767 / 0~65535.
- 6) Various additional functions  
Filtering, average function(time/frequency/movement), alarm(process/input change), max/min detection function
- 7) GUI(Graphical user interface) Operation parameter setting/monitoring by means of GUI(graphical user interface)  
User convenience is intensified as the operation parameter setting is available by the user-oriented [I/O Parameter Setting], instead of the existing commands. Using [I/O Parameter Setting] may reduce the sequence program. In addition, temperature conversion may be easily monitored through [special module monitoring] function



**1.2 Terms and Definition**

**1.2.1 Analog quality – A**

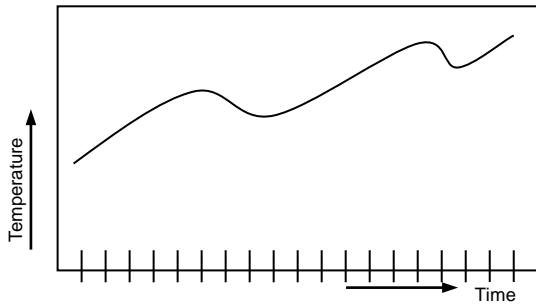

[Fig 1.1] Analog quality

Analog quality is referred to continuously changing amount such as voltage, current, temperature, velocity, pressure and flow.

Temperature, for instance, is continuously changing over the time as seen in Figure 1.1. It can make it possible to treat changing temperature as digital quality in PCL by using thermocouple temperature sensor input module.

**1.2.2 Digital quality - D**

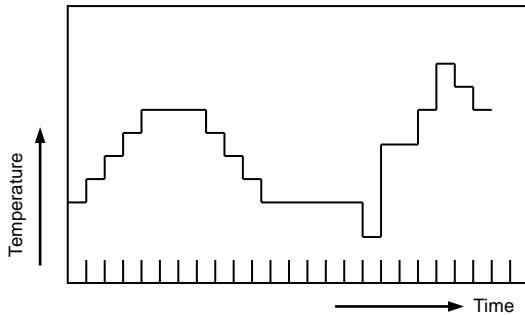

[Fig 1.2] Digital quality

Digital quality is referred to not continuously changing amount as Fig 1.2 showing the number of person as 0, 1, 2, 3.... On/Off signal is represented as digital quality of 0 and 1.

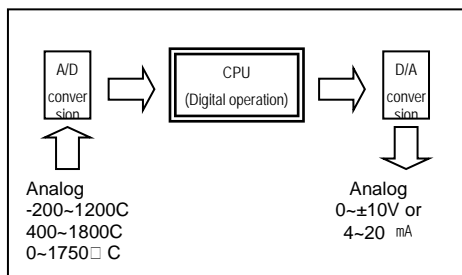

[Fig 1.3] Process in PLC

CPU module may not have any value of analog amount directly entered in order for digital quality operation. Therefore, analog amount should be entered into CPU after being converted to digital amount. In addition, the digital quality of CPU should be converted into analog quality in order to output any analog quality.

### 1.2.3. Thermocouple sensor

It refers to the temperature sensor which is made of two different metals as a joint and generates electromotive force with flowing thermoelectric current if given with a temperature gap of junction, yielding thermocouple effect.

The amount of electromotive force is defined depending on the type of metal bonded and the temperature of both junctions but it is not affected by shape of metal, dimension or temperature change.

### 1.2.4. Disconnection detection

It refers to the function to execute disconnection detection when part of compensating cable or thermocouple is disconnected because excessive voltage out of range is input.

### 1.2.5. Compensating cable

Cable to compensate the tolerance due to the distance between input thermocouple terminal and thermocouple input module (temperature change) and in which both terminals have similar thermo electromotive force between 90 ~ 150°C.

### 1.2.6. Thermo electromotive force

Thermo electromotive force for thermocouple temperature has non-linear characteristics. (the change of thermo electromotive force, which occurs every time it is changed degree by degree, is not regular)

Therefore, it processes the non-linear characteristics to linear in the module

### 1.2.7. Reference junction compensation (RJC)

Thermocouple sensor has a feature that thermo electromotive force varies, depending on the temperature of a part measuring electromotive force. Since the thermo electromotive force table of standards is based on 0°C, it refers to compensate the gap between the current temperature and the actual reference temperature (0°C).



## Chapter 2 Specification

### 2.1 General Specifications

The general specifications of XGT series are displayed in Table 2.1.

No.	Item	Specifications	Related specifications		
1	Ambient temperature	0 ~ 55 °C	-		
2	Storage temperature	-25 ~ +70 °C	-		
3	Ambient humidity	5 ~ 95%RH (Non-condensing)	-		
4	Storage humidity	5 ~ 95%RH (Non-condensing)	-		
5	Vibration resistance	Occasional vibration		-	
		Frequency	Acceleration	Amplitude	How many times
		5 ≤ f < 8.4Hz	-	3.5mm	
		8.4 ≤ f ≤ 150Hz	9.8 m/s <sup>2</sup> (1G)	-	10 times each directions (X, Y and Z)
		For continuous vibration			
		Frequency	Acceleration	Amplitude	
			5 ≤ f < 8.4Hz	-	1.75mm
	8.4 ≤ f ≤ 150Hz	4.9 m/s <sup>2</sup> (0.5G)	-		
6	Shock resistance	<ul style="list-style-type: none"> <li>Peak acceleration: 147 m/s<sup>2</sup>(15G)</li> <li>Duration: 11ms</li> <li>Half-sine, 3 times each direction per each axis</li> </ul>	IEC61131-2		
7	Noise resistance	Square wave Impulse noise	AC: ± 1,500V DC: ± 900V	LS ELECTRIC standard	
		Electrostatic discharge	Voltage : 4kV (contact discharging)		IEC 61131-2, IEC 61000-4-2
		Radiated electromagnetic field noise	80 ~ 1,000 MHz, 10V/m		IEC 61131-2, IEC 61000-4-3
		Fast transient /bust noise	Segment	Power supply module	Digital/analog input/output communication interface
Voltage	2kV		1kV		
8	Environment	Free from corrosive gasses and excessive dust	-		
9	Altitude	Up to 2,000 ms	-		
10	Pollution degree	Less than equal to 2	-		
11	Cooling	Air-cooling	-		

[Table 2.1] General Specifications

#### Remark

- IEC (International Electrotechnical Commission)  
: An international private institute establishing electric/electronic fields
- Contamination  
: As an indicator to represent the contamination of operating environment determining the insulation performance of a device, contamination 2 means the status with non conductive contamination. However, it may have temporary conduction depending on dewing.

**2.2. Performance Specifications**

Item	Specifications	
No. of input CH	4 CH	
Type of input sensor	K,J,E,T,B,R,S,N,C	JIS C1602-1995 , ITS-90
Range of input temperature	K	-250 ~ 1350℃
	J	-200 ~ 1200℃
	E	-250 ~ 1000℃
	T	-250 ~ 400℃
	B	400 ~ 1800℃
	R	-50 ~ 1750℃
	S	-50 ~ 1750℃
	N	-270 ~ 1300℃
Digital output	Temp. display(unit of 0.1)	Displaying down to one decimal place (0.1℃)
	Scaling display (user-defined scaling)	0 ~ 65535
		-32768 ~ 32767
Preciseness	Ambient temperature(25℃)	±0.1% (allowable for some section up to 1% of measurable temperature range by sensors)
	Temperature coefficient (range of operating temp)	±100 ppm/℃
Conversion velocity	40ms / channel	
Insulation method	Inter-channel	Insulation
	Terminal – PLC power	Insulation (Photo-Coupler)
Cold junction compensation	Automatic compensation by RJC sensing (PT100)	
	Compensation degree	±1.0℃
Function	Averaging function	Time average (320~64000 ms)
		Frequency average (2~64000 times)
		Moving average (2~100)
	Alarm function	Process alarm
		Gradient alarm
		Disconnection detection
Filter function	Digital filter (160~64000 ms)	
Max./Min. display	Display Max./Min.	
Terminal block	18-point terminal	
Current consumption	5V: 610mA	
Weight	150g	

[Table 2.2] Performance Specifications

**Remark**

- 1) When using XGR system  
- In XGR system, TC module can be equipped at only extension base.

**2.3 Names and Roles of Parts**

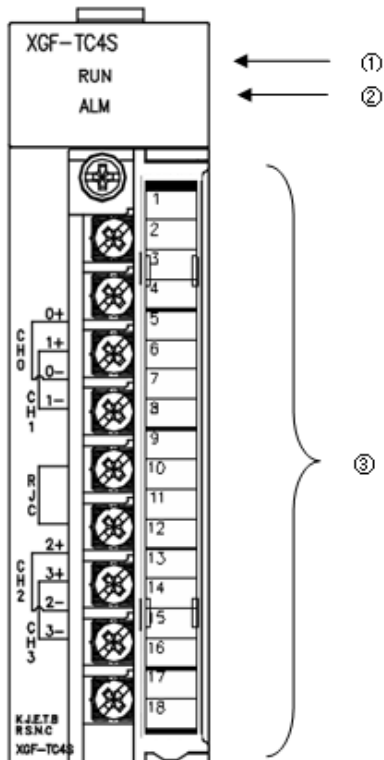

No.	Description
①	<p><b>RUN LED</b></p> <p>▶ Displaying the operation status of XGF-TC4S module H/W (displaying error)</p> <p>On : normal module H/W                      Blink : erroneous module H/W                      Off : DC5V disconnection or abnormal module H/W</p>
②	<p><b>ALM LED</b></p> <p>▶ Displaying the input/channel operating status of XGF-TC4S module (displaying warning)</p> <p>Blink : input disconnection                      Off : normal input status</p>
③	<p><b>Terminal block</b></p> <p>▶ It is designed to connect thermocouple temperature sensor to XGF-TC4S module.</p> <p>PT100 for compensating 9 types thermocouple sensors and cold junction (module supplied)</p>

## 2.4 Characteristics of Thermocouple Temperature Sensor Input module

XGF-TC4S module directly connects 9 types of thermocouple sensors and features as follows.

- (1) Thermocouple K (JIS C1602-1995) : -250 °C (-6404 μV) ~ 1350 °C (54138 μV)

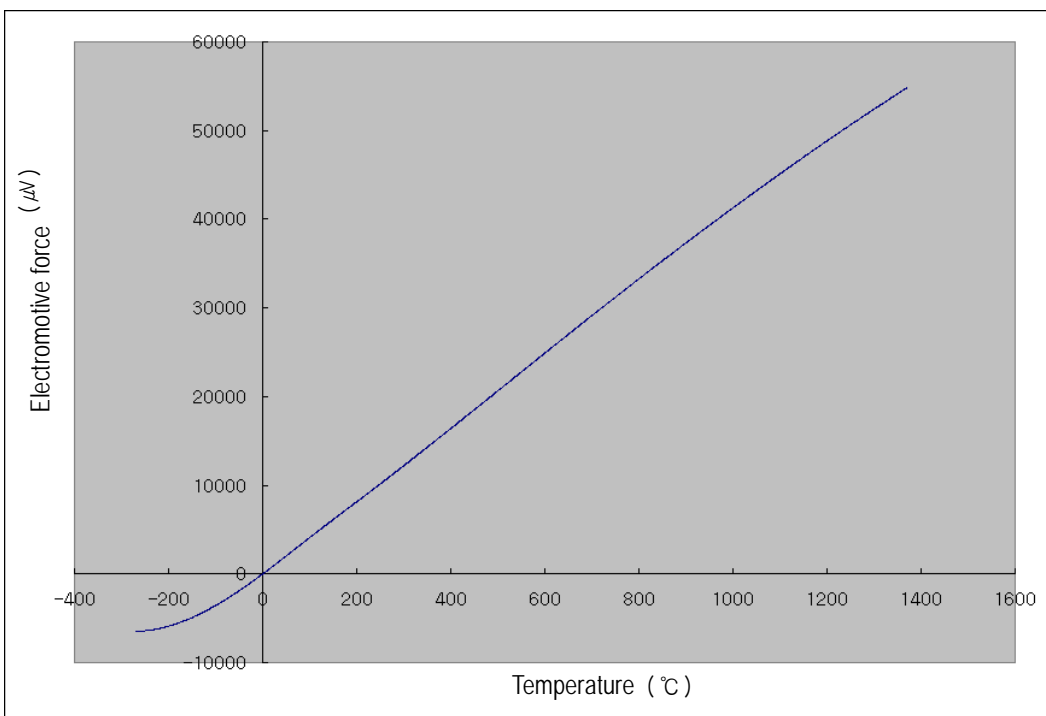

- (2) Thermocouple J (JIS C1602-1995) : -200 °C (-7890 μV) ~ 1200 °C (69553 μV)

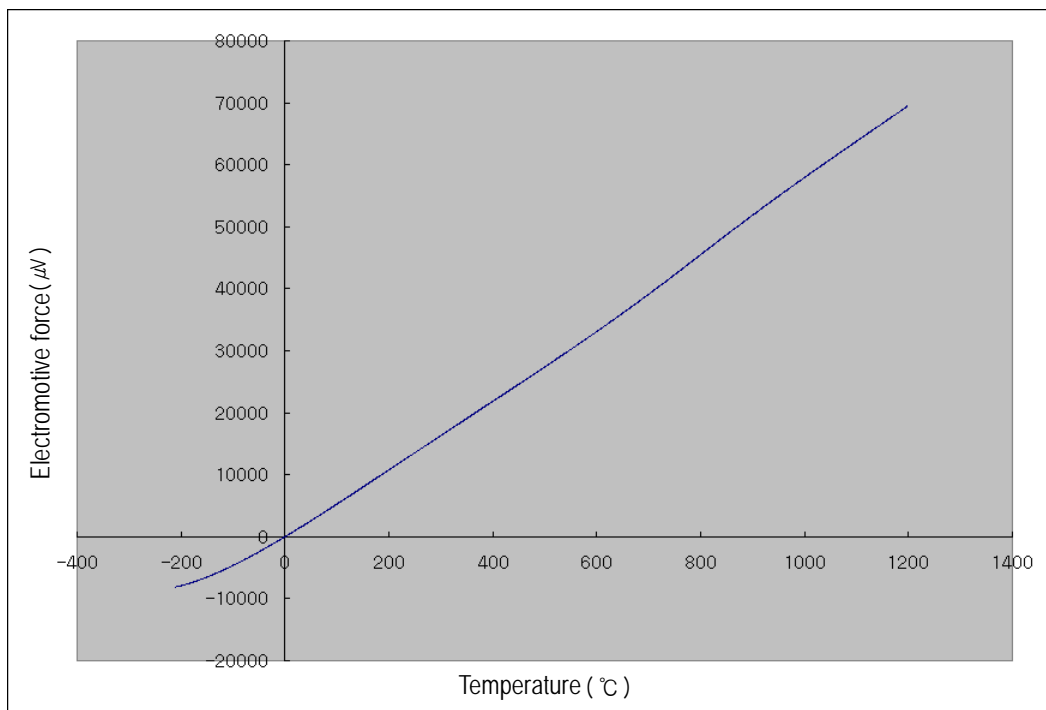

## Chapter 2 Specification

---

(3) Thermocouple E (JIS C1602-1995) : -250 °C (-9718  $\mu\text{V}$ ) ~ 1000 °C (76373  $\mu\text{V}$ )

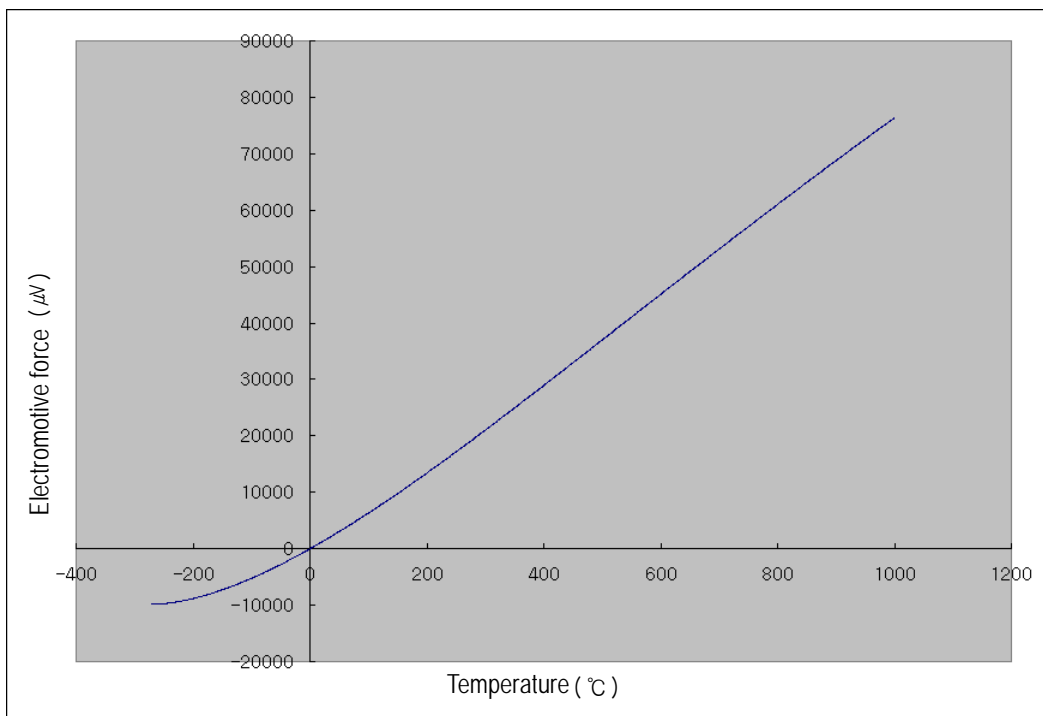

(4) Thermocouple T (JIS C1602-1995) : -250 °C (-6180  $\mu\text{V}$ ) ~ 400 °C (20872  $\mu\text{V}$ )

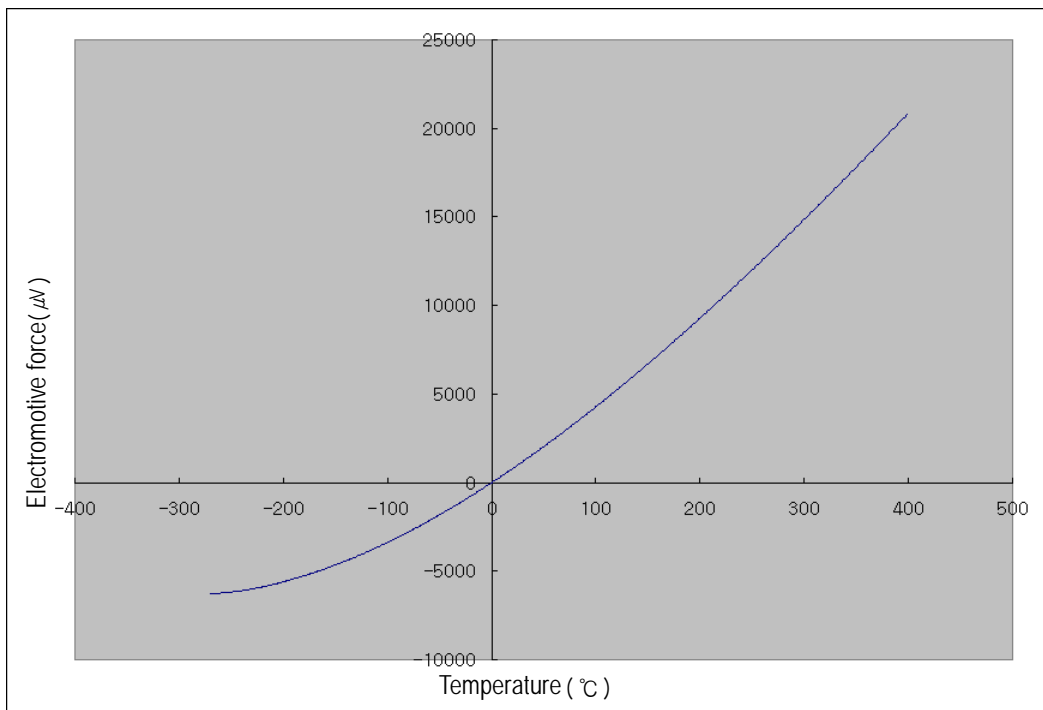



## Chapter 2 Specification

---

(5) Thermocouple B (JIS C1602-1995) : 400 °C (787  $\mu\text{V}$ ) ~ 1800 °C (13591  $\mu\text{V}$ )

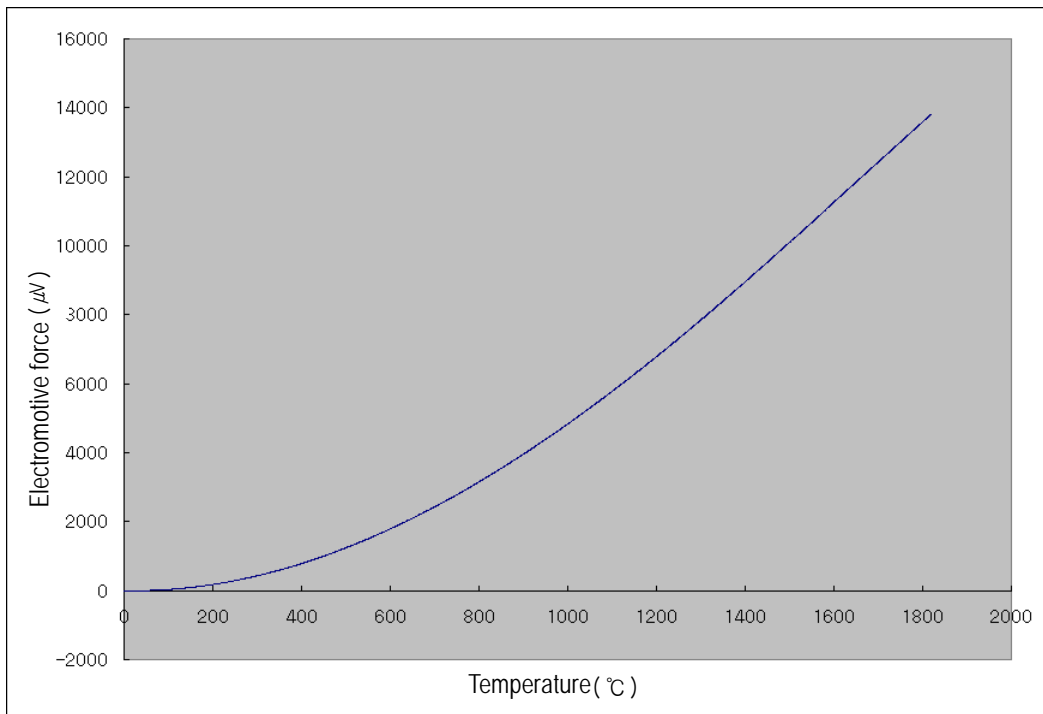

(6) Thermocouple R (JIS C1602-1995) : -50 °C (-226  $\mu\text{V}$ ) ~ 1750 °C (20877  $\mu\text{V}$ )

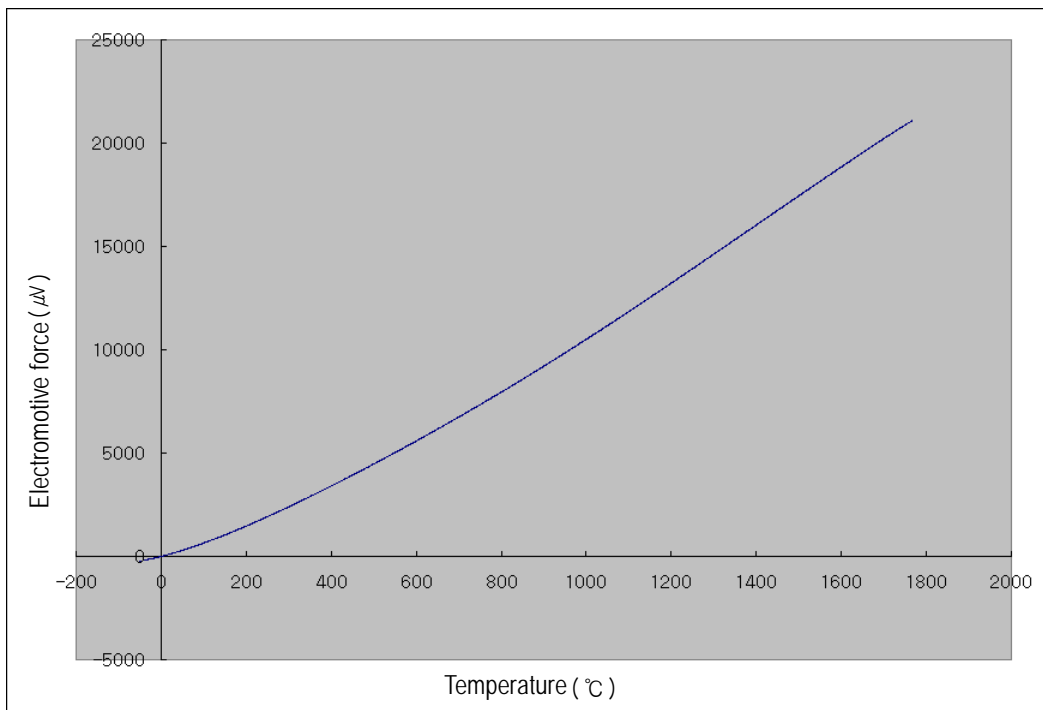

## Chapter 2 Specification

---

(7) Thermocouple S (JIS C1602-1995) : -50 °C(-236  $\mu\text{V}$ ) ~ 1750 °C(18503  $\mu\text{V}$ )

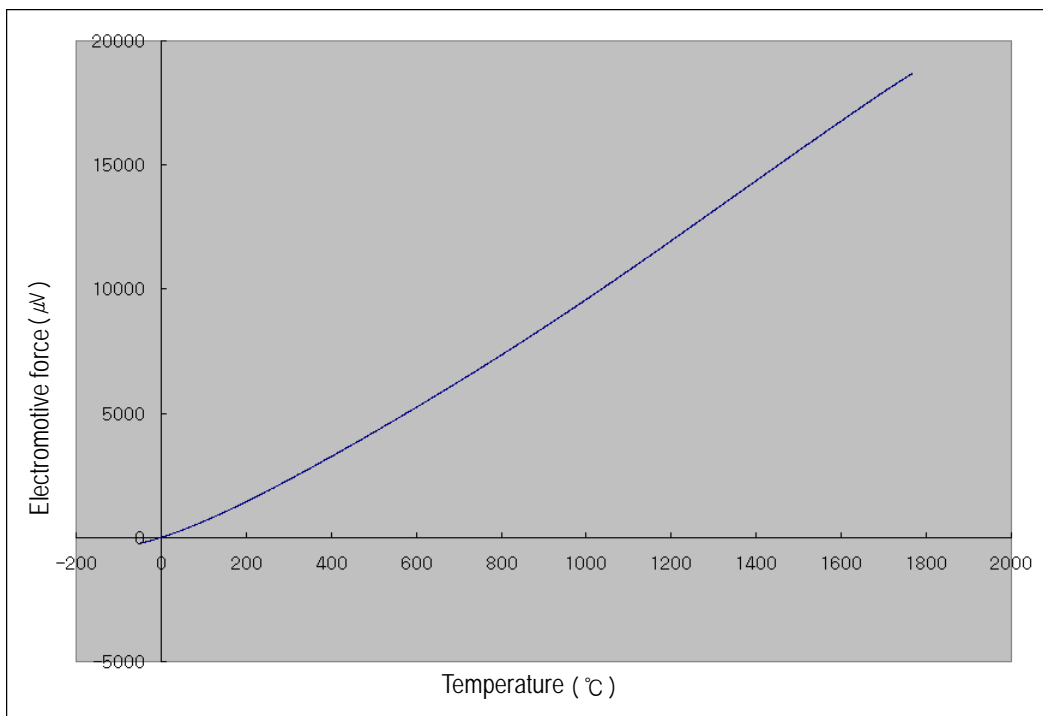

(8) Thermocouple N (JIS C1602-1995) : -270 °C(-4345  $\mu\text{V}$ ) ~ 1300 °C(47513  $\mu\text{V}$ )

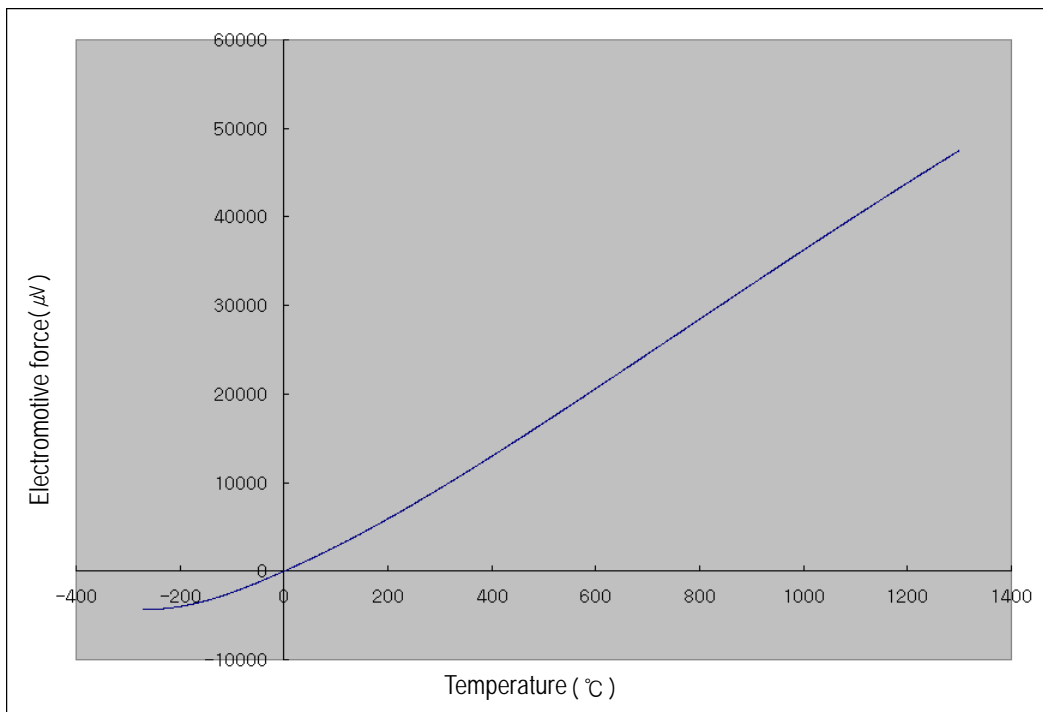

## Chapter 2 Specification

---

(9) Thermocouple C (ITS-90) : 0 °C (0  $\mu\text{V}$ ) ~ 2300 °C (36922  $\mu\text{V}$ )

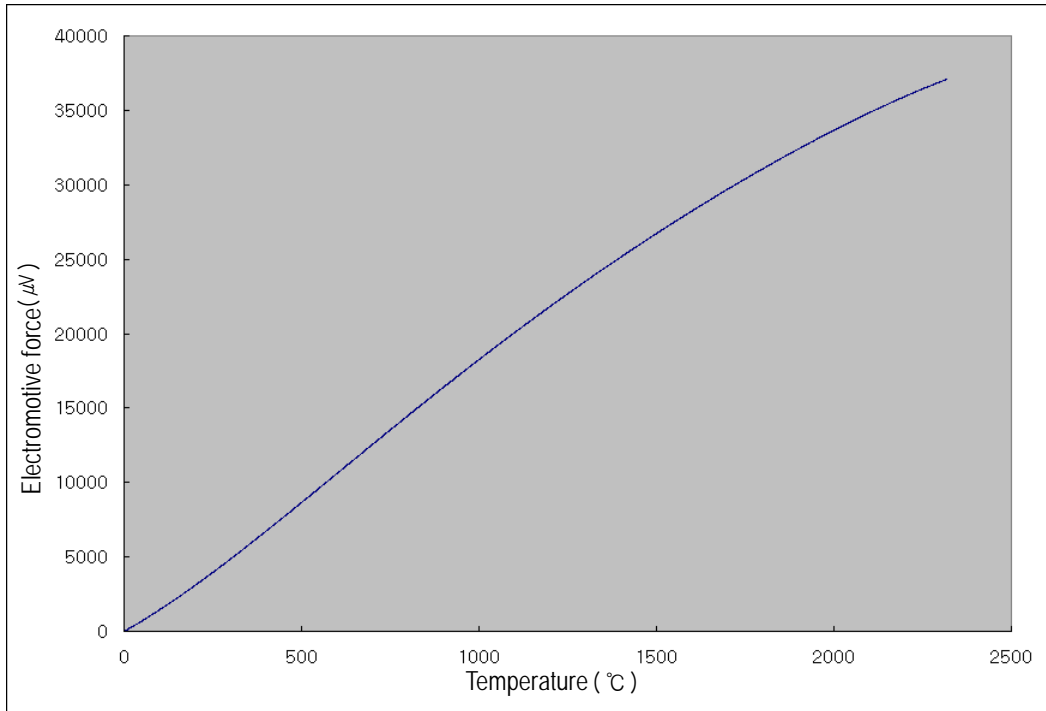

### Remark

Thermocouple characteristics: thermocouple sensor measures temperature by using fine voltage (electromotive force), which occurs when applying temperature gradient to a junction between two different metals.

The temperature-electromotive force relation specification of normal thermocouple sensor provides the electromotive force, which is measured when a sensor's measuring point is at  $0^{\circ}\text{C}$ . On that account, when measuring temperature by using thermocouple sensor, cold junction compensation (reference junction compensation, RJC) is used. (built-in function of temperature measuring module).

### 2.4.1 Temperature conversion characteristics

Thermocouple input module converts the thermocouple input with non-linear characteristics into A/D and outputs the temperature conversion that is linearly treated.  
Temperature conversion to thermocouple input has non-linear characteristics.

#### Remark

Non-linear characteristics: regarding the relation of temperature( $^{\circ}\text{C}$ ) and electromotive force( $\mu\text{V}$ ) of a thermocouple sensor, electromotive force is different by sections even though temperature changes by a certain amount, which is called 'non-linear characteristics.' As seen in the above graph, it is shown that the relation of temperature and electromotive force is a curve by temperature sections. The module processes the non-linear characteristics table as linear.

### 2.4.2 Conversion velocity

XGF-TC4S has the conversion velocity of 40ms per channel and processes channels in regular sequence channel by channel.  
(Operation/stop of each channel may be designated independently.)

$\therefore$  Process time = 40ms X no. of use channels.

[i.e.] if using 3 channels: process time = 40ms X 3 = 120ms

#### Remark

The conversion velocity of XGF-TC4S module is a cycle that the temperature(electromotive force) entered into terminal strip is converted into digital value and stored in internal memory.

### 2.4.3 Preciseness

The preciseness of XGF-TC4S module depends on the ambient temperature as follows.

Type	Scope(°C)	Ambient temperature (25°C)	Operating temperature (0 ~ 55°C)
K	-250.0 ~ -200.0	±17.0	
	-200.0 ~ 1350.0	±2.6	±2.6
J	-200.0 ~ 1200.0	±2.4	±2.4
E	-250.0 ~ -200.0	±13.5	
	-200.0 ~ 1000.0	±2.3	±2.3
T	-250.0 ~ -200.0	±8.0	
	-200.0 ~ 400.0	±2.0	±2.0
B	400.0 ~ 1800.0	±3.0	±3.0
	-50.0 ~ 0.0	±2.0	±2.0
R	0.0 ~ 1750.0	±19.0	
	-50.0 ~ 0.0	±2.8	±2.8
S	0.0 ~ 1750.0	±16.7	
	-270.0 ~ -200.0	±2.8	±2.8
N	-200.0 ~ 1300.0	±16.7	
	0.0 ~ 2300.0	±2.6	±2.6
C	-250.0 ~ -200.0	±3.3	±3.3

- i.e.) if measuring the temperature 100°C when the temperature of module operation is ambient and K type thermocouple is used, the output range of conversion data is between 100 °C - 2.6 ~ 100 °C + 2.6; that is, 97.4 ~ 102.6 [°C].

#### Remark

- 1) XGF-TC4S module is released from factory after its offset/gain is adjusted by using standard source of each channel. For a module's preciseness, it is prohibited that a user temporarily changes the values.
- 2) XGF-TC4S module has different error within temperature coefficient of 100ppm each time the operation temperature is different by one degree.

### 2.4.4 Temperature display

XGF-TC4S module displays temperature down to one decimal point.

- i.e.) if displaying 123.4°C by converting, the value stored in the internal memory would be 1234. In addition, it may display temperature by Celsius or Fahrenheit, depending on the settings of XGF-TC4S module.

- i.e.) if displaying 100 °C in Fahrenheit, it would be 212 F by using the following formula.

#### Remark

From Celsius to Fahrenheit degree:  $F = \frac{9}{5}C + 32$

From Fahrenheit to Celsius degree:  $C = \frac{5}{9}(F - 32)$

### 2.4.5 Scaling function

XGF-TC4S module has a function to scale value in user-defined range besides temperature.

The scope is classified into two types; 16 bits data type, -32768~32767 and 16 bits data type without mark, 0~65535.

If a user selects one of these two types and sets the range, it displays the temperature through scaling operation.

- i.e.) if scaling with mark is set with -250 ~ 1000 and the temperature measured E type sensor is 500.0°C, the value scaled is as follows.

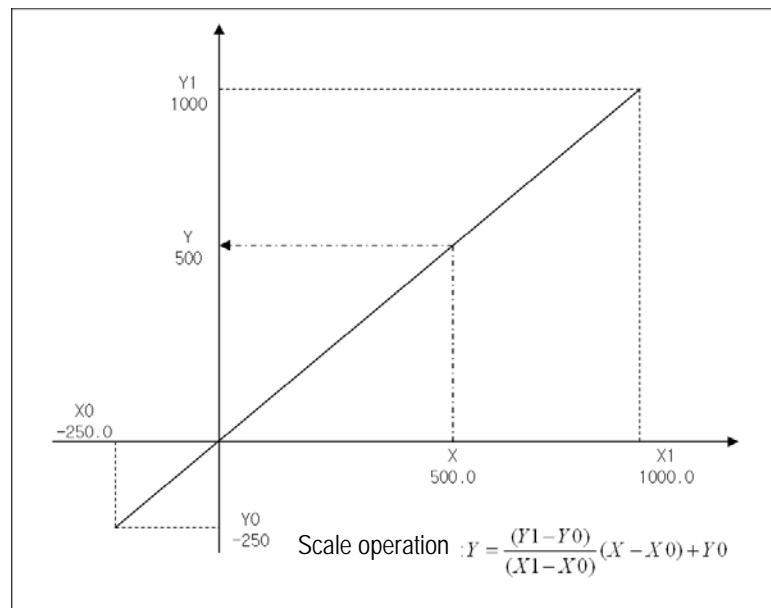

### 2.4.6 Disconnection detection function

XGF-TC4S module measures temperature by directly connecting thermocouple temperature sensor and has the diagnosis function to detect and display any disconnection of a sensor connected.

- 1) If any disconnection occurs between a sensor used/compensating cable and module, LED(ALM) flickers every second and generates error code.  
In addition, LED(ALM) indication flickers every second even though cold junction compensating sensor installed on the module's terminal block is separated or destructed, hindering normal connection.
- 2) Disconnection can be detected by channels. However, it is available for the only channel(s) designated for operation. LED(ALM) is commonly used for every channel. It flickers in case even only one channel is disconnected.
- 3) That the module detects and displays disconnection means that the following cabling path would have partially bad connection, which requires taking measures.

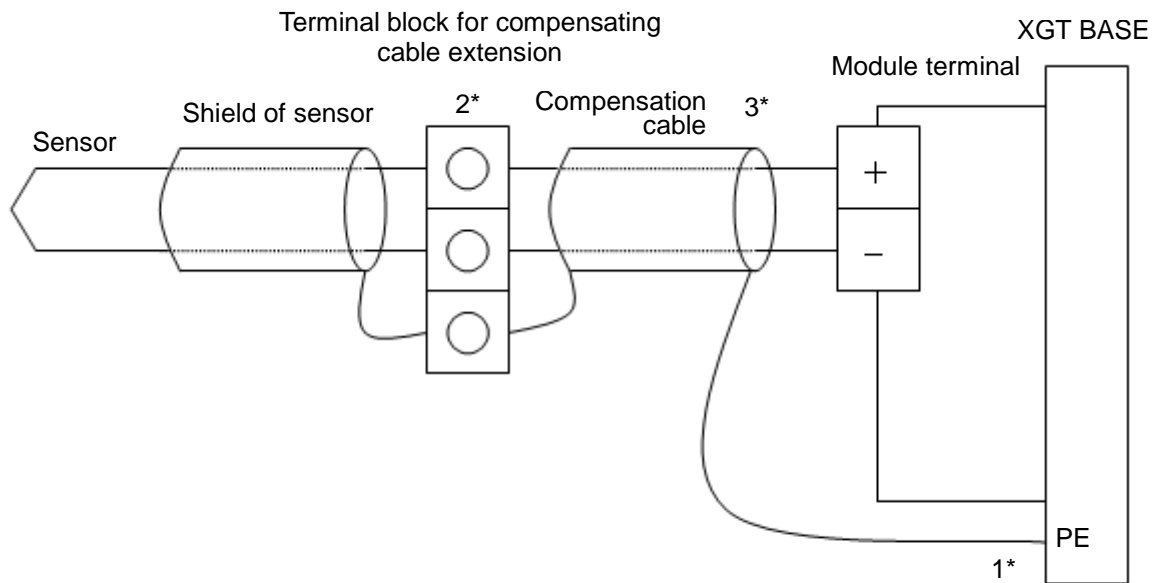

1. In case sensor and compensating cable are shielded, shield connection is possible to PLC PE terminal
2. It is necessary to use extension terminal block of which material is kept at uniform temperature in order to reduce error.
3. Compensating cable should use the same type of sensor, which was used for measuring.

### 2.4.7 Sensor connection

A thermocouple sensor can be directly connected to a terminal of module or be connected to it by using compensating cable (type of cable depends on sensor type. For the further information, contact sensor manufacturer) if the measuring point is far from the module.

**2.5 Input Module Function of Thermocouple Temperature Sensor**

2.5.1 Average function

(1) Time average

It accumulates temperature conversion values of a selected channel and displays the average of the total sum in digital data.

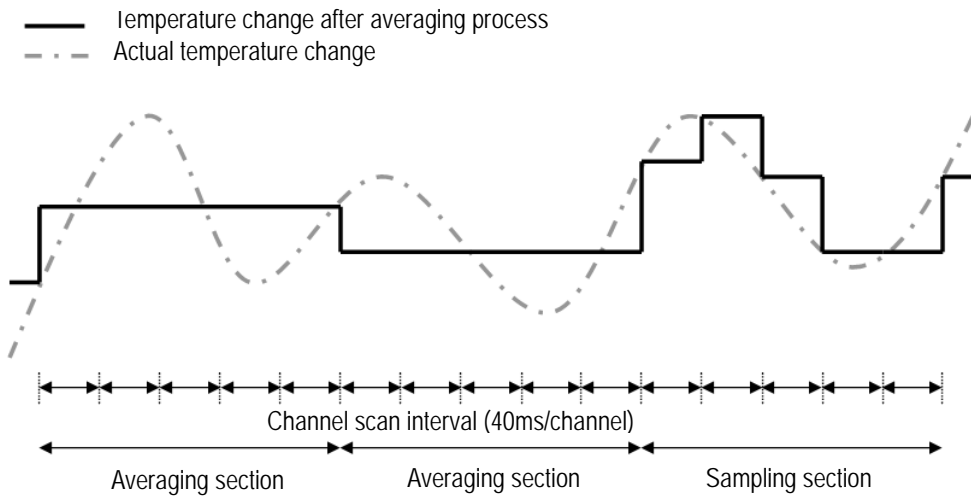

: Setting range of average time = 320 ~ 64000 [ms]

: Frequency of average process for a preset time can be calculated as follows.

$$\text{Average Process Frequency [times]} = \frac{\text{Average time}_{ms}}{\text{No. of channel used} \times 40_{ms}}$$

(2) Averaged frequency

: It accumulates temperature conversion values of a selected channel as many as frequency and displays the average of the total sum in digital data.

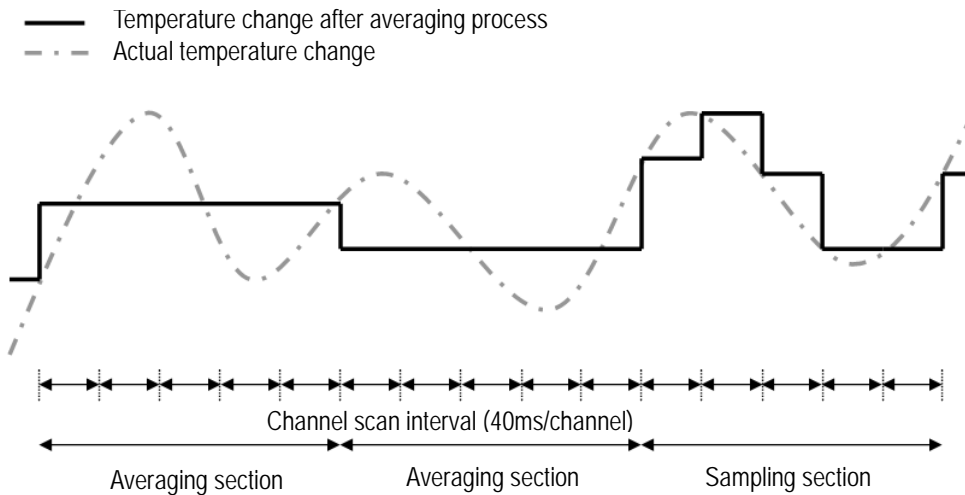



## Chapter 2 Specification

- : Setting range of average frequency = 2 ~ 64000 [times]
- : Average process interval of channel used can be calculated as follows.

$$\text{Average process interval}[ms] = \text{Average frequency} \times \text{No. of channel used} \times 40[ms]$$

### (3) Moving average

- : It accumulates temperature conversion values of a selected channel as many as set and displays the average of the total sum in digital data. In case of the moving average, it outputs average per scan.

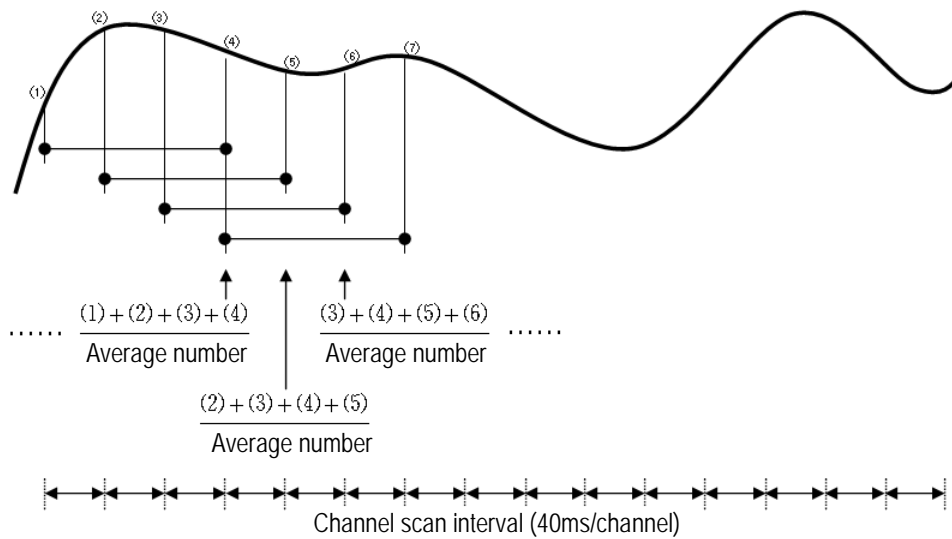

- : Setting range of average number = 2 ~ 100

#### Remark

Out of 3 types of averaging process, time/frequency average characteristically does not output temperature data every conversion time and instead, it keeps a feature to maintain the previous status until it reaches time/average frequency. On the other hand, in case of moving average, it outputs the converted temperature as taking temperature history and average, which are entered previously, every conversion time, so it can obtain relatively faster data response than time/frequency average.

2.5.2 Filter function

: By means of filter value(corrected number) setting temperature conversion of a designated channel, it operates and outputs as follows.

$$\text{Filtered temp. value} = \frac{(\text{previously filtered temp. value} \times \text{filter value}_{\text{ms}}) + (\text{present input temp. value} \times 40_{\text{ms}} \times \text{No. of channel used})}{\text{Filter value}_{\text{ms}} + (40_{\text{ms}} \times \text{No. of channels used})}$$

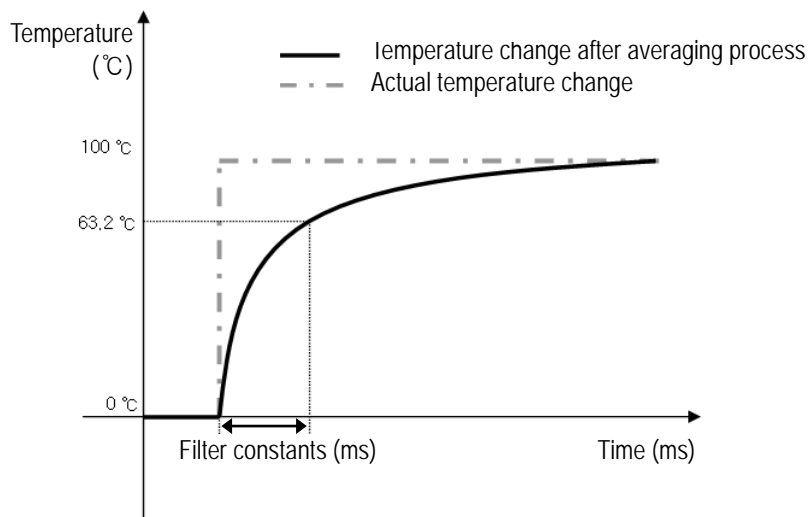

: Setting range of filtering value = 160 ~ 64000 [ms]

**Remark**

Filtering in XGF-TC4S can be processed with one of the foresaid averaging functions simultaneously. If simultaneous process is selected, filtering would be processed first and it averages and output temperature value in digital value. At the moment, the digital data output (temperature) is displayed as the value gained after the final process.

2.5.3 Alarm function

(1) Process alarm function

: Alarm alerts if the temperature conversion value of a selected channel is higher than the temperature preset for alarm(HH, H) or lower than the temperature present for alarm(L, LL).

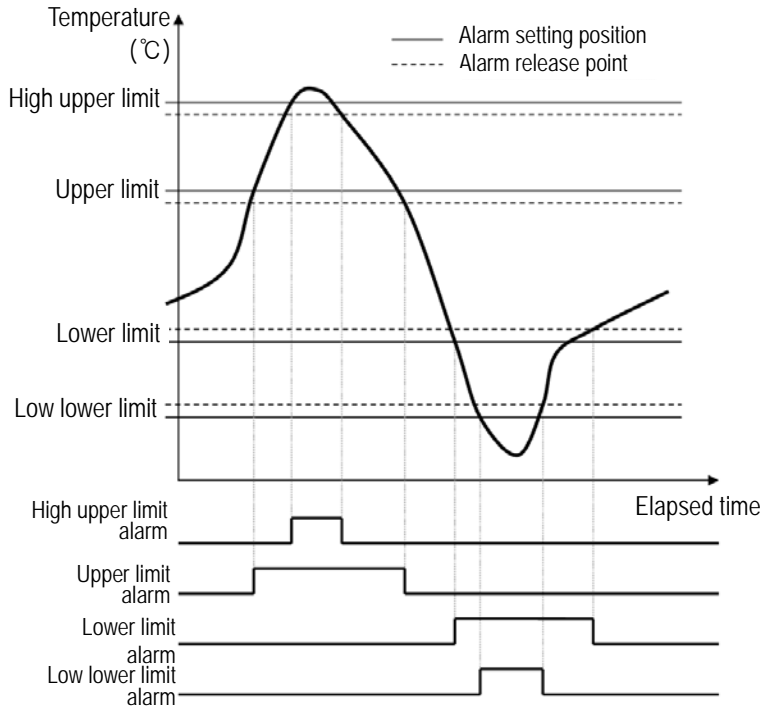

(2) Gradient Alarm Function

: Alarm alerts if the change of temperature conversion value of a selected channel is larger than gradient set for alarming(alarming can be set at two points of L/H limits).

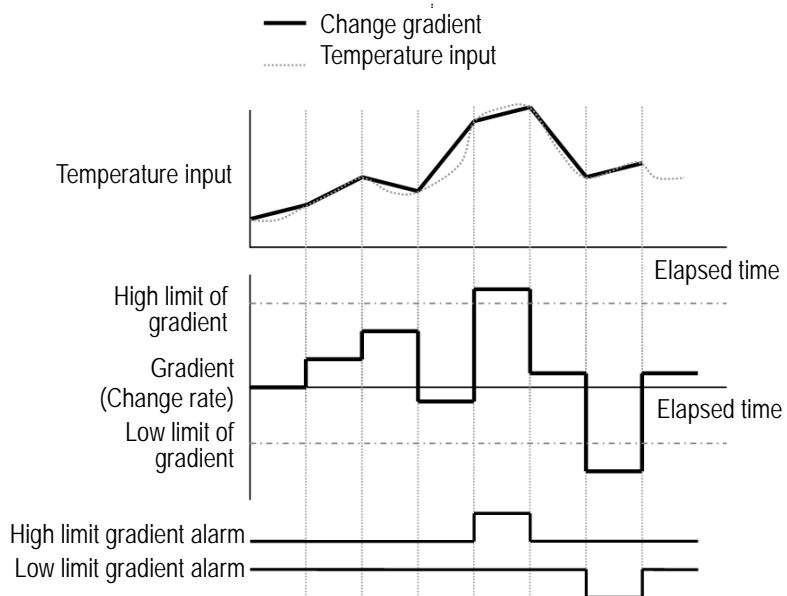

### 2.5.4 Max./Min. display

: It displays maximum/minimum value of temperature conversion value of a selected channel for a selected section (a section allowed for max./min. search)

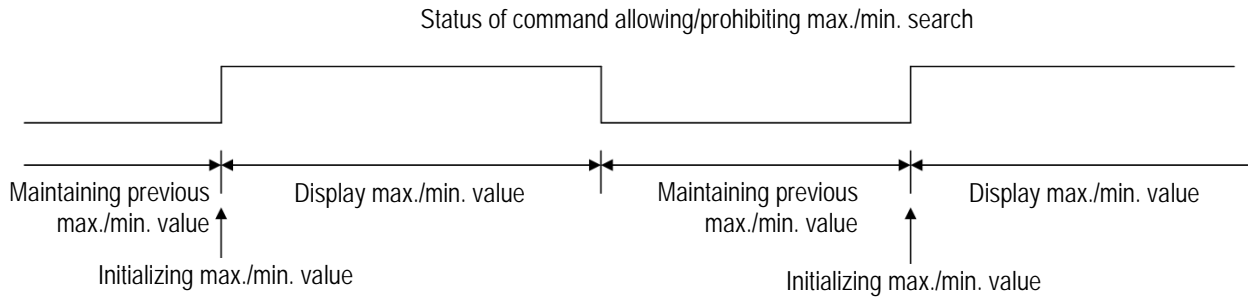



# Chapter 3 Installation and Wiring

## 3.1 Installation

### 3.1.1 Installation environment

Although the device can be installed with high reliance regardless of installation environment, attention should be paid to the followings in order to secure the reliance and stability of the system.

#### 1) Environmental Conditions

- Install on a water-proof and dust-proof control board.
- Place free of continuous impact or vibration.
- Place not directly exposed to direct sunrays.
- Place where dew does not form due to rapid temperature change.
- Place where ambient temperature is maintained between 0-55 °C.

#### 2) Installation Construction

- In case of screw hole processing or wiring construction, wiring dregs should not go into PLC.
- Install on a position easy to access.
- Should not install on the same panel which high voltage device is installed on.
- It should be 50mm and longer distant from duct and modules.
- Should ground in the environment where is not interrupted from noise.

### 3.1.2 Cautions in handling

It describes caution in handling from unpacking module to installation.

- 1) Do not fall or apply excessive impact on it.
- 2) Never attempt to separate PCB from the case.
- 3) Make sure that any impurities including wiring dregs should not go into the upper part of module during wiring work.  
Please remove them If they go into the module.
- 4) Never attempt to attach or detach the module when it is turned on.

### 3.2 Wiring

#### 3.2.1 Cautions in wiring

- 1) Do not place AC power line close to the AUX signal line of the module. To avoid surge or induced noise occurring from AC, make sure to leave a proper space.
- 2) Cable should be selected by considering ambient temperature and allowable current and the max size of cable should be AWG22(0.3mm<sup>2</sup>) and higher.
- 3) If cable is placed too close to any heating device or materials or if it directly contacts oil and similar materials for a long time, it may cause short-circuit, resulting in breakdown and malfunction.
- 4) Check the polarities during terminal strip wiring
- 5) Wiring with high voltage cable or power line may cause induction problem, causing malfunction or trouble.
- 6) XGF-TC4S may use 9 types of thermocouple sensors (K / J / E / T / B / R / S / N / C).

#### 3.2.2 Wiring example

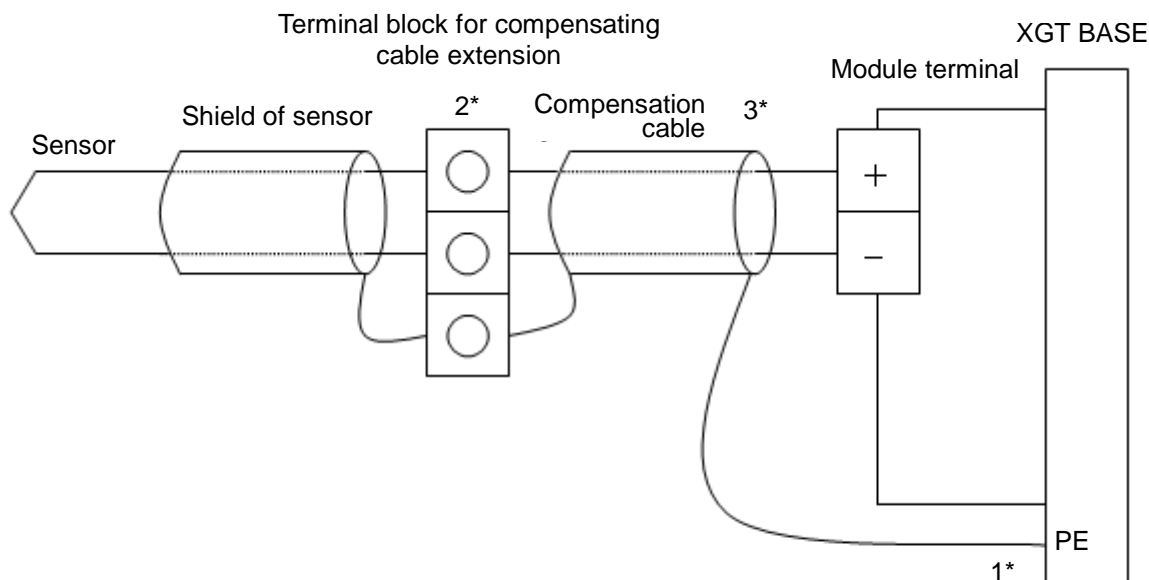

1. In case sensor and compensating cable are shielded, shield connection is possible to PLC PE terminal
2. It is necessary to use extension terminal block of which material is kept at uniform temperature in order to reduce error.
3. Compensating cable should use the same type of sensor, which was used for measuring.

#### Remark

Each channel of this module is isolated by transformer

## 3.2.3 No. of Terminal block

Channel	Terminal block
-	1
-	2
-	3
-	4
CH0 +	5
CH1 +	6
CH0 -	7
CH1 -	8
-	9
RJC	10
-	11
RJC	12
CH2 +	13
CH3 +	14
CH2 -	15
CH3 -	16
-	17
-	18

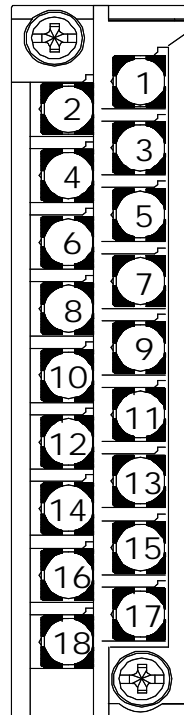





## Chapter 4 Operation Setting and Monitor

### 4.1 Operation Setting Procedure

Figure 4.1 shows the operation setting procedure.

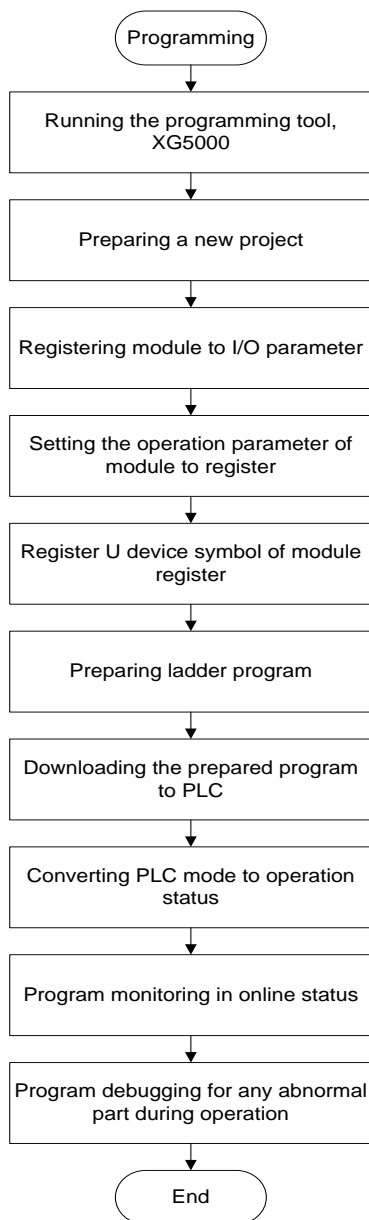

[Fig 4. 1] Operation Setting Procedure

### 4.2 Operation Parameter Setting

Operation parameters of TC module can be specified through [I/O parameters] of XG5000.

#### 4.2.1 Setting items

For the user's convenience, XG5000 provides GUI (Graphical User Interface) for parameters setting of TC module. Setting items available through [I/O parameters] of the XG5000 project window are described below in the table 4.1.

Item	Details
[I/O parameters]	<p>(1) Specify the following setting items necessary for the module operation.</p> <ul style="list-style-type: none"> <li>- Channel Run/Stop</li> <li>- Sensor type (K, J, E, T, B, R, S, N, C)</li> <li>- Temperature unit(°C/°F)</li> <li>- Filter constant</li> <li>- Average processing (sampling/time/frequency/movement)</li> <li>- Average value</li> <li>- Scaling data type</li> <li>- Scaling min. value</li> <li>- Scaling max. value</li> <li>- Process alarm H. H. Limit</li> <li>- Process alarm H. Limit</li> <li>- Process alarm L. Limit</li> <li>- Process alarm L. L. Limit</li> <li>- Process alarm HYS (hysteresis)</li> <li>- Type of gradient alarm (change value/change rate)</li> <li>- Gradient alarm higher value</li> <li>- Gradient alarm lower value</li> <li>- Gradient alarm period</li> </ul> <p>(2) The data specified by user through S/W package will be saved on TC module when [I/O Parameters] are downloaded. In other words, the point of time when [I/O Parameters] are saved on the module has nothing to do with PLC CPU's status RUN or STOP.</p>

### 4.2.2 How to use [I/O parameters]

- 1) Run XG5000 to create a project. (Refer to XG5000 programming manual for details on how to create the project)
- 2) Click [Project] -> [New Project]

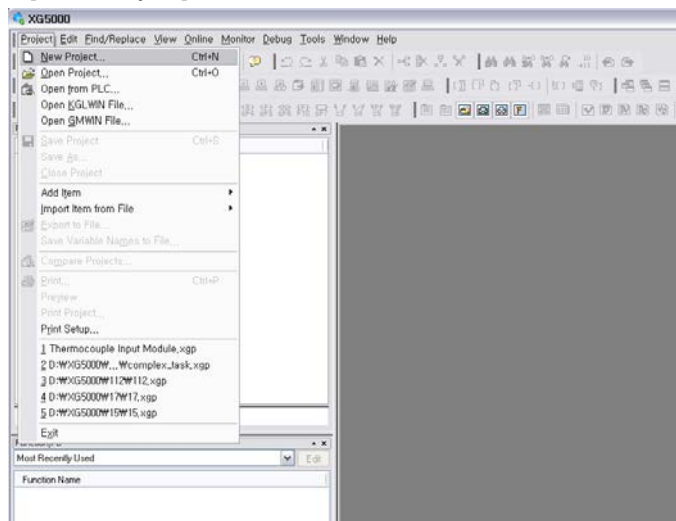

- 3) Type a program's name to create and click [OK]. At the moment, check the type of PLC used and set it.

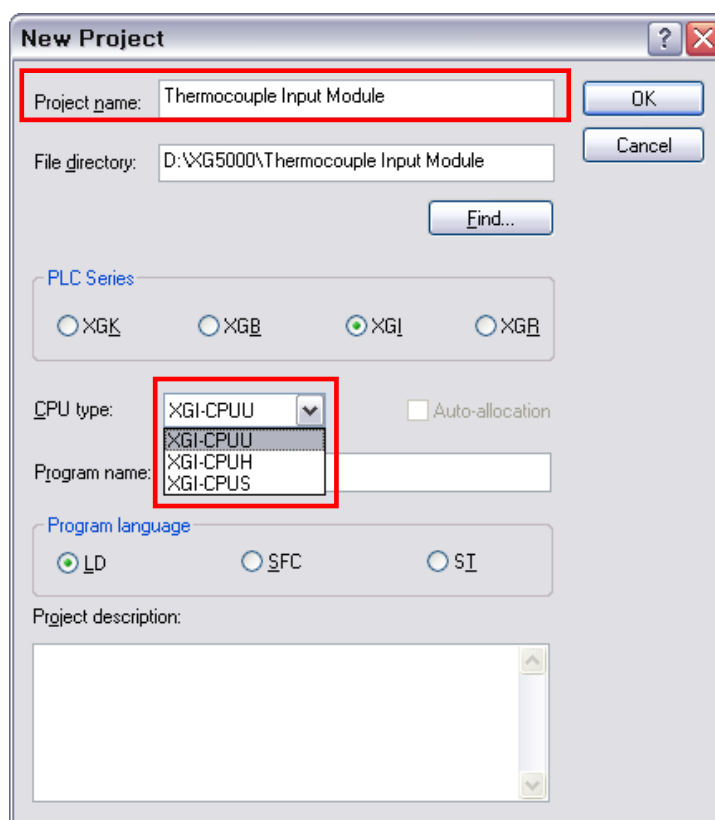

## Chapter 4 Operation Setting and Monitor

- 4) In the created project window, click [I/O Parameters] as follows.

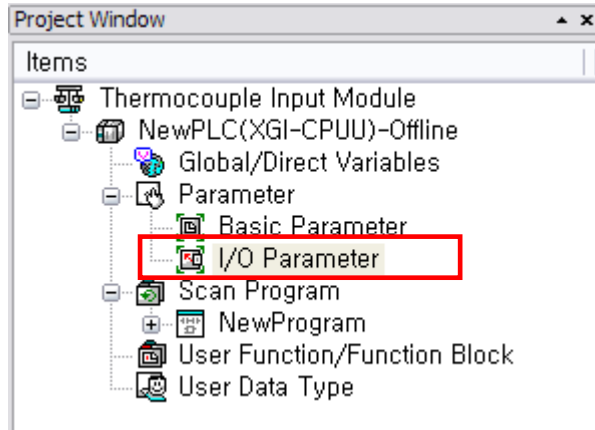

- 5) On the 'I/O parameters setting' screen, find and click the slot of the base where TC module is installed on. It is supposed that TC module is installed on Base No.0, Slot No.2 in this description.

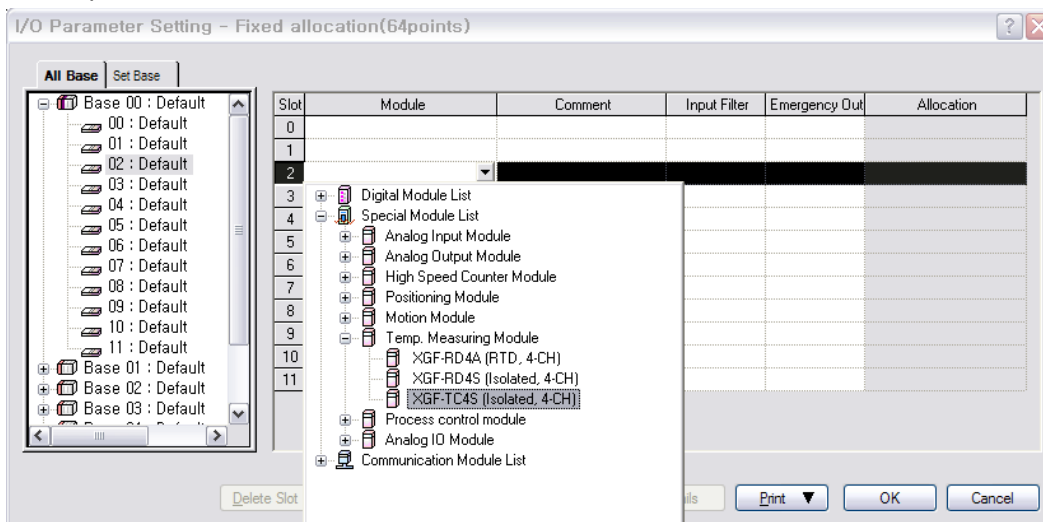

- 6) After the module selected, click [Details].

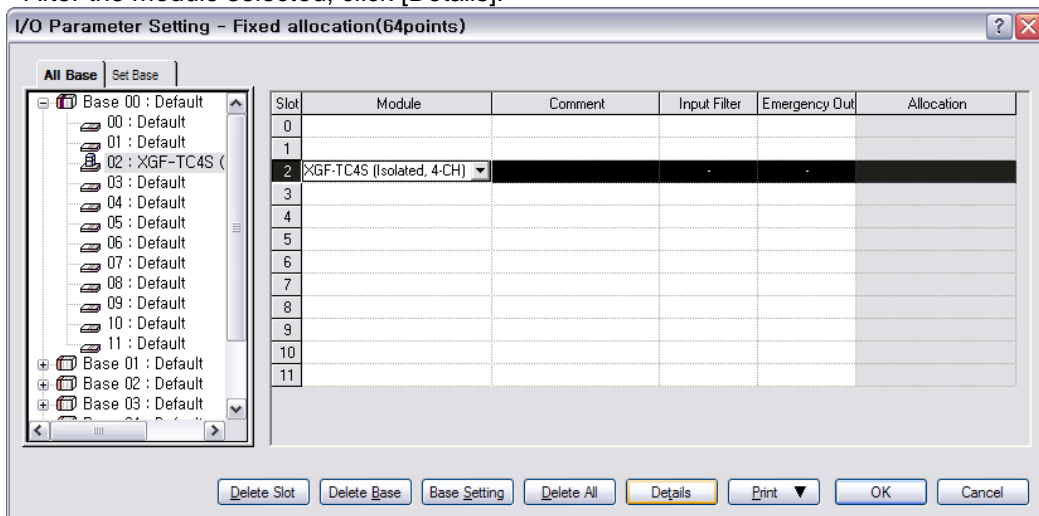

## Chapter 4 Operation Setting and Monitor

- 7) A screen will be displayed to specify parameters for respective channels as shown below. Click a desired item to display parameters to set for respective items.

XGF-TC4S (Isolated, 4-CH)

XGF-TC4S (Isolated, 4-CH)

Parameter	CH 0	CH 1	CH 2	CH 3
<input type="checkbox"/> Channel status	Disable	Disable	Disable	Disable
<input type="checkbox"/> Sensor status	K	K	K	K
<input type="checkbox"/> Temp. unit	Celsius	Celsius	Celsius	Celsius
Filter constant	0	0	0	0
<input type="checkbox"/> Average processing	Sampling	Sampling	Sampling	Sampling
Average value	0	0	0	0
<input type="checkbox"/> Scaling data type	Bipolar	Bipolar	Bipolar	Bipolar
Scaling min. value	-32768	-32768	-32768	-32768
Scaling max. value	32767	32767	32767	32767
Process alarm H.H.Limit	0	0	0	0
Process alarm H.Limit	0	0	0	0
Process alarm L.Limit	0	0	0	0
Process alarm L.L.Limit	0	0	0	0
Process alarm HYS	0	0	0	0
<input type="checkbox"/> RCA type	Change-Value	Change-Value	Change-Value	Change-Value
RCA high limit	0	0	0	0
RCA low limit	0	0	0	0
RCA period	40	40	40	40

OK Cancel

- (1) Channel status: Select Enable or Disable. Channel to operate is to be 'Enable'.

XGF-TC4S (Isolated, 4-CH)

XGF-TC4S (Isolated, 4-CH)

Parameter	CH 0	CH 1	CH 2	CH 3
<input type="checkbox"/> Channel status	Enable	Disable	Disable	Disable
<input type="checkbox"/> Sensor status	Disable	K	K	K
<input type="checkbox"/> Temp. unit	Enable	Celsius	Celsius	Celsius
Filter constant	0	0	0	0
<input type="checkbox"/> Average processing	Sampling	Sampling	Sampling	Sampling
Average value	0	0	0	0
<input type="checkbox"/> Scaling data type	Bipolar	Bipolar	Bipolar	Bipolar
Scaling min. value	-32768	-32768	-32768	-32768
Scaling max. value	32767	32767	32767	32767
Process alarm H.H.Limit	0	0	0	0
Process alarm H.Limit	0	0	0	0
Process alarm L.Limit	0	0	0	0
Process alarm L.L.Limit	0	0	0	0
Process alarm HYS	0	0	0	0
<input type="checkbox"/> RCA type	Change-Value	Change-Value	Change-Value	Change-Value
RCA high limit	0	0	0	0
RCA low limit	0	0	0	0
RCA period	40	40	40	40

OK Cancel

## Chapter 4 Operation Setting and Monitor

(2) Sensor type: Select a sensor type to use.

The screenshot shows the 'XGF-TC4S (Isolated, 4-CH)' configuration window. The 'Sensor status' dropdown menu is open, showing 'K' as the selected option. The table below shows the configuration for four channels (CH 0 to CH 3).

Parameter	CH 0	CH 1	CH 2	CH 3
<input type="checkbox"/> Channel status	Enable	Disable	Disable	Disable
<input type="checkbox"/> Sensor status	K	K	K	K
<input type="checkbox"/> Temp. unit	K	Celsius	Celsius	Celsius
Filter constant	0	0	0	0
<input type="checkbox"/> Average processing	J	Sampling	Sampling	Sampling
Average value	0	0	0	0
<input type="checkbox"/> Scaling data type	B	Bipolar	Bipolar	Bipolar
Scaling min. value	-32768	-32768	-32768	-32768
Scaling max. value	32767	32767	32767	32767
Process alarm H.H.Limit	0	0	0	0
Process alarm H.Limit	0	0	0	0
Process alarm L.Limit	0	0	0	0
Process alarm L.L.Limit	0	0	0	0
Process alarm HYS	0	0	0	0
<input type="checkbox"/> RCA type	Change-Value	Change-Value	Change-Value	Change-Value
RCA high limit	0	0	0	0
RCA low limit	0	0	0	0
RCA period	40	40	40	40

(3) Temperature unit: Select the output temperature unit among Celsius and Fahrenheit

The screenshot shows the 'XGF-TC4S (Isolated, 4-CH)' configuration window. The 'Temp. unit' dropdown menu is open, showing 'Celsius' as the selected option. The table below shows the configuration for four channels (CH 0 to CH 3).

Parameter	CH 0	CH 1	CH 2	CH 3
<input type="checkbox"/> Channel status	Enable	Disable	Disable	Disable
<input type="checkbox"/> Sensor status	K	K	K	K
<input type="checkbox"/> Temp. unit	Celsius	Celsius	Celsius	Celsius
Filter constant	0	0	0	0
<input type="checkbox"/> Average processing	F	Sampling	Sampling	Sampling
Average value	0	0	0	0
<input type="checkbox"/> Scaling data type	Bipolar	Bipolar	Bipolar	Bipolar
Scaling min. value	-32768	-32768	-32768	-32768
Scaling max. value	32767	32767	32767	32767
Process alarm H.H.Limit	0	0	0	0
Process alarm H.Limit	0	0	0	0
Process alarm L.Limit	0	0	0	0
Process alarm L.L.Limit	0	0	0	0
Process alarm HYS	0	0	0	0
<input type="checkbox"/> RCA type	Change-Value	Change-Value	Change-Value	Change-Value
RCA high limit	0	0	0	0
RCA low limit	0	0	0	0
RCA period	40	40	40	40

(4) Setting value input: If an input item is selected, the input range of the applicable setting value will be displayed at the bottom of the window.

The screenshot shows the 'XGF-TC4S (Isolated, 4-CH)' configuration window. The 'Temp. unit' dropdown menu is open, showing 'Celsius' as the selected option. The table below shows the configuration for four channels (CH 0 to CH 3). The input range '0, 160~64000' is displayed at the bottom of the window.

Parameter	CH 0	CH 1	CH 2	CH 3
<input type="checkbox"/> Channel status	Enable	Disable	Disable	Disable
<input type="checkbox"/> Sensor status	K	K	K	K
<input type="checkbox"/> Temp. unit	Celsius	Celsius	Celsius	Celsius
Filter constant	0	0	0	0
<input type="checkbox"/> Average processing	Sampling	Sampling	Sampling	Sampling
Average value	0	0	0	0
<input type="checkbox"/> Scaling data type	Bipolar	Bipolar	Bipolar	Bipolar
Scaling min. value	-32768	-32768	-32768	-32768
Scaling max. value	32767	32767	32767	32767
Process alarm H.H.Limit	0	0	0	0
Process alarm H.Limit	0	0	0	0
Process alarm L.Limit	0	0	0	0
Process alarm L.L.Limit	0	0	0	0
Process alarm HYS	0	0	0	0
<input type="checkbox"/> RCA type	Change-Value	Change-Value	Change-Value	Change-Value
RCA high limit	0	0	0	0
RCA low limit	0	0	0	0
RCA period	40	40	40	40

0, 160~64000

# Chapter 4 Operation Setting and Monitor

- (5) Incorrect setting: It displays a message if wrongly entered (if checking error information, it returns to the previous setting status. Then, please re-set the value).

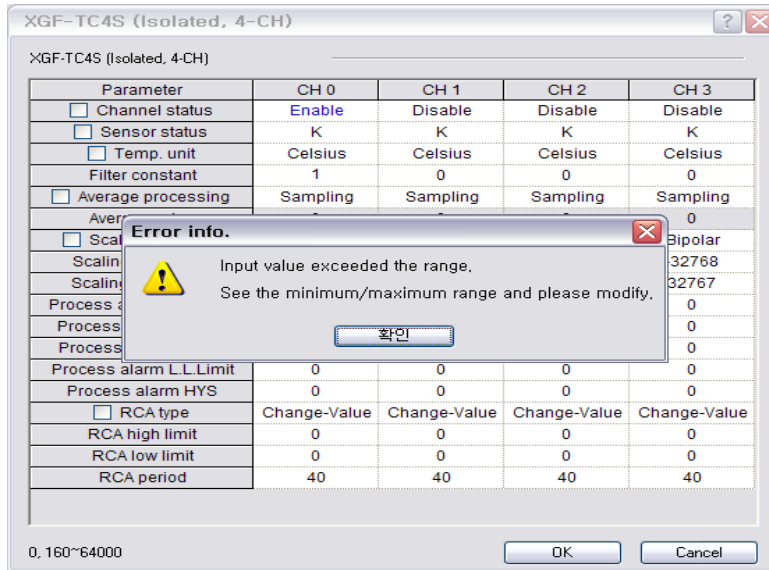

Note> If any incorrect number is entered, it shows the number in red as follows (in case of out-of-range value).

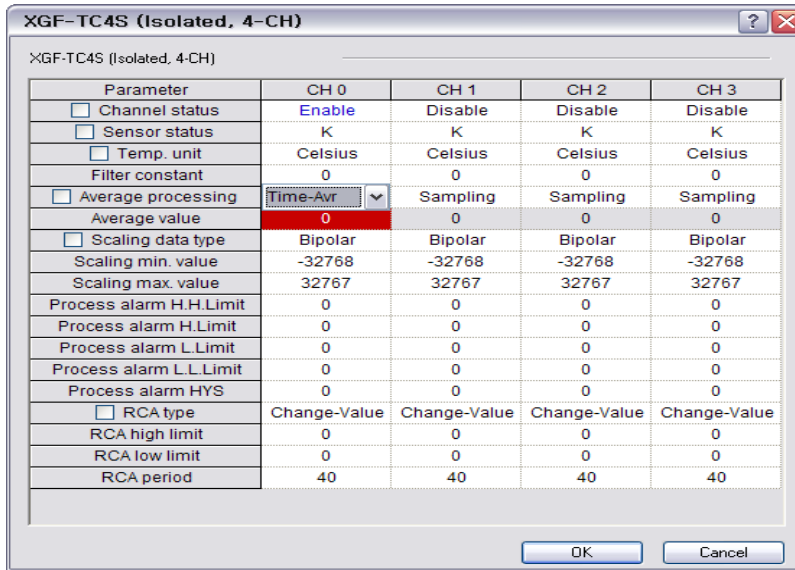



## Chapter 4 Operation Setting and Monitor

### 8) Applying identical settings to all channels

Check the check box on the parameter menu to select and change setting of a channel then the setting value of all the channels will be identical to changed setting value. Fig. 4.2 shows an example with this function that channel status is changed to 'Enable' of all the channels.

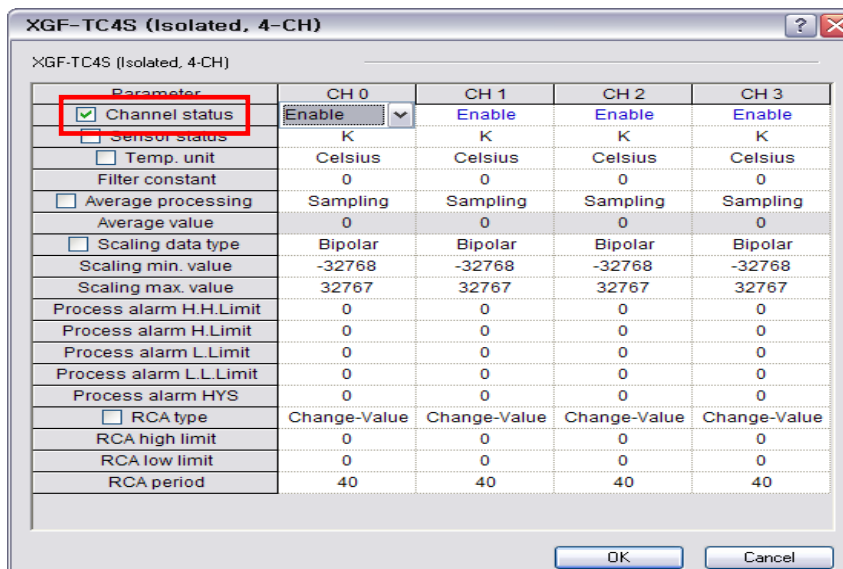

[Fig. 4. 2] Change of all the channel parameters

### 4.3 Functions of Special Module Monitoring

Functions of Special Module Monitoring are as described below in table 4.2.

[Table 4. 1] Functions of Special Module Monitoring

Item	Details	Remarks
[Special Module Monitoring]	<p>(1) Monitor/Test Through applicable XG5000 menu of [Monitor] -&gt; [Special Module Monitoring], temperature-converted value can be monitored and the operation of TC module can be tested.</p> <p>(2) Monitoring the max./min. value The max./min. value of the channel can be monitored during Run. However, the max./min. value displayed here is based on the present value shown on the screen. Accordingly, when [Monitoring/Test] screen is closed, the max./min. value will not be saved.</p>	

#### Notes

The screen may not be normally displayed due to insufficient system resource. In such a case, close the screen and finish other applications and restart XG5000.

### 4.4 Precautions

- The parameters specified to test TC module on the “Special Module Monitoring” screen will be deleted when “Special Module Monitoring” screen is closed. In other words, the parameters of TC module specified on the “Special Module Monitoring” screen will not be saved in [I/O parameters] located on the left tap of XG5000.

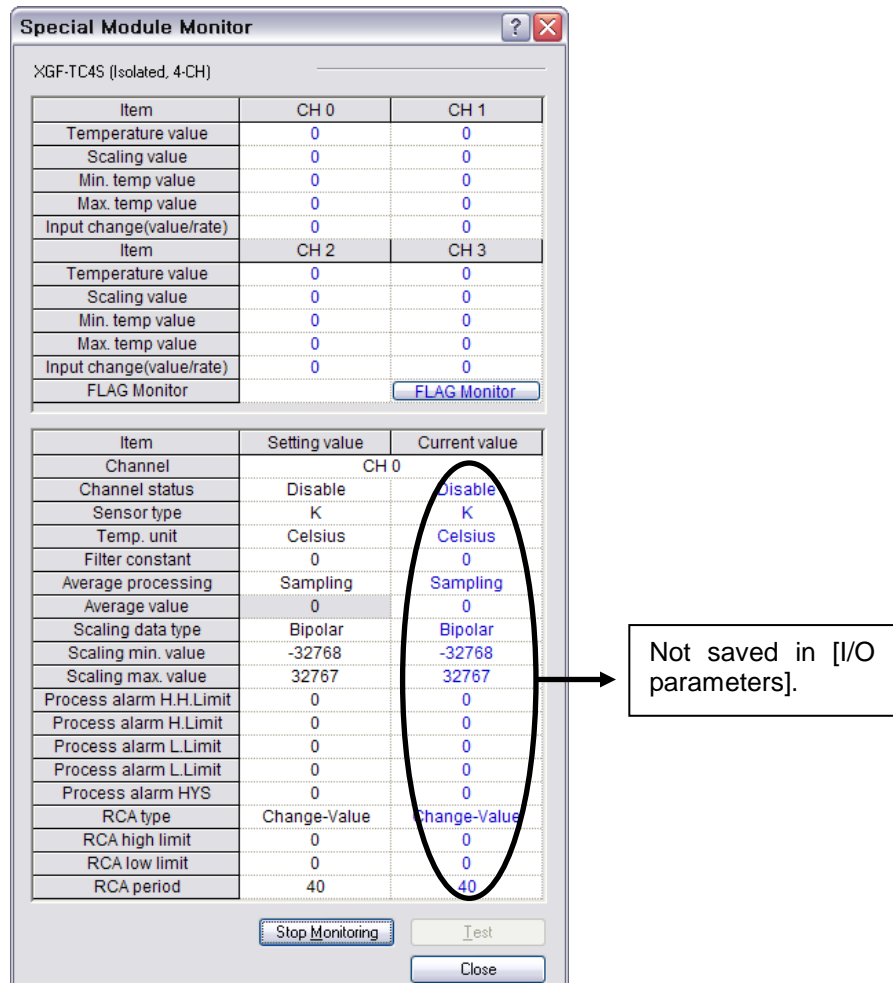

**Special Module Monitor**

XGF-TC4S (Isolated, 4-CH)

Item	CH 0	CH 1
Temperature value	0	0
Scaling value	0	0
Min. temp value	0	0
Max. temp value	0	0
Input change(value/rate)	0	0
Item	CH 2	CH 3
Temperature value	0	0
Scaling value	0	0
Min. temp value	0	0
Max. temp value	0	0
Input change(value/rate)	0	0

FLAG Monitor

Item	Setting value	Current value
Channel	CH 0	
Channel status	Disable	Disable
Sensor type	K	K
Temp. unit	Celsius	Celsius
Filter constant	0	0
Average processing	Sampling	Sampling
Average value	0	0
Scaling data type	Bipolar	Bipolar
Scaling min. value	-32768	-32768
Scaling max. value	32767	32767
Process alarm H.H.Limit	0	0
Process alarm H.Limit	0	0
Process alarm L.Limit	0	0
Process alarm L.Limit	0	0
Process alarm HYS	0	0
RCA type	Change-Value	Change-Value
RCA high limit	0	0
RCA low limit	0	0
RCA period	40	40

Stop Monitoring Test Close

Not saved in [I/O parameters].

- Test function of [Special Module Monitoring] operates with the sequence program stopped and not available during run.
- Test function of [Special Module Monitoring] is provided for user to check without sequence programming if the TC module operates normally. If TC module is to be used for other purposes than test, use parameters setting function in [I/O parameters].

## 4.5 Special Module Monitoring

How to use Special Module Monitoring will be described below.  
This is described based on XGF-TC4S.

### 4.5.1 Run [Special Module Monitoring]

Run Special Module Monitoring by selecting [On-Line] -> [Connect] and [Monitor] -> [Special Module Monitoring]. If the status is not [On-Line], [Special Module Monitoring] menu will not be activated.

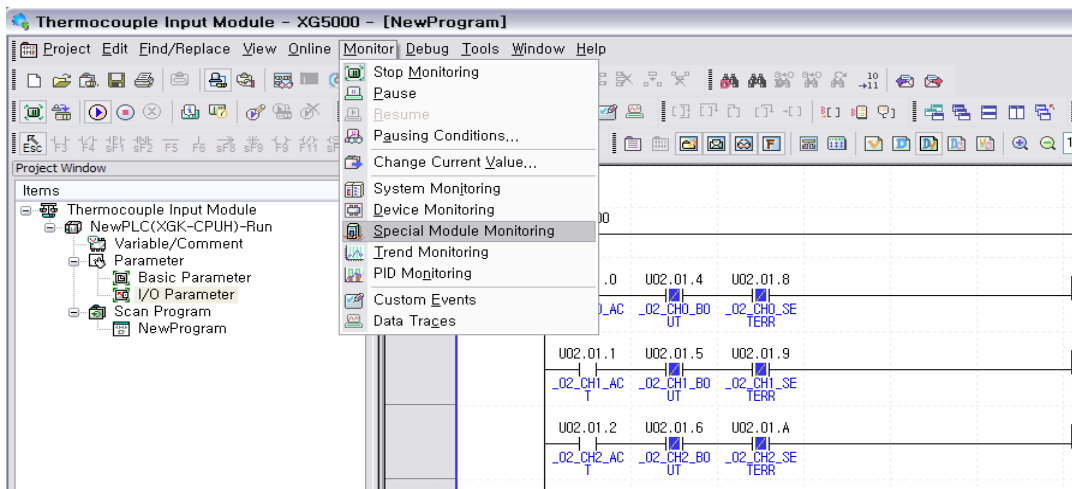

### 4.5.2 How to use [Special Module Monitoring]

- 1) With XG5000 connected to PLC CPU (on-line status), click [Monitor] -> [Special Module Monitoring] to display 'Special Module List' screen described in [Fig. 5.1] showing base/slot information in addition to special module type. The module installed on the present PLC system will be displayed on the list of dialog box.

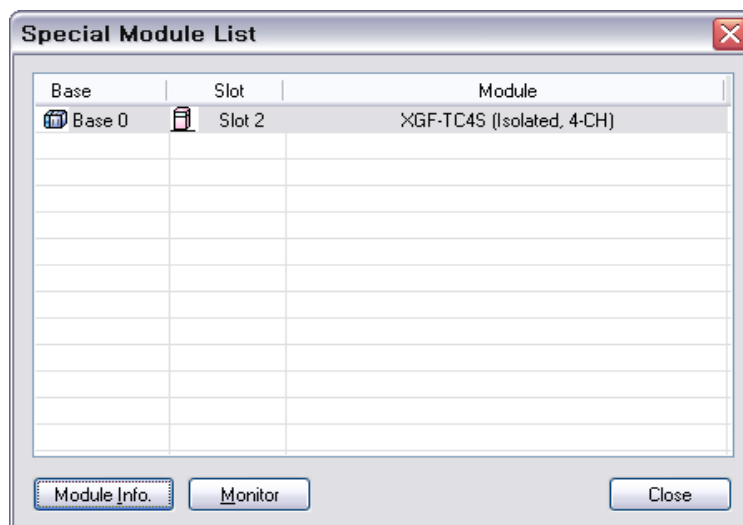

[Fig. 5. 1] Screen of [Special Module List]

- 2) Select Special Module in [Fig. 5.1] and click [Module Info.] to display the information as in [Fig. 5.2].

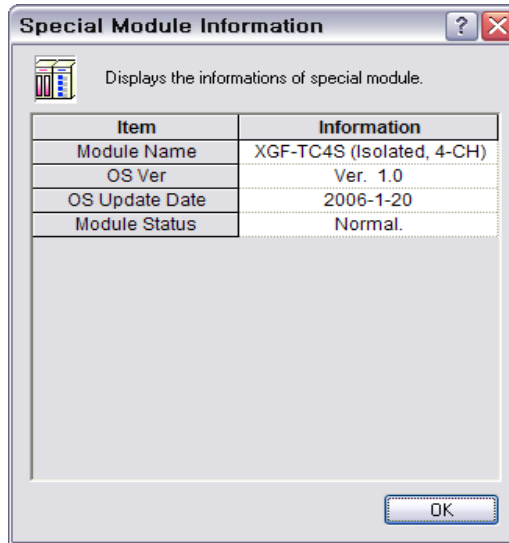

[Fig. 5. 2] Screen of [Module Information]

- 3) Click [Monitor] on the “Special Module List” screen in Fig. 5.1 to display [Special Module Monitor] screen as in Fig. 5.3, where 4 options are available such as [FLAG Monitor], [Start Monitoring], [Test] and [Close]. TC module’s temperature-converted value and scaling value are displayed on the monitor screen at the top of the screen, and parameters items of respective modules are displayed for individual setting on the test screen at the bottom of the screen.

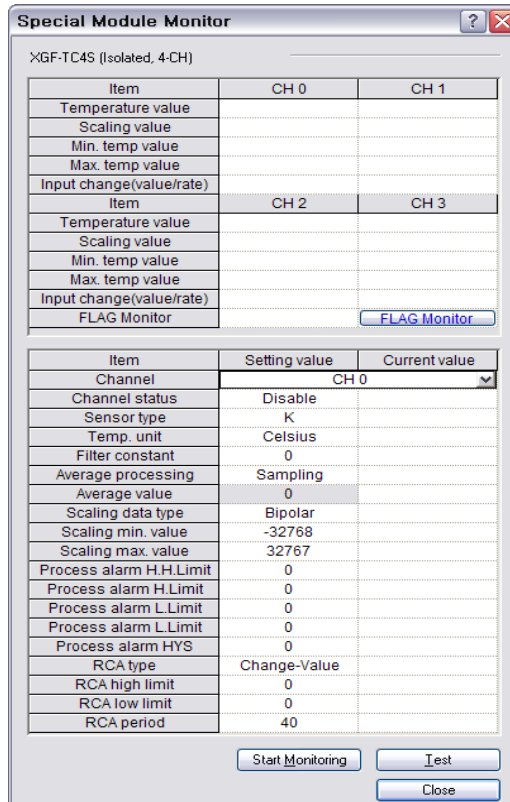

[Fig. 5. 3] Screen of [Special Module Monitoring]

- (1) [Start Monitoring]: Click [Start Monitoring] to display temperature-converted value of the presently operated channel. [Fig. 5.4] is the monitoring screen displayed when the whole channels are in Stop status. In the present value field at the screen bottom, presently specified parameters of TC module are displayed.

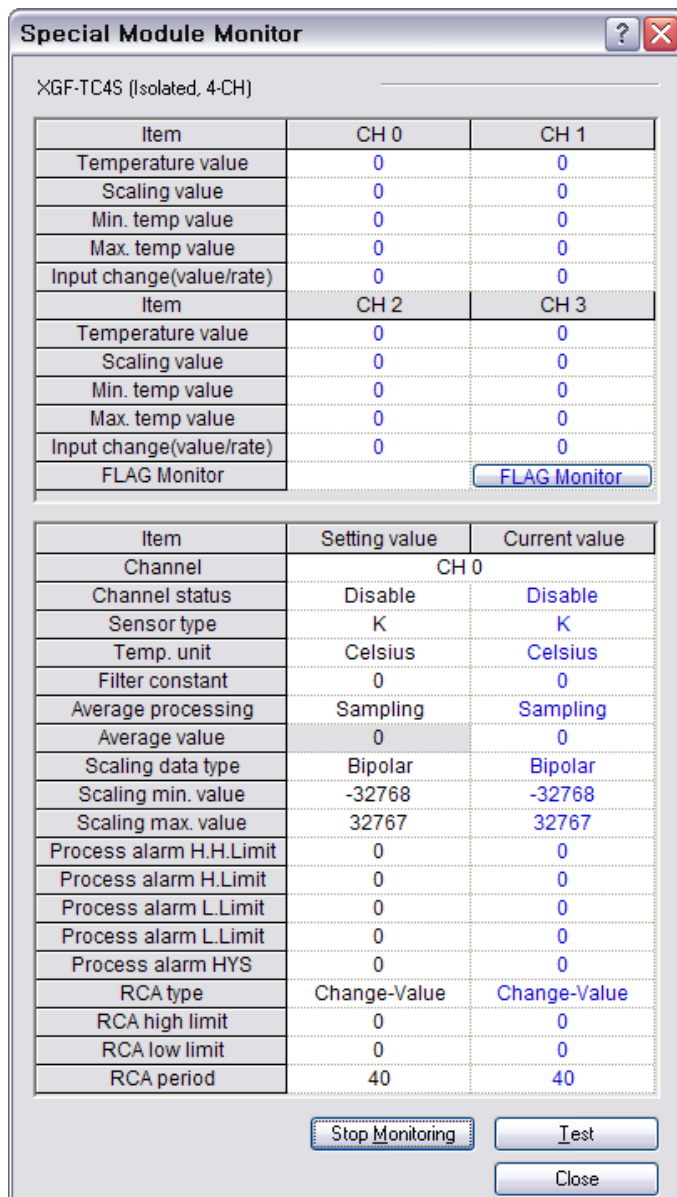

[Fig. 5. 4] Execution screen of [Start Monitoring]

## Chapter 4 Operation Setting and Monitor

- (2) [Test]: [Test] is used to change the presently specified parameters of TC module. Click the setting value at the bottom field of the screen to change parameters. [Fig. 5.5] will be displayed after [Test] is executed with channel 1's input sensor type changed to K in the state of input not wired.

**Special Module Monitor** XGF-TC4S (Isolated, 4-CH)

Item	CH 0	CH 1
Temperature value	13600	0
Scaling value	32767	0
Min. temp value	0	0
Max. temp value	0	0
Input change(value/rate)	0	0
Item	CH 2	CH 3
Temperature value	0	0
Scaling value	0	0
Min. temp value	0	0
Max. temp value	0	0
Input change(value/rate)	0	0
FLAG Monitor		<input type="button" value="FLAG Monitor"/>

Item	Setting value	Current value
Channel	CH 0	
Channel status	Enable	Enable
Sensor type	K	K
Temp. unit	Celsius	Celsius
Filter constant	0	0
Average processing	Sampling	Sampling
Average value	0	0
Scaling data type	Bipolar	Bipolar
Scaling min. value	-32768	-32768
Scaling max. value	32767	32767
Process alarm H.H.Limit	0	0
Process alarm H.Limit	0	0
Process alarm L.Limit	0	0
Process alarm L.Limit	0	0
Process alarm HYS	0	0
RCA type	Change-Value	Change-Value
RCA high limit	0	0
RCA low limit	0	0
RCA period	40	40

[Fig. 5.5] Execution screen of [Test]

- (3) [Max/Min active]: Click 'FLAG Monitor' on the upper screen to set [Max/Min active] of the TC module Enabled and close the command screen to monitor the max./min. temperature-converted value as shown below;

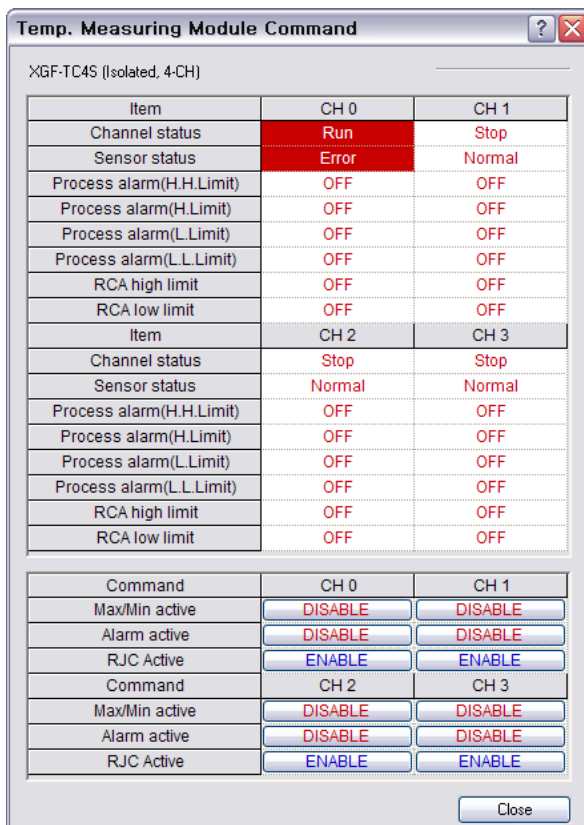

[Fig. 4. 6] Execution screen of [Search for max./min. value]

- (4) [Close]: [Close] is used to escape from the monitoring/test. When the monitoring/test screen is closed, the max. value, the min. value and the present value will not be saved any more.



## 4.6 Automatic Registration of U Device

Automatic registration function of XG5000 U device is described below.

### 4.6.1 Automatic registration of U device

See the special module information specified in [I/O parameters] to register the variable of each module automatically. User can modify the variables and descriptions.

[Sequence]

1) Specify the special module of the slot on [I/O parameters].

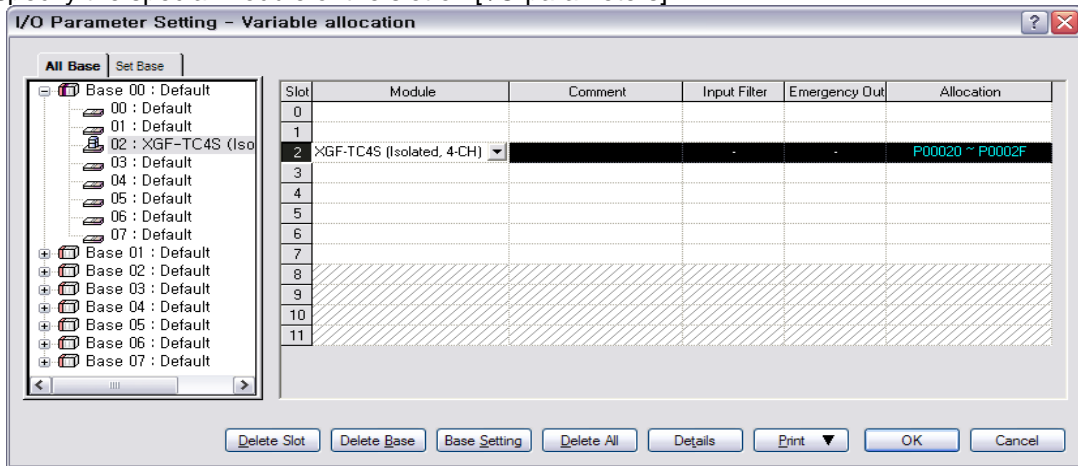

2) Click [OK].

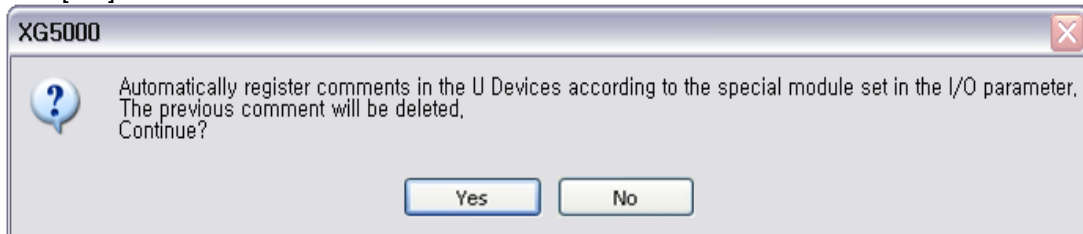

3) Click [Yes].

Variables will be registered as shown below on the screen.

	Variable	Type	Device	Used	Comment
1	_02_CH0_ADJERR	BIT	U02.00.0	<input type="checkbox"/>	Isolated Temp. Measuring Module : CH0 Offset/Gain Error
2	_02_CH1_ADJERR	BIT	U02.00.1	<input type="checkbox"/>	Isolated Temp. Measuring Module : CH1 Offset/Gain Error
3	_02_CH2_ADJERR	BIT	U02.00.2	<input type="checkbox"/>	Isolated Temp. Measuring Module : CH2 Offset/Gain Error
4	_02_CH3_ADJERR	BIT	U02.00.3	<input type="checkbox"/>	Isolated Temp. Measuring Module : CH3 Offset/Gain Error
5	_02_EEPROMERR	BIT	U02.00.D	<input type="checkbox"/>	Isolated Temp. Measuring Module : Offset/Gain Backup Error
6	_02_WDT_ERR	BIT	U02.00.E	<input type="checkbox"/>	Isolated Temp. Measuring Module : Module H/W Error
7	_02_RDV	BIT	U02.00.F	<input type="checkbox"/>	Isolated Temp. Measuring Module : Module Ready
8	_02_CH0_ACT	BIT	U02.01.0	<input type="checkbox"/>	Isolated Temp. Measuring Module : CH0 Running
9	_02_CH1_ACT	BIT	U02.01.1	<input type="checkbox"/>	Isolated Temp. Measuring Module : CH1 Running
10	_02_CH2_ACT	BIT	U02.01.2	<input type="checkbox"/>	Isolated Temp. Measuring Module : CH2 Running
11	_02_CH3_ACT	BIT	U02.01.3	<input type="checkbox"/>	Isolated Temp. Measuring Module : CH3 Running
12	_02_CH0_BOUT	BIT	U02.01.4	<input type="checkbox"/>	Isolated Temp. Measuring Module : CH0 Input Disconnection
13	_02_CH1_BOUT	BIT	U02.01.5	<input type="checkbox"/>	Isolated Temp. Measuring Module : CH1 Input Disconnection
14	_02_CH2_BOUT	BIT	U02.01.6	<input type="checkbox"/>	Isolated Temp. Measuring Module : CH2 Input Disconnection
15	_02_CH3_BOUT	BIT	U02.01.7	<input type="checkbox"/>	Isolated Temp. Measuring Module : CH3 Input Disconnection
16	_02_CH0_SETERR	BIT	U02.01.8	<input type="checkbox"/>	Isolated Temp. Measuring Module : CH0 Setting Error

## 4.6.2 Save variables

- 1) Contents in the 'View variables' tap can be saved in a text file.
- 2) Click 'Save in a text file' on the 'Edit' menu.
- 3) Contents in the 'View variables' tap will be saved in a text file..

## 4.6.3 View variables in the program

- 1) Example program of XG5000 is as shown below;

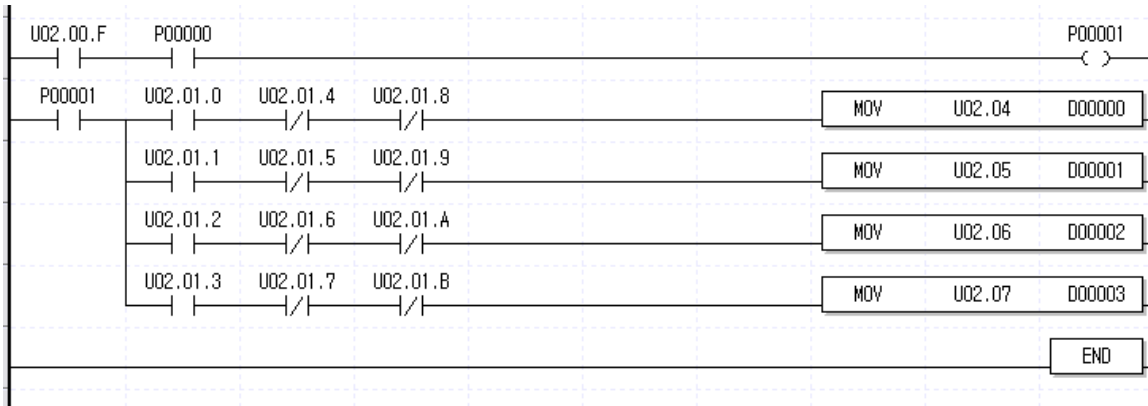

- 2) Click 'View variables' on the tap menu of 'View'. Devices will be changed to variables.

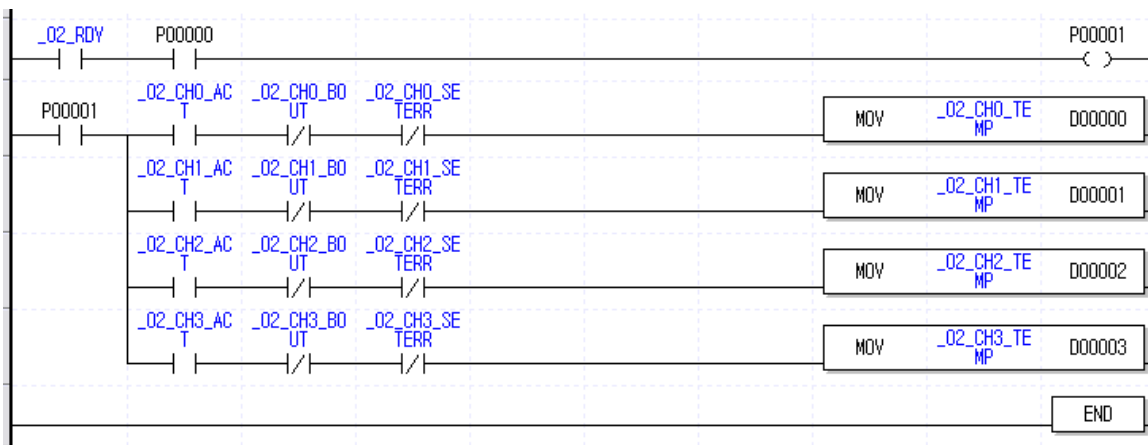

## Chapter 4 Operation Setting and Monitor

3) Click 'Devices/Variables' on the menu of 'View' to see devices and variables at a time.

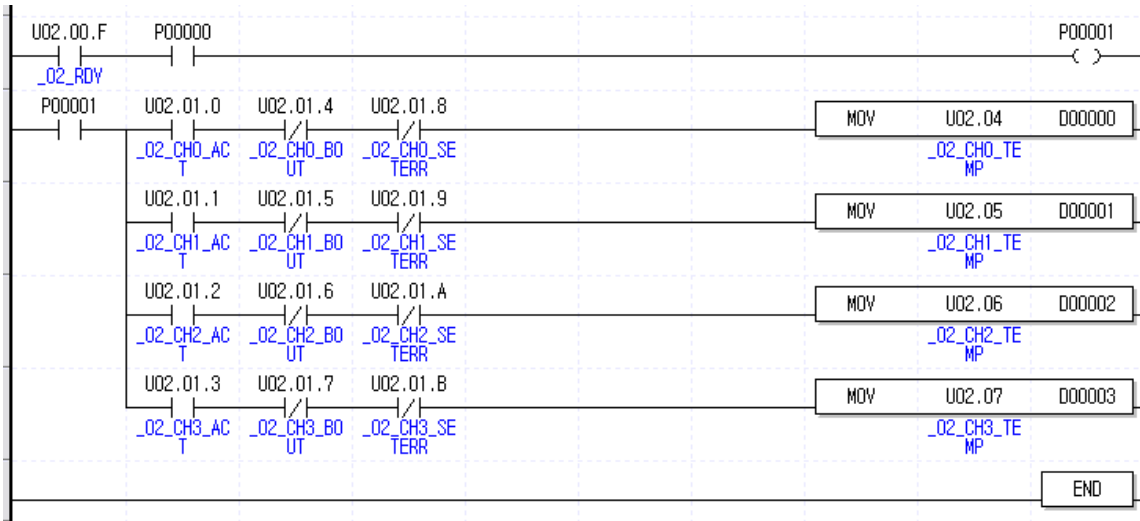

4) Click 'Devices/Comments' on the menu of 'View' to see devices and descriptions at a time.

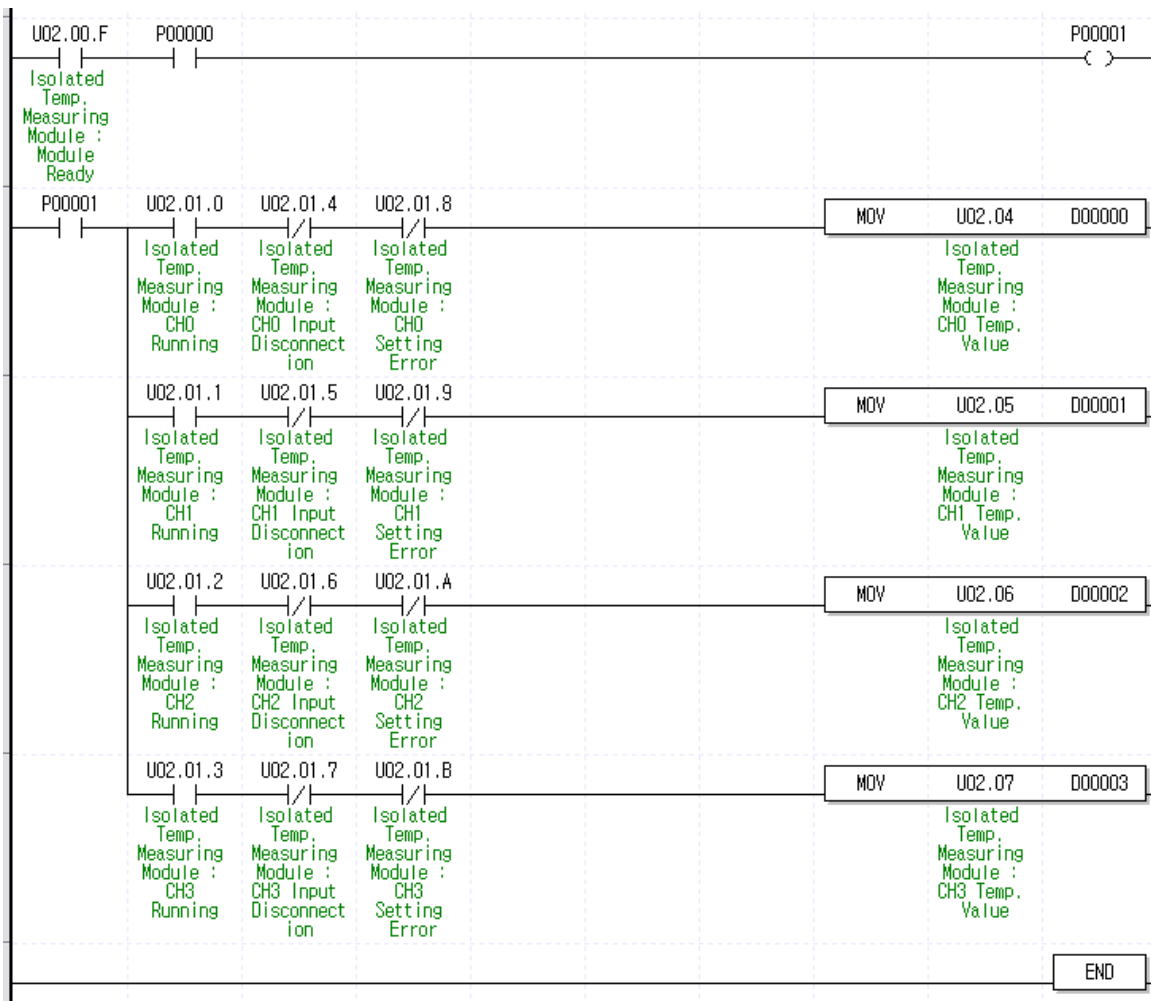

## Chapter 5 Configuration and Function of Internal Memory (For XGK)

XGF-TC4S module has internal memory to send and receive data from/to XGT PLC.

### 5.1 Configuration of Internal Memory

It describes the configuration of internal memory.

#### 5.1.1 I/O Data of thermocouple I/O module

Temperature conversion data I/O area is displayed at table 5.1

**[Table 5. 1] Conversion data I/O area**

Device assignment	Description	R/W	Signal direction
UXY.00.0	CH 0 offset/gain adjustment error	R	TC → CPU
UXY.00.1	CH 1 offset/gain adjustment error	R	
UXY.00.2	CH 2 offset/gain adjustment error	R	
UXY.00.3	CH 3 offset/gain adjustment error	R	
UXY.00.D	Module offset/gain backup error	R	
UXY.00.E	Module H/W error	R	
UXY.00.F	Module Ready	R	
UXY.01.0	CH 0 operating	R	TC → CPU
UXY.01.1	CH 1 operating	R	
UXY.01.2	CH 2 operating	R	
UXY.01.3	CH 3 operating	R	
UXY.01.4	CH 0 disconnection	R	
UXY.01.5	CH 1 disconnection	R	
UXY.01.6	CH 2 disconnection	R	
UXY.01.7	CH 3 disconnection	R	
UXY.01.8	CH 0 setting error	R	
UXY.01.9	CH 1 setting error	R	
UXY.01.A	CH 2 setting error	R	
UXY.01.B	CH 3 setting error	R	
UXY.02.0	CH 0 process alarm L.L.	R	TC → CPU
UXY.02.1	CH 0 process alarm L.	R	
UXY.02.2	CH 0 process alarm H.	R	
UXY.02.3	CH 0 process alarm H.H.	R	
UXY.02.4	CH 1 process alarm L.L.	R	
UXY.02.5	CH 1 process alarm L.	R	
UXY.02.6	CH 1 process alarm H.	R	
UXY.02.7	CH 1 process alarm H.H.	R	

## Chapter 5 Configuration and Function of Internal Memory (For XGK)

Device assignment	Description	R/W	Signal direction
UXY.02.8	CH 2 process alarm L.L.	R	TC → CPU
UXY.02.9	CH 2 process alarm L.	R	
UXY.02.A	CH 2 process alarm H.	R	
UXY.02.B	CH 2 process alarm H.H.	R	
UXY.02.C	CH 3 process alarm L.L.	R	
UXY.02.D	CH 3 process alarm L.	R	
UXY.02.E	CH 3 process alarm H.	R	
UXY.02.F	CH 3 process alarm H.H.	R	
UXY.03.0	CH 0 gradient alarm L.	R	TC → CPU
UXY.03.1	CH 0 gradient alarm H.	R	
UXY.03.4	CH 1 gradient alarm L.	R	
UXY.03.5	CH 1 gradient alarm H.	R	
UXY.03.8	CH 2 gradient alarm L.	R	
UXY.03.9	CH 2 gradient alarm H.	R	
UXY.03.C	CH 3 gradient alarm L.	R	
UXY.03.D	CH 3 gradient alarm H.	R	
UXY.04	CH 0 temperature conversion value	R	TC → CPU
UXY.05	CH 1 temperature conversion value	R	
UXY.06	CH 2 temperature conversion value	R	
UXY.07	CH 3 temperature conversion value	R	
UXY.08	CH 0 scaling operation value	R	
UXY.09	CH 1 scaling operation value	R	
UXY.10	CH 2 scaling operation value	R	
UXY.11	CH 3 scaling operation value	R	
UXY.12	CH 0 min. temperature conversion value	R	
UXY.13	CH 0 max. temperature conversion value	R	
UXY.14	CH 1 min. temperature conversion value	R	
UXY.15	CH 1 max. temperature conversion value	R	
UXY.16	CH 2 min. temperature conversion value	R	
UXY.17	CH 2 max. temperature conversion value	R	
UXY.18	CH 3 min. temperature conversion value	R	
UXY.19	CH 3 max. temperature conversion value	R	
UXY.20	CH 0 data upload time	R	
UXY.21		R	
UXY.22	CH 1 data upload time	R	
UXY.23		R	

## Chapter 5 Configuration and Function of Internal Memory (For XGK)

Device	Description	R/W	Signal direction
UXY.24	CH 2 data upload time	R	TC → CPU
UXY.25		R	
UXY.26	CH 3 data upload time	R	
UXY.27		R	

(2) Command sent from XGT PLC to module (XGT PLC output area)

Device	Description	R/W	Signal direction
UXY.29.0	CH 0 max./min. searching Enable/Disable	R/W	CPU → TC
UXY.29.1	CH 1 max./min. searching Enable/Disable	R/W	
UXY.29.2	CH 2 max./min. searching Enable/Disable	R/W	
UXY.29.3	CH 3 max./min. searching Enable/Disable	R/W	
UXY.29.4	CH 0 alarm (process alarm/gradient alarm) Enable/Disable	R/W	CPU → TC
UXY.29.5	CH 1 alarm (process alarm/gradient alarm) Enable/Disable	R/W	
UXY.29.6	CH 2 alarm (process alarm/gradient alarm) Enable/Disable	R/W	
UXY.29.7	CH 3 alarm (process alarm/gradient alarm) Enable/Disable	R/W	
UXY.29.8	CH 0 cold junction compensating function Disable/Enable	R/W	CPU → TC
UXY.29.9	CH 1 cold junction compensating function Disable/Enable	R/W	
UXY.29.A	CH 2 cold junction compensating function Disable/Enable	R/W	
UXY.29.B	CH 3 cold junction compensating function Disable/Enable	R/W	

- 1) X and Y in the above table means the number of base and slot on which module is built respectively.
- 2) In case reading or writing 'CH0 temp conversion value' of a module installed on #0 base and #4 slot, it is expressed as U04.04.

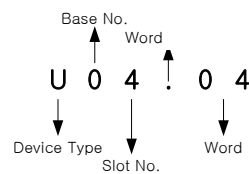

- 3) In case reading 'CH3 disconnection detection flag' of a module installed on #0 base and #5 slot, it is expressed as U05.01.7.

(In case module is installed on #10 slot, it is expressed as U0A.01.7.)

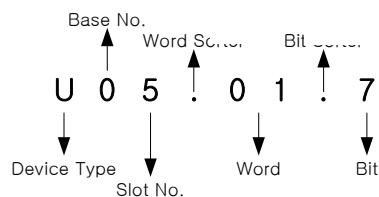

**5.1.2 Operation parameter setting area (use of PUT/PUTP)**

Memory address		Description	R/W	Remarks
Dec.	Hex.			
0	0H	Designate a channel to use	R/W	
1	1H	Set sensor type of CH 0	R/W	
2	2H	Set sensor type of CH 1		
3	3H	Set sensor type of CH 2		
4	4H	Set sensor type of CH 3		
5	5H	Designate temperature metric system	R/W	
6	6H	Set CH 0 filter value	R/W	
7	7H	Set CH 1 filter value		
8	8H	Set CH 2 filter value		
9	9H	Set CH 3 filter value		
10	AH	Set averaging method of CH 0	R/W	
11	BH	Set averaging method of CH 1		
12	CH	Set averaging method of CH 2		
13	DH	Set averaging method of CH 3		
14	EH	Set mean value of CH 0	R/W	
15	FH	Set mean value of CH 1		
16	10H	Set mean value of CH 2		
17	11H	Set mean value of CH 3		
18	12H	Designate scaling type	R/W	
19	13H	Set min. value of CH 0 scaling range	R/W	
20	14H	Set max. value of CH 0 scaling range		
21	15H	Set min. value of CH 1 scaling range		
22	16H	Set max. value of CH 1 scaling range		
23	17H	Set min. value of CH 2 scaling range		
24	18H	Set max. value of CH 2 scaling range		
25	19H	Set min. value of CH 3 scaling range		
26	1AH	Set max. value of CH 3 scaling range		
27	1BH	Set H.H. value of CH 0 process alarm	R/W	
28	1CH	Set H. value of CH 0 process alarm		
29	1DH	Set L. value of CH 0 process alarm		
30	1EH	Set L.L. value of CH 0 process alarm		
31	1FH	Set H.H. value of CH 1 process alarm		
32	20H	Set H. value of CH 1 process alarm		
33	21H	Set L. value of CH 1 process alarm		
34	22H	Set L.L. value of CH 1 process alarm		

## Chapter 5 Configuration and Function of Internal Memory (For XGK)

Memory address		Description	R/W	Remarks
Dec.	Hex.			
35	23H	Set H.H. value of CH 2 process alarm	R/W	
36	24H	Set H. value of CH 2 process alarm		
37	25H	Set L. value of CH 2 process alarm		
38	26H	Set L.L. value of CH 2 process alarm		
39	27H	Set H.H. value of CH 3 process alarm		
40	28H	Set H. value of CH 3 process alarm		
41	29H	Set L. value of CH 3 process alarm		
42	2AH	Set L.L. value of CH 3 process alarm		
43	2BH	Set Hysteresis of CH 0 process alarm	R/W	
44	2CH	Set Hysteresis of CH 1 process alarm		
45	2DH	Set Hysteresis of CH 2 process alarm		
46	2EH	Set Hysteresis of CH 3 process alarm		
47	2FH	Select alarm type of gradient alarm	R/W	
48	30H	Set H. value of CH 0 gradient alarm	R/W	
49	31H	Set L. value of CH 0 gradient alarm		
50	32H	Set H. value of CH 1 gradient alarm		
51	33H	Set L. value of CH 1 gradient alarm		
52	34H	Set H. value of CH 2 gradient alarm		
53	35H	Set L. value of CH 2 gradient alarm		
54	36H	Set H. value of CH 3 gradient alarm		
55	37H	Set L. value of CH 3 gradient alarm		
56	38H	Set detection interval of CH 0 gradient alarm	R/W	
57	39H	Set detection interval of CH 1 gradient alarm		
58	3AH	Set detection interval of CH 2 gradient alarm		
59	3BH	Set detection interval of CH 3 gradient alarm		



**5.1.3 Other data monitoring area (use of GET/GETP)**

Memory address		Description	R/W	Remarks
Dec.	Hex.			
60	3CH	CH 0 setting error info(flag)	R	
61	3DH	CH 1 setting error info(flag)		
62	3EH	CH 2 setting error info(flag)		
63	3FH	CH 3 setting error info(flag)		
64	40H	CH 0 input change (input change alarm function data)	R	
65	41H	CH 1 input change (input change alarm function data)		
66	42H	CH 2 input change (input change alarm function data)		
67	43H	CH 3 input change (input change alarm function data)		
68	44H	CH 0 disconnection info(code)	R	
69	45H	CH 1 disconnection info(code)		
70	46H	CH 2 disconnection info(code)		
71	47H	CH 3 disconnection info(code)		
72	48H	CH 0 cold junction compensating temp. (RJC temperature)	R	
73	49H	CH 1 cold junction compensating temp. (RJC temperature)		
74	4AH	CH 2 cold junction compensating temp. (RJC temperature)		
75	4BH	CH 3 cold junction compensating temp. (RJC temperature)		

**Remark**

U device: the data such as conversion data of special module is assigned at this device. Like other devices, you can use this device for instruction directly such as MOV, CMP, ADD. (to read/write parameter area of module, PUT/GET should be used)

**5.2 Function of Internal memory**

**5.2.1 Module status flag (UXY.00, X: base number, Y: slot number)**

- 1) **UXY.00.3~0**: Indicate abnormal offset/gain adjustment of a channel; it shows 1 if offset value > gain value or disconnection in adjusting.  
If it shows 1, refer to “Chapter 9 Troubleshooting”.
- 2) **UXY.00.D**: Indicate abnormal module offset/gain memory  
If it shows 1, refer to “Chapter 9 Troubleshooting”.
- 3) **UXY.00.E**: Indicate abnormal module H/W; If it shows 1, refer to “Chapter 9 Troubleshooting”.
- 4) **UXY.00.F**: It is on and processes temperature conversion when PLC CPU is powered on or when conversion of thermocouple input is ready.

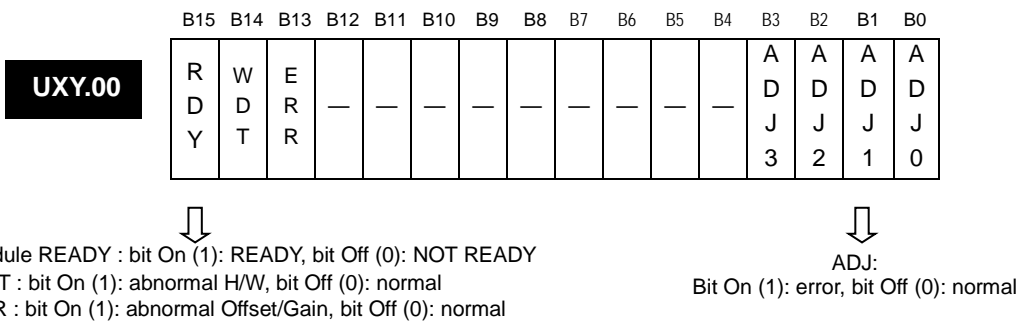

**5.2.2 Channel status flag (UXY.00, X: base number, Y: slot number)**

- 1) **UXY.01.3~0**: Indicates operation status of a channel; It shows 1 if the channel bit of channel designation area (0 address) is set as 1.
- 2) **UXY.01.4~7**: If disconnection of a channel shows 1, refer to “setting error info area (68~71 address).”
- 3) **UXY.01.B~8**: If setting error of a channel is 1, refer to “setting error info area (60~63 address).”  
<Note> Bit info in the area is cleared if a channel stops.

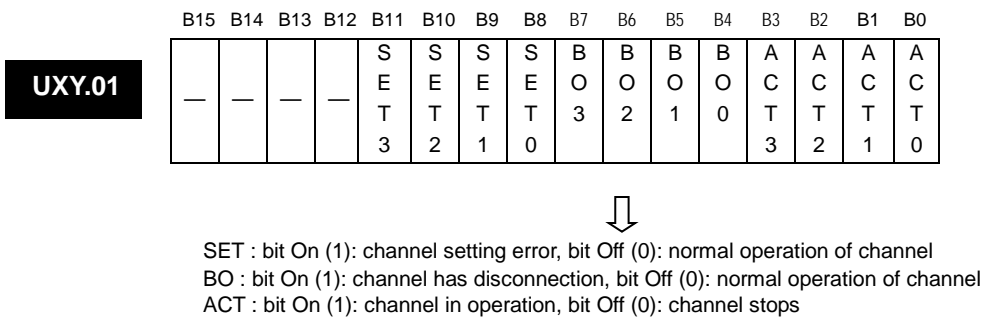

**5.2.3 Process alarm output flag (UXY.00, X: base number, Y: slot number)**

- 1) UXY.02.3~0:CH 0 process output flag indicating H.H/H/L/L.L alarms.
- 2) UXY.02.4~7:CH 1 process output flag indicating H.H/H/L/L.L alarms.
- 3) UXY.02.8~B:CH 2 process output flag indicating H.H/H/L/L.L alarms.
- 4) UXY.02.C~F: CH 3 process output flag indicating H.H/H/L/L.L alarms.

<Note> Bit info in the area is cleared if a channel stops.

UXY.02		B15	B14	B13	B12	B11	B10	B9	B8	B7	B6	B5	B4	B3	B2	B1	B0
		P	P	P	P	P	P	P	P	P	P	P	P	P	P	P	P
A	A	A	A	A	A	A	A	A	A	A	A	A	A	A	A	A	A
H	H	L	L	H	H	L	L	L	L	H	H	L	L	H	H	L	L
H	3	3	L	H	2	2	L	L	H	1	1	L	L	H	0	0	L
3			3	2			2	2	1			1	0			0	0



PA : bit On (1): channel alarm On , bit Off (0): channel alarm Off

**5.2.4 Rate - change alarm output flag**

- 1) UXY.03.1~0: indicate H/L of CH 0 rate-change-alarm output flag.
- 2) UXY.03.5~4: indicate H/L of CH 1 rate-change-alarm output flag.
- 3) UXY.03.9~8: indicate H/L of CH 2 rate-change-alarm output flag.
- 4) UXY.03.D~C: indicate H/L of CH 3 rate-change-alarm output flag.

UXY.03		B15	B14	B13	B12	B11	B10	B9	B8	B7	B6	B5	B4	B3	B2	B1	B0
				R	R			R	R					R	R		
		C	C			C	C					C	C			C	C
		A	A			A	A					A	A			A	A
		H	L			H	L					H	L			H	L
		3	3			2	2					1	1			0	0



PA : bit On (1): channel alarm On , bit Off (0): channel alarm Off

### 5.2.5 Channel temperature conversion value

- 1) Output to temperature conversion value buffer memory address 4 ~ 7(UXY.04 ~ UXY.07) by channels.
- 2) Temperature conversion value is saved as 16 bits binary numeral.

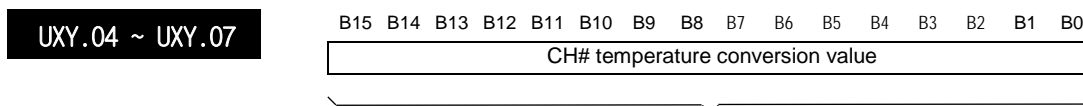

Address	Description
Address 4	Temperature conversion value of CH 0
Address 5	Temperature conversion value of CH 1
Address 6	Temperature conversion value of CH 2
Address 7	Temperature conversion value of CH 3

It outputs temperature conversion value within the below range depending on sensor type

	Celsius(℃)	Fahrenheit[°F]
K	-2600 ~ 13600	-4360 ~ 24800
J	-2100 ~ 12100	-3460 ~ 22100
E	-2600 ~ 10100	-4360 ~ 18500
T	-2600 ~ 4100	-4360 ~ 7700
B	3900 ~ 18100	7340 ~ 32900
R	- 600 ~ 17600	- 760 ~ 32000
S	- 600 ~ 17600	- 760 ~ 32000
N	-2800 ~ 13100	-4720 ~ 23900
C	- 100 ~ 23100	140 ~ 41900

### 5.2.6 Channel scale operation value

- 1) It outputs scale operation value for temperature conversion value to Address 8 ~11 (UXY.08 ~ UXY.11) by channels (for more information about function, refer to “Chapter 2 Specifications”).
- 2) Scale operation value can be temporarily set as 16 bits data, -32768 ~ 32767 or 0 ~ 65535.

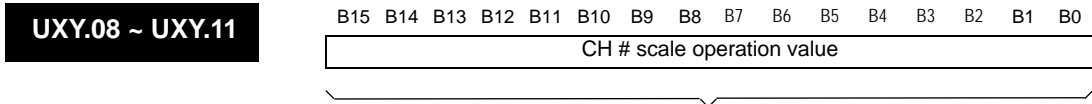

Address	Description
Address 8	CH 0 scale operation value
Address 9	CH 1 scale operation value
Address 10	CH 2 scale operation value
Address 11	CH 3 scale operation value

- 3) This area is cleared if a channel stops (output 0 if stoppage).

### 5.2.7 Min./Max. channel temperature conversion value

- 1) As long as max./minx searching function is allowed, the max./min temperature is displayed. (For more information about function, refer to “Chapter 2 Specifications.”)

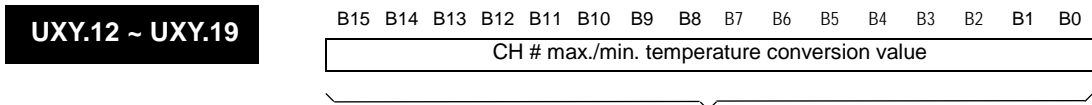

Address	Description
Address 12	CH 0 min. temperature conversion value
Address 13	CH 0 max. temperature conversion value
Address 14	CH 1 min. temperature conversion value
Address 15	CH 1 max. temperature conversion value
Address 16	CH 2 min. temperature conversion value
Address 17	CH 2 max. temperature conversion value
Address 18	CH 3 min. temperature conversion value
Address 19	CH 4 max. temperature conversion value

- 2) The area is cleared if a channel stops (output 0 if stoppage).

## 5.2.8 Data upload time

- 1) It is the area to display update interval (time; data 1 count of an area means 0.1ms) when updating module data for data sharing with XGT PLC.
- 2) In case module data is not entered at a specified interval (no. of operation channel\*40ms) due to occupation time of PLC scan program, it is possible to know the real update interval if using the data of the area.
- 3) In case processing data at regular intervals or using PV for control, it can be used for setting control interval (for the examples, refer to "Chapter 6 Programming").

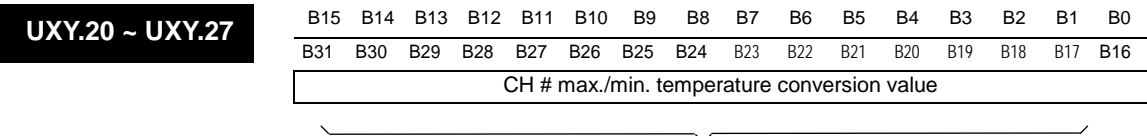

Address	Description
Address 20~21	Ch 0 Upload time of data
Address 22~23	Ch 1 Upload time of data
Address 24~25	Ch 2 Upload time of data
Address 26~27	Ch 3 Upload time of data

<Note> The area is cleared if a channel stops (output 0 if stoppage).

## 5.2.9 Command contact point

- 1) Bit 3~0: It outputs max./min. values of temperature entered while the command contact point is being set as 1. Until the bit of the area is and set as 0, it maintains the max./min. value. But, the function does not work if the channel stops although the area is allowed.
- 2) Bit 7~4: If the contact point bit to select alarm function provided by module (process alarm/gradient alarm) Enable or Disable is set as 1, the alarm function is allowed and it may output the alarm if it is within alarm condition depending on the settings. But, the function does not work if the channel stops although the area is allowed.
- 3) Bit B~8: Command contact point prohibiting or allowing cold junction compensation (RJC) of a channel. If the bit is set as 1, it does not support RJC. In general, the area is set as 0(allowed). But, in case of Type B sensor, it does not support RJC regardless of the area instruction.

**UXY.29**

B15	B14	B13	B12	B11	B10	B9	B8	B7	B6	B5	B4	B3	B2	B1	B0
—	—	—	—	R	R	R	R	A	A	A	A	F	F	F	F
				J	J	J	J	L	L	L	L	I	I	I	I
				C	C	C	C	M	M	M	M	N	N	N	N
				3	2	1	0	3	2	1	0	D	D	D	D
												3	2	1	0



FIND: Bit On (1): allowing max./min. output of a channel, Bit Off (0): prohibiting max./min. output of a channel  
 ALM: Bit On (1): allowing alarm function of a channel, Bit Off (0): suspending alarm function of a channel  
 RJC: Bit On (1): suspending cold junction compensation of a channel, Bit Off (0): cold junction compensation of a channel

## 5.3 Operation Parameter Setting Area

- ▶ Each address of internal memory is occupied by each word, which can be indicated with 16 bits.
- ▶ Each function can be embodied by setting “1” if 16 bits consisting of address is On or “0” if Off.

### 5.3.1 Designating Channel (Address 0) ;Channel status

- 1) Temperature conversion module Enable/Disable can be set to each channel.
- 2) By prohibiting a channel not to use from conversion, conversion interval by channels can be shortened.
- 3) If channel to use is not designated, every channel can not be used.
- 4) Temperature conversion module Enable/Disable are as follows.

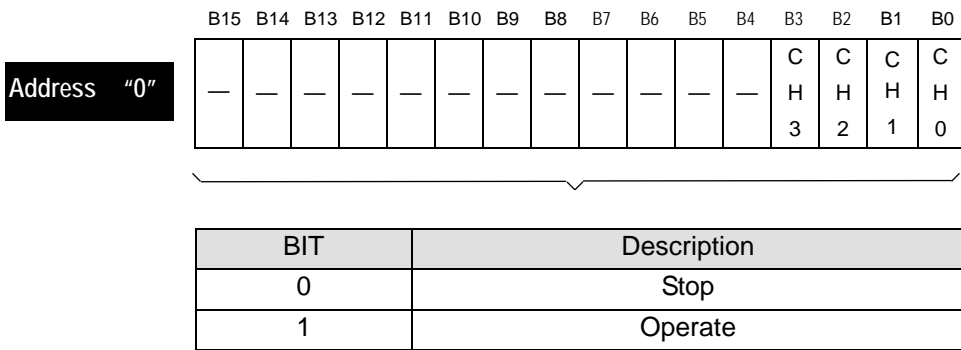

- 5) Values set in B4 ~ B15 are ignored.
- 6) The area shows the same results of operation channel designation in I/O parameter setting window.

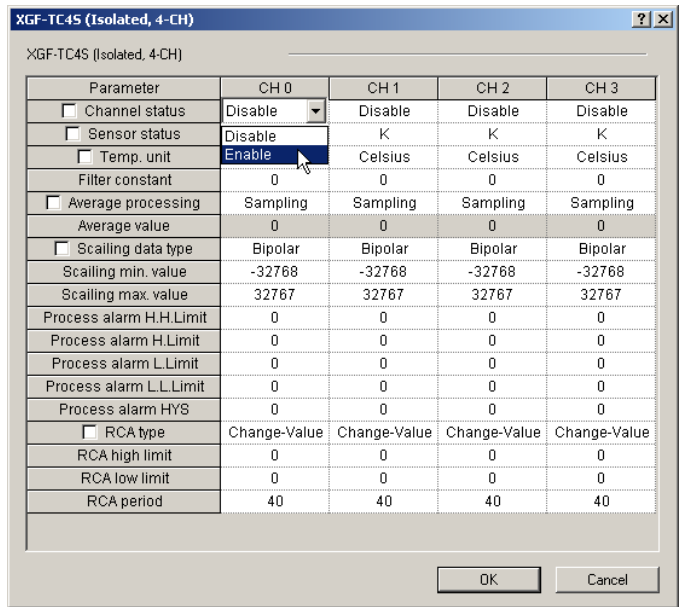

5.3.2 Sensor Type Setting Area (Address 1~4); Sensor status

1) Set the input sensor type by using the following codes.

Sensor type	K	J	E	T	B	R	S	N	C
No.	0	1	2	3	4	5	6	7	8

2) If set as 9 and over, 0(type K) is forcibly set internally.  
 But, UXY.01.8~ UXY.01.B(setting error flag) is On.  
 Refer to error info of setting error info area(address 60~63).

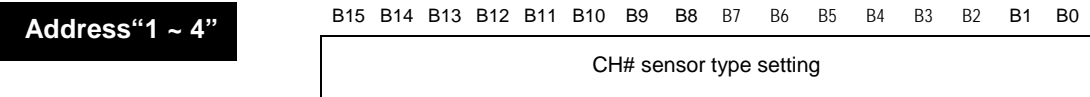

3) The area shows the same results of sensor type designation in I/O parameter setting window.

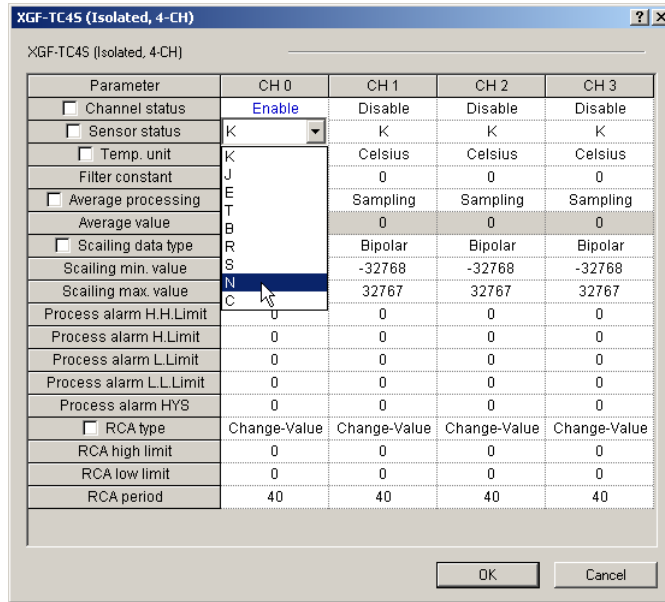

5.3.3 Temperature metric system indication area (Address 5); Temp. unit

1) If a bit is set as 1, the temperature conversion value of a channel is output in Fahrenheit.  
 (For Celsius-Fahrenheit conversion formula, refer to 'Chapter 2 Specifications'.)  
 2) Information set in bit 4~15 is ignored.

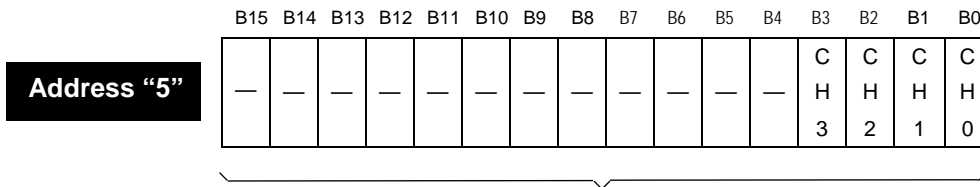

BIT	Description
0	Celsius
1	Fahrenheit



## Chapter 5 Configuration and Function of Internal Memory (For XGK)

- 3) The area shows the same results of temperature metric system designation in I/O parameter setting window.

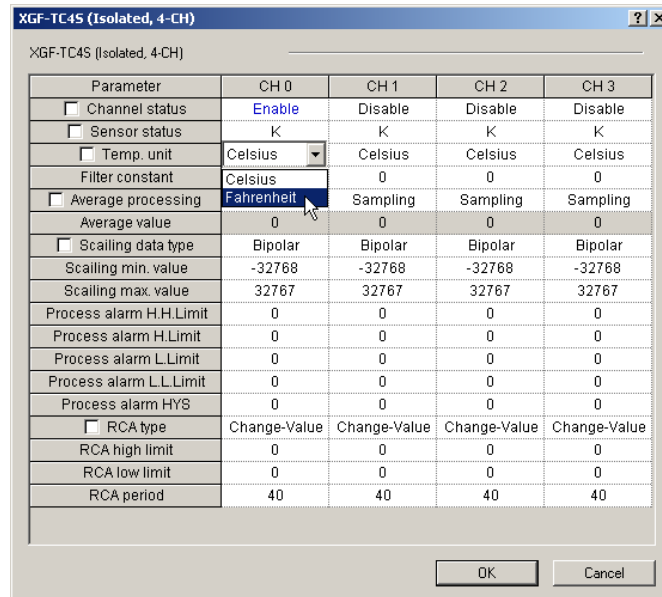

### 5.3.4 Filter value setting area (Address 6~9); Filter constant

- 1) If filter value is set as 0, it does not process filtering the channel and instead, outputs temperature conversion value sampling-processed.
- 2) If setting a value between 1 ~ 159 or over 64001, 0(filter prohibited) is set internally.  
: Uxy.01.8 ~ Uxy.01.B (setting error flag) is "On."  
(the bit, 1 of Setting error info area (address"60 ~ 63") would be On").

Address "6 ~ 9"

B15 B14 B13 B12 B11 B10 B9 B8 B7 B6 B5 B4 B3 B2 B1 B0

CH# filter value setting

Setting range is 160 ~ 64000ms

Address	Details
Address 6	CH0 filter value setting
Address 7	CH1 filter value setting
Address 8	CH2 filter value setting
Address 9	CH3 filter value setting

3) The area shows the same results of filter constant designation in I/O parameter setting window.

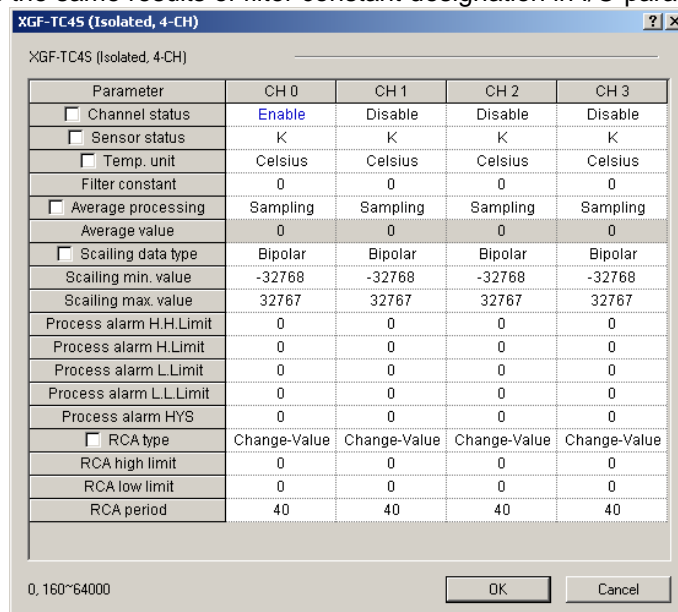

### 5.3.5 Averaging method setting area (Address 10~13); Average processing

- If set as 4 and over, 0(sampling) is set internally.  
: Uxy.01.8 ~ Uxy.01.B (setting error flag)is "On".  
(the bit, 2 of setting error info area(address 60 ~ 63) is "On".

**Address "10 ~ 13"**

B15	B14	B13	B12	B11	B10	B9	B8	B7	B6	B5	B4	B3	B2	B1	B0
CH# averaging method designation 0 : sampling process 1 : time averaging 2 : count averaging 3 : moving averaging															

Address	Details
Address 10	CH0 averaging method setting
Address 11	CH1 averaging method setting
Address 12	CH2 averaging method setting
Address 13	CH3 averaging method setting

## Chapter 5 Configuration and Function of Internal Memory (For XGK)

2) The area shows the same results of averaging designation in I/O parameter setting window.

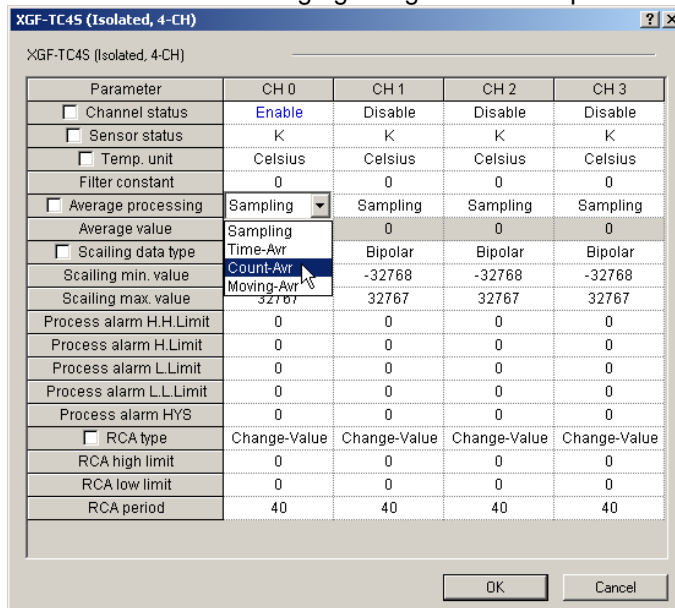

## 5.3.6 Average setting area (Address 14~17); Average value

- 1) If averaging process is sampling, the area has no concern with the setting.
- 2) If any other value but the above value is set, the boundary values of each range are set internally.  
 : Uxy.01.8 ~ Uxy.01.B (setting error flag) is "On".  
 (the bit, 3 of setting error info area(address 60 ~ 63) will be "On".  
 i.e.) If time average is selected and the average is set as 200, it operates with 320 forcibly set internally.
- 3) However, if parameter window of XG5000 is used, package provides prohibition function to prevent any out of range value from being set(if incorrectly set, it indicates the value in red and shows a message to re-set).

Address "14 ~ 17"

B15 B14 B13 B12 B11 B10 B9 B8 B7 B6 B5 B4 B3 B2 B1 B0  

CH# average setting  
 Time average: 320 ~ 64000 [ms]  
 Frequency average : 2 ~ 64000 [times]  
 Moving average : 2 ~ 100 [pieces]

Address	Details
Address 14	CH0 average setting
Address 15	CH1 average setting
Address 16	CH2 average setting
Address 17	CH3 average setting

- 4) The area shows the same results of average value designation in I/O parameter setting window.

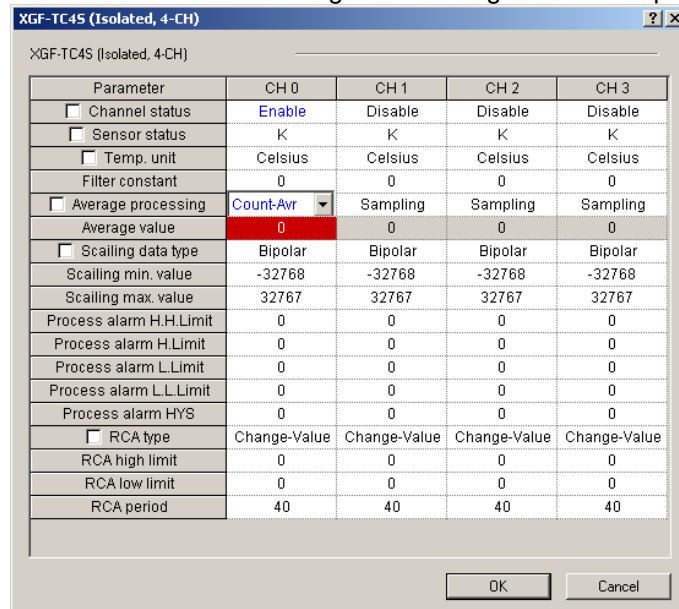

## 5.3.7 Scale type setting area (Address 18); Scaling data type

- 1) Scale operation is output in 16 bits without mark (0 ~ 65535) or 16 bits (-32768 ~ 32767) with mark.
- 2) Information designated in bit 4~15 is ignored.

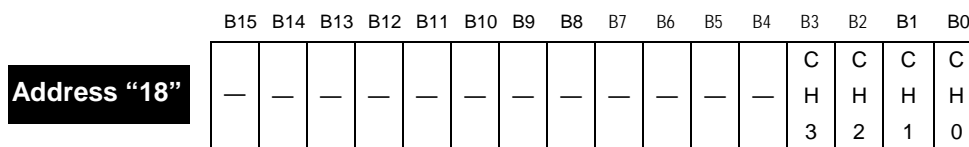

BIT	Description
0	Integer with mark
1	Integer without mark

- 3) The area shows the same results of scaling data type designation in I/O parameter setting window.

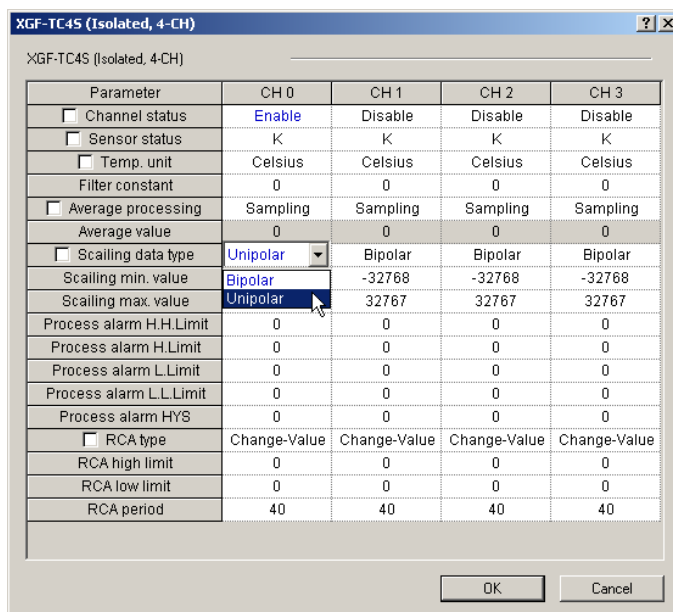

## 5.3.8 Min./Max. scale range setting area (Address 19~26); Scaling Min. value/Max. value

1) If any out-of-range value is set, the settings stored in the module is maintained.

: Uxy.01.8 ~ Uxy.01.B (setting error flag) is "On."

The bit, 4(min) or 5(max) of setting error info area (address 60 ~ 63) is "On."

Address "19 ~ 26"

B15 B14 B13 B12 B11 B10 B9 B8 B7 B6 B5 B4 B3 B2 B1 B0

With mark : -32768 ~ 32767  
Without mark : 0 ~ 65535

Address	Description
Address 19	CH 0 min. scale range setting area
Address 20	CH 0 max. scale range setting area
Address 21	CH 1 min. scale range setting area
Address 22	CH 1 max. scale range setting area
Address 23	CH 2 min. scale range setting area
Address 24	CH 2 max. scale range setting area
Address 25	CH 3 min. scale range setting area
Address 26	CH 3 max. scale range setting area

2) The area shows the same results of min./max. scaling value of I/O parameter.

XGF-TC45 (Isolated, 4-CH)

Parameter	CH 0	CH 1	CH 2	CH 3
<input type="checkbox"/> Channel status	Disable	Disable	Disable	Disable
<input type="checkbox"/> Sensor status	K	K	K	K
<input type="checkbox"/> Temp. unit	Celsius	Celsius	Celsius	Celsius
Filter constant	0	0	0	0
<input type="checkbox"/> Average processing	Sampling	Sampling	Sampling	Sampling
Average value	0	0	0	0
<input type="checkbox"/> Scaling data type	Bipolar	Bipolar	Bipolar	Bipolar
Scaling min. value	-32768	-32768	-32768	-32768
Scaling max. value	32767	32767	32767	32767
Process alarm H.H.Limit	0	0	0	0
Process alarm H.Limit	0	0	0	0
Process alarm L.Limit	0	0	0	0
Process alarm L.L.Limit	0	0	0	0
Process alarm HYS	0	0	0	0
<input type="checkbox"/> RCA type	Change-Value	Change-Value	Change-Value	Change-Value
RCA high limit	0	0	0	0
RCA low limit	0	0	0	0
RCA period	40	40	40	40

OK Cancel

XGF-TC45 (Isolated, 4-CH)

Parameter	CH 0	CH 1	CH 2	CH 3
<input type="checkbox"/> Channel status	Disable	Disable	Disable	Disable
<input type="checkbox"/> Sensor status	K	K	K	K
<input type="checkbox"/> Temp. unit	Celsius	Celsius	Celsius	Celsius
Filter constant	0	0	0	0
<input type="checkbox"/> Average processing	Sampling	Sampling	Sampling	Sampling
Average value	0	0	0	0
<input type="checkbox"/> Scaling data type	Unipolar	Bipolar	Bipolar	Bipolar
Scaling min. value	0	-32768	-32768	-32768
Scaling max. value	32767	32767	32767	32767
Process alarm H.H.Limit	0	0	0	0
Process alarm H.Limit	0	0	0	0
Process alarm L.Limit	0	0	0	0
Process alarm L.L.Limit	0	0	0	0
Process alarm HYS	0	0	0	0
<input type="checkbox"/> RCA type	Change-Value	Change-Value	Change-Value	Change-Value
RCA high limit	0	0	0	0
RCA low limit	0	0	0	0
RCA period	40	40	40	40

0~32766

OK Cancel

**5.3.9 Process alarm boundary value setting area (Address 27~42) ; Process alarm H.H. Limit, Process alarm H. Limit, Process alarm L. Limit, Process alarm L.L. Limit**

- 1) Setting range can be set separately according to sensor type and temperature unit (Celsius/Fahrenheit)
- 2) If setting is out of range, setting error occurs and previous value is kept.

B15 B14 B13 B12 B11 B10 B9 B8 B 7 B 6 B 5 B 4 B 3 B 2 B1 B0

**Address“27 ~ 42”**

CH# process alarm boundary value  
 H.H. setting value: max. temperature ~ max. H. value  
 H. setting value : max. H. value ~ max. L. value  
 L. setting value : max. L. value ~ max. L.L. value  
 L.L. setting value : max. L.L. value ~ min. temperature

Address	Description
Address 27	CH 0 process alarm H.H. value setting area
Address 28	CH 0 process H. value setting area
Address 29	CH 0 process alarm L. value setting area
Address 30	CH 0 process alarm L.L. value setting area
Address 31	CH 1 process alarm H.H. value setting area
Address 32	CH 1 process H. value setting area
Address 33	CH 1 process alarm L. value setting area
Address 34	CH 1 process alarm L.L. value setting area
Address 35	CH 2 process alarm H.H. value setting area
Address 36	CH 2 process H. value setting area
Address 37	CH 2 process alarm L. value setting area
Address 38	CH 2 process alarm L.L. value setting area
Address 39	CH 3 process alarm H.H. value setting area
Address 40	CH 3 process H. value setting area
Address 41	CH 3 process alarm L. value setting area
Address 42	CH 3 process alarm L.L. value setting area

- 3) The area shows the same results of process alarm boundary value designation of I/O parameter.

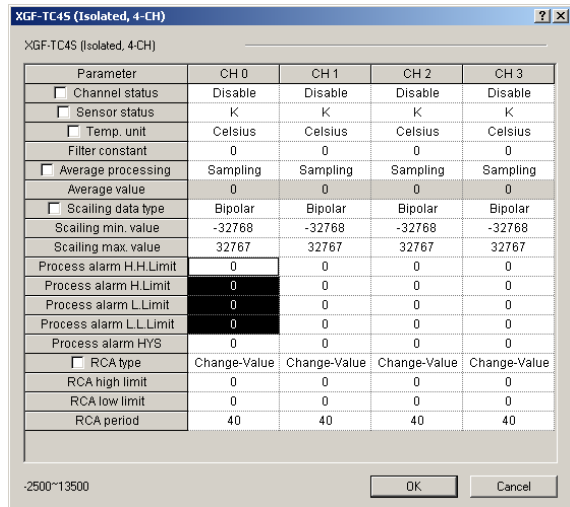

**5.3.10 Process alarm Hysteresis setting area (Address 43~46); Process alarm HYS**

- 1) If it is set out-of-range, 0 (no hysteresis) is set internally.
- 2) If it is within the range even in alarm reset condition during use of process alarm function, it maintains alarm output

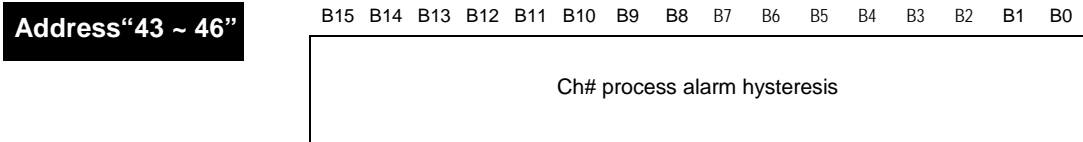

Address	Description
Address 43	CH 0 process alarm hysteresis setting area
Address 44	CH 1 process alarm hysteresis setting area
Address 45	CH 2 process alarm hysteresis setting area
Address 46	CH 3 process alarm hysteresis setting area

- 3) The area shows the same results of process alarm hysteresis designation of I/O parameter.

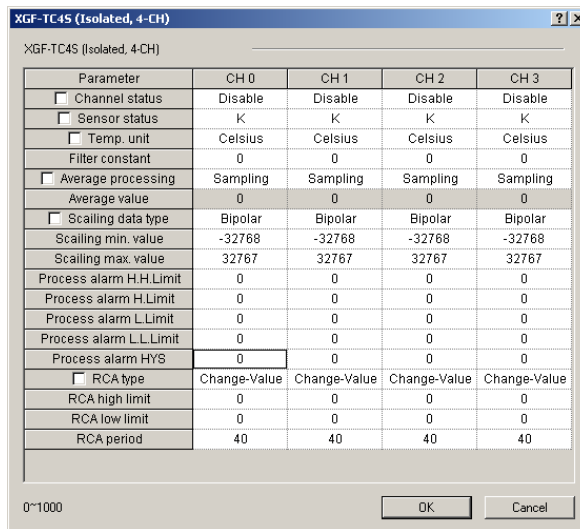



## 5.3.11 Alarm type setting area of rate-change-alarm (Address 47); RCA type

- 1) If this bit is set as 1, change rate (rate about input range according to sensor type) is used as standard of alarm output.
- 2) If this bit is set as 0, temperature change is used as standard of alarm output.
- 3) Information designated in bit 4~F is ignored.

Address "47"

B15	B14	B13	B12	B11	B10	B9	B8	B7	B6	B5	B4	B3	B2	B1	B0
—	—	—	—	—	—	—	—	—	—	—	—	C	C	C	C
												H	H	H	H
												3	2	1	0

BIT	Description
0	Temperature change
1	Temperature rate-change

- 3) The area shows the same results of rate-change-alarm setting type of I/O parameter.

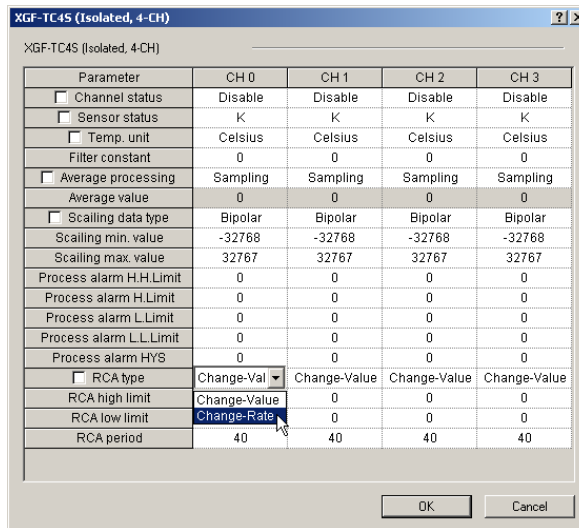

**5.3.12 Rate-change alarm H./L. boundary value setting area (Address 48~55);  
RCA high limit, RCA low limit**

- 1) If it is set out-of-range, it maintains the settings saved in module
- 2) In case RCV type is Change-Rate, this becomes percentile value indicating first decimal point
- 3) In case RCV type is Change-Value, this becomes temperature value.

**Address“48 ~ 55”**

B15 B14 B13 B12 B11 B10 B9 B8 B7 B6 B5 B4 B3 B2 B1 B0

CH# Rate-change-alarm H/L boundary value:-1000~1000

Address	Description
Address 48	CH 0 gradient alarm H. boundary value setting area
Address 49	CH 0 gradient alarm L. boundary value setting area
Address 50	CH 1 gradient alarm H. boundary value setting area
Address 51	CH 1 gradient alarm L. boundary value setting area
Address 52	CH 2 gradient alarm H. boundary value setting area
Address 53	CH 2 gradient alarm L. boundary value setting area
Address 54	CH 3 gradient alarm H. boundary value setting area
Address 55	CH 3 gradient alarm L. boundary value setting area

4) The area shows the same results of gradient alarm H./L. designation of I/O parameter.

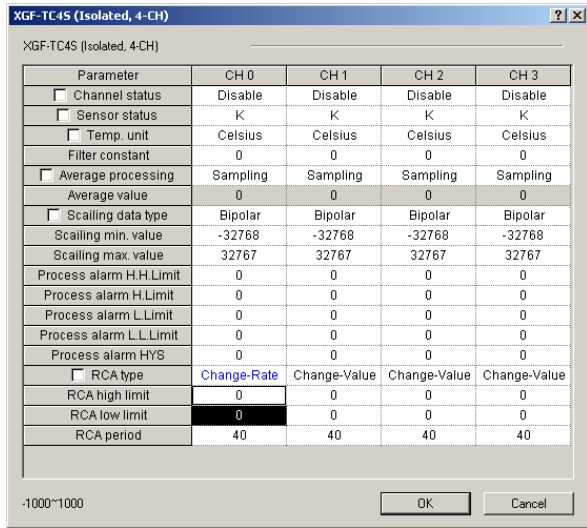

## 5.3.13 Rate-change-alarm detection period setting area (Address 56~59)

- 1) Area to set the detection interval in case rate-change alarm function is used.
- 2) If any out-of-range value is set, it sets 40[ms] internally.

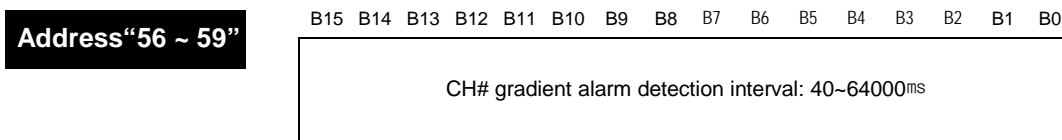

Address	Description
Address 56	CH 0 gradient alarm detection interval setting area
Address 57	CH 1 gradient alarm detection interval setting area
Address 58	CH 2 gradient alarm detection interval setting area
Address 59	CH 3 gradient alarm detection interval setting area

- 3) The area shows the same results of gradient alarm detection period designation of I/O parameter.

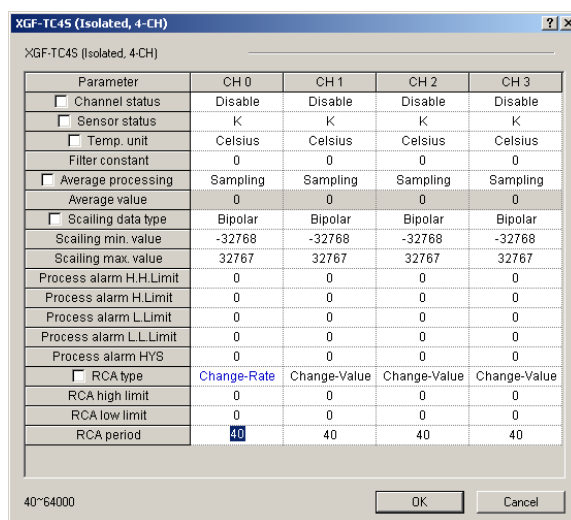

**5.4 Other Data Monitoring Setting Area**

► It describes the area to monitor flag information for setting error in case of setting operation parameter with program and read input gradient for detection interval if gradient alarm is used. In addition, it describes how to read error code in case of sensor disconnection and monitor cold junction temperature.

**5.4.1 Setting error information output area (Address 60~63)**

- 1) In case settings are out-of-range(if set by program), the bit is output with 1.
- 2) Setting error is reset as long as it is re-set within normal range by reset.
- 3) In case of setting error, module LED does not change. In case the junction of Uxy.01.08~Uxy.01.0B is On, checks the area and fixes the area correctly.

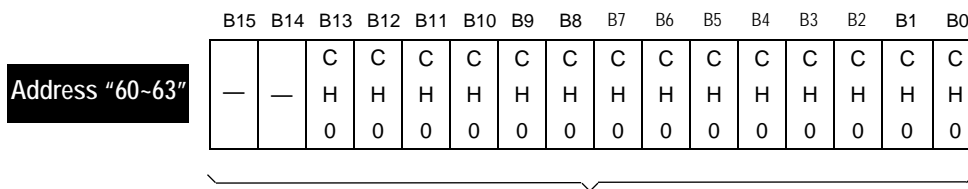

BIT	Description	Address
0	Sensor type setting error	1~4
1	Filter value setting error	6~9
2	Averaging type setting error	10~13
3	Average value setting error	14~17
4	Min. scale range setting error	19,21,23,25
5	Max. scale range setting error	20,22,24,26
6	H.H. process alarm value setting error	27,31,35,39
7	H. process alarm value setting error	28,32,36,40
8	L. process alarm value setting error	29,33,37,41
9	L.L. process alarm value setting error	30,34,38,42
A	Process alarm hysteresis setting error	39~46
B	H. gradient alarm value setting error	48,50,52,54
C	L. gradient alarm value setting error	49,51,53,55
D	Gradient alarm detection interval setting error	56~59

Address	Description
Address 60	CH 0 setting error info display area
Address 61	CH 1 setting error info display area
Address 62	CH 2 setting error info display area
Address 63	CH 3 setting error info display area

## 5.4.2 Rate-change alarm Change-value (Change-rate) output area (address 64~67)

- 1) It outputs temperature changed during detection interval set or the gradient (% of sensor range).
- 2) You can monitor at [Special Module Monitor] window

Address "64 ~ 67"

B15 B14 B13 B12 B11 B10 B9 B8 B7 B6 B5 B4 B3 B2 B1 B0

CH# gradient alarm change output area:-1000~1000

Address	Description
Address 64	CH 0 gradient alarm change output area
Address 65	CH 1 gradient alarm change output area
Address 66	CH 2 gradient alarm change output area
Address 67	CH 3 gradient alarm change output area

- 2) The area shows the same results of I/O parameter gradient designation.

**Special Module Monitor**

XGF-TC4S (Isolated, 4-CH)

Item	CH 0	CH 1
Temperature value	599	608
Scalling value	-20074	-20037
Min. temp value	596	605
Max. temp value	601	609
Input change(value/rate)	0	0

Item	CH 2	CH 3
Temperature value	590	594
Scalling value	-20111	-20095
Min. temp value	587	591
Max. temp value	588	592
Input change(value/rate)	0	0

Item	Setting value	Current value
Channel CH 0		
Channel status	Disable	Enable
Sensor type	K	K
Temp. unit	Celsius	Celsius
Filter constant	0	0
Average processing	Sampling	Sampling
Average value	0	0
Scalling data type	Bipolar	Bipolar
Scalling min. value	-32768	-32768
Scalling max. value	32767	32767
Process alarm H.H.Limit	0	0
Process alarm H.Limit	0	0
Process alarm L.Limit	0	0
Process alarm L.Limit	0	0
Process alarm HYS	0	0
RCA type	Change-Value	Change-Value
RCA high limit	0	0
RCA low limit	0	0
RCA period	40	40

Buttons: Stop Monitoring, Test, Close

**5.4.3 Sensor disconnection information output area (Address 68~71)**

- 1) If any disconnection code occurs in the area, check the sensor's connection of a channel.
- 2) In case of thermocouple sensor disconnection, temperature output displays the max. output.
- 3) In case of cold junction sensor disconnection, temperature output is output without RJC compensated.

**Address "68 ~ 71"**

B15 B14 B13 B12 B11 B10 B9 B8 B7 B6 B5 B4 B3 B2 B1 B0

CH# sensor disconnection info output 0: normal sensor connection 1: thermocouple sensor disconnection 2: cold junction sensor disconnection
--

Address	Description
Address 68	CH 0 sensor disconnection info output area
Address 69	CH 1 sensor disconnection info output area
Address 70	CH 2 sensor disconnection info output area
Address 71	CH 3 sensor disconnection info output area

**5.4.4 Cold junction compensation temperature output area (Address 72~75)**

- 1) It is the area displaying RJC sensor measuring temperature for reference junction temperature compensation.

**Addrss "72 ~ 75"**

B15 B14 B13 B12 B11 B10 B9 B8 B7 B6 B5 B4 B3 B2 B1 B0

CH# terminal strip compensation temperature
---

Address	Description
Address 72	CH 0 cold junction compensation temperature output area
Address 73	CH 1 cold junction compensation temperature output area
Address 74	CH 2 cold junction compensation temperature output area
Address 75	CH 3 cold junction compensation temperature output area



## Chapter 6 Programming (For XGK)

### 6.1 Read/Write Operation Parameter Setting Area

It describes internal memory configuration.

#### 6.1.1 Read operation parameter setting area (GET, GETP Instruction)

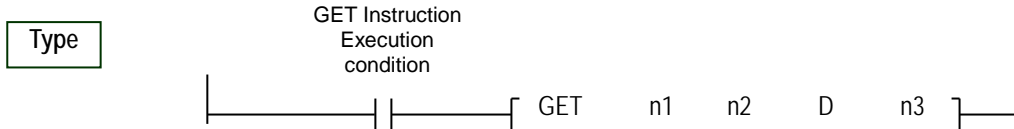

Type	Description	Available area
n1	Slot # with special module	Integer
n2	Initial address of special module operation parameter setting area to read data	Integer
D	Initial address of device to save data to read	M, P, K, L, T, C, D, #D
n3	No. of words to read	Integer

< Difference of GET instruction and GETP instruction >

GET: always execute with execution condition of On. ( )  
 GETP: execute with commencement of operation in execution condition. ( )

i.e. In case thermocouple module is installed on #0 base and #3 base and the internal memory address 0, 1 data of thermocouple module is read by CPU module D0 and D1;

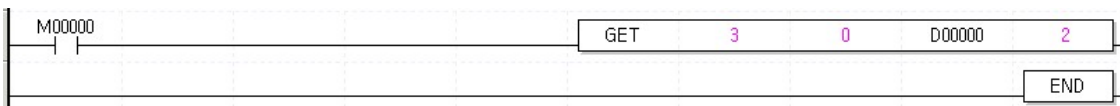
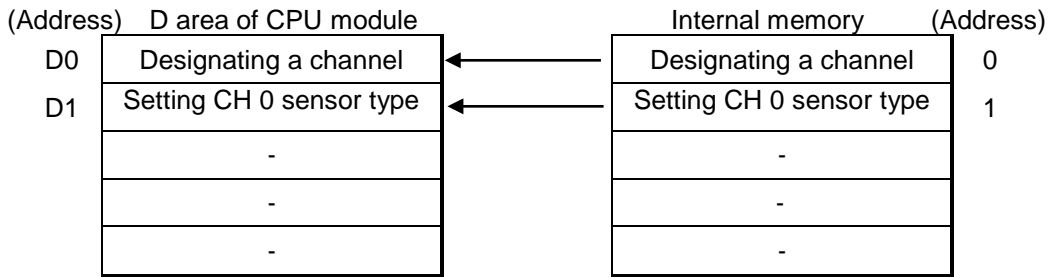



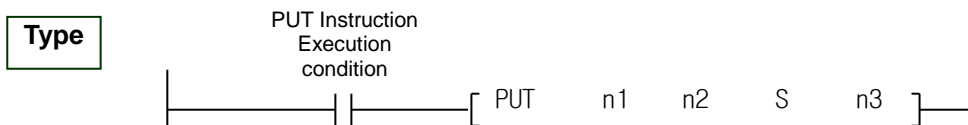

6.1.2 Write operation parameter area (PUT, PUTP instruction)



Type	Description	Available area
n1	Slot # with special module	Integer
n2	Initial address of special module internal memory to write data	Integer
S	Initial address or integer of a device containing data to write	M, P, K, L, T, C, D, #D, integer
n3	No. of words to write	Integer

< Difference of PUT instruction and PUTP instruction >

PUT: always execute with execution condition of On (  )  
 PUTP: execute with commencement of operation in execution condition (  )

**i.e.** In case thermocouple module is installed on #0 base and #6 slot and the internal memory address 1 ~ 4 of thermocouple module is written to CPU module D3 ~ D6.

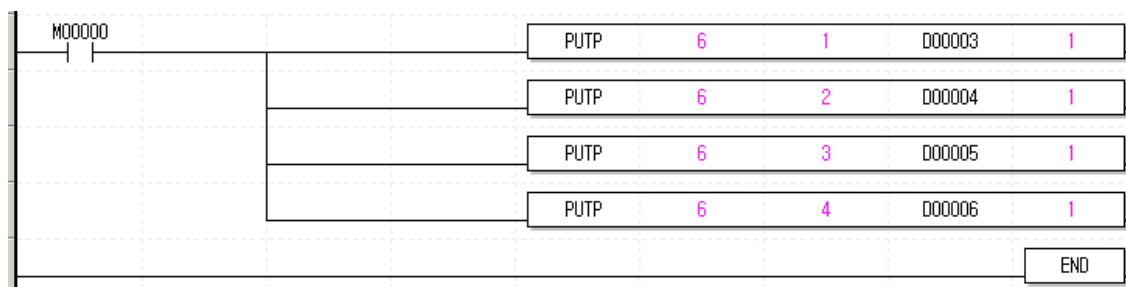
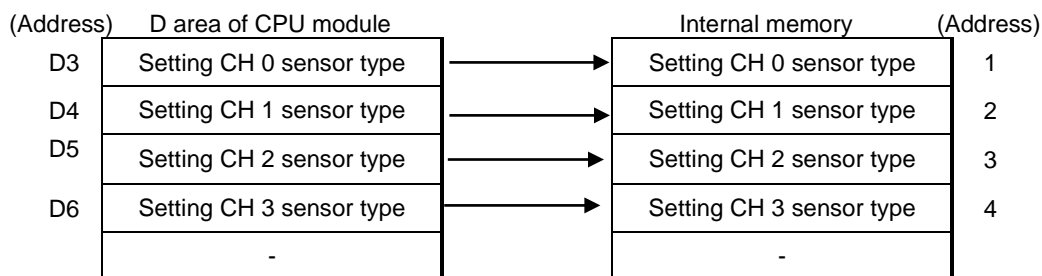

## 6.2 Basic Program

- It describes how to set operation conditions in the internal memory of thermocouple module.
- Thermocouple module is installed on slot 2.
- I/O occupation points of thermocouple module is 64(fixed).
- Regarding the initial condition, the initial settings are saved in the internal memory of thermocouple module if saved once.

### 1) Example using [I/O Parameter] setting

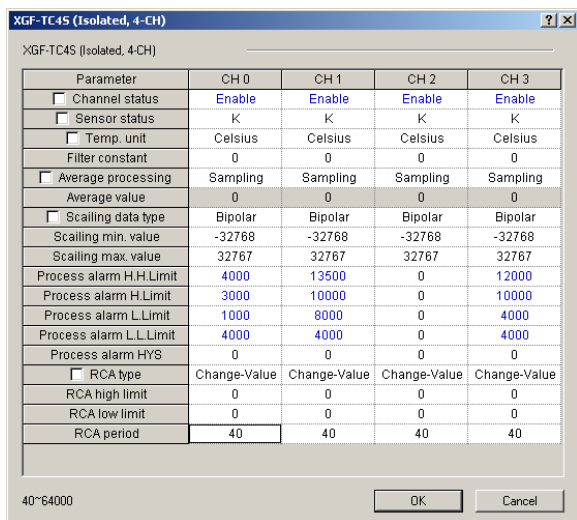
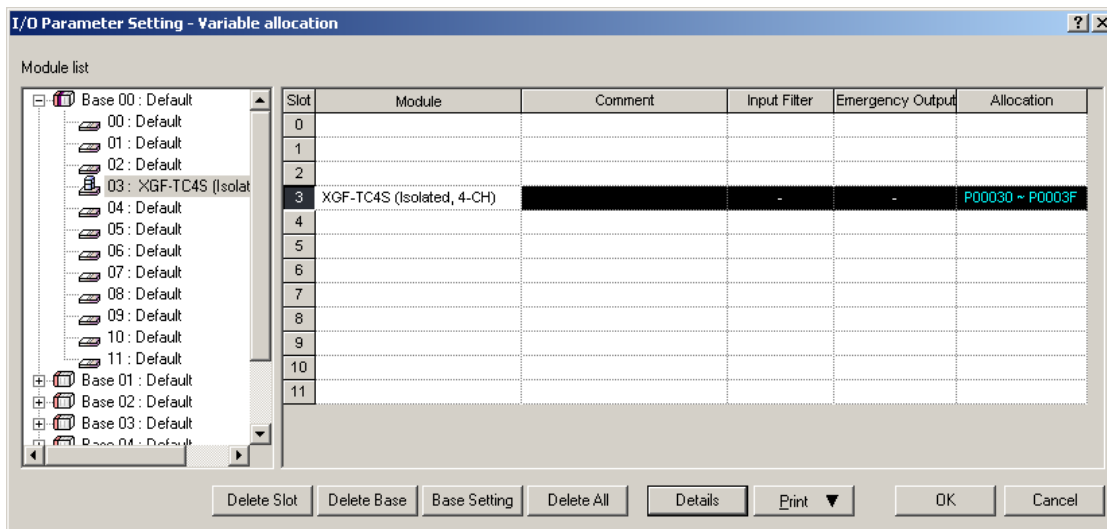

► Register module at IO parameter and Download the project to PLC after setting operation parameter.

# Chapter 6 Programming (For XGK)

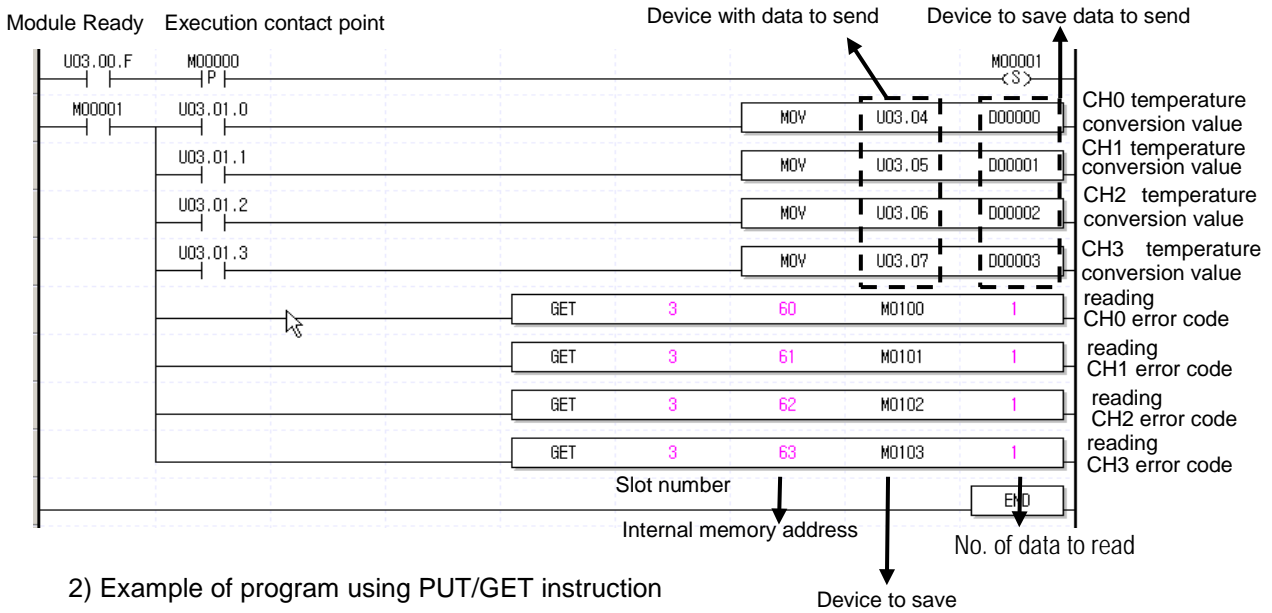

2) Example of program using PUT/GET instruction

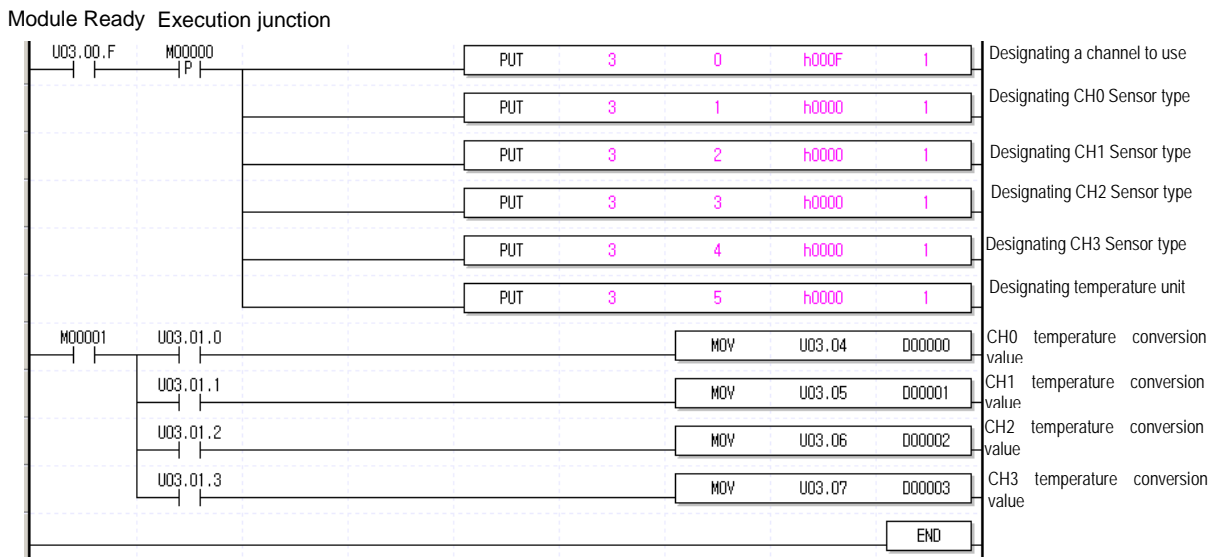

**6.3 Application Program**

**6.3.1 Temperature conversion value determination program**

(I/O slot fixation point assignment: 64 point)

1) System Configuration

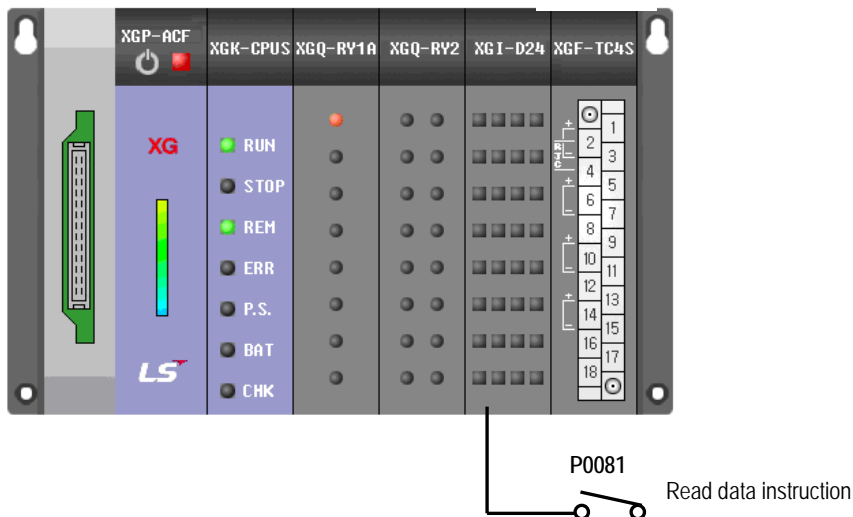

2) Initial Settings

No.	Item	Initial settings	Internal memory address	Value to write to internal memory
1	CH	CH0, CH1	0	'h0003' or '3'
2	Sensor type	CH0 : type K	1	'h0000' or '0'
		CH1 : type K	2	'h0000' or '0'
3	Temperature indication	Celsius	5	'h0000' or '0'

3) Program Description

- (1) If P0081 is On, it reads data into internal memory of thermocouple input module.
- (2) If the temperature input through CH0 is lower than -20°C or larger than -30 °C, P0000 is On.
- (3) If the temperature input through CH1 is lower than -20°C or larger than -30 °C, P0001 is On.
- (4) If the difference of temperatures input through CH0 and CH1 is larger than 5°C, P0002 is On.

- XGF-TC4S module is installed on the basic base #3 slot of XGK PLC
- Set CH0 and CH1 as type K
- Indicate CH0 and CH1 as Celsius

## 4) Program

### (1) Example of program using [I/O Parameter] setting

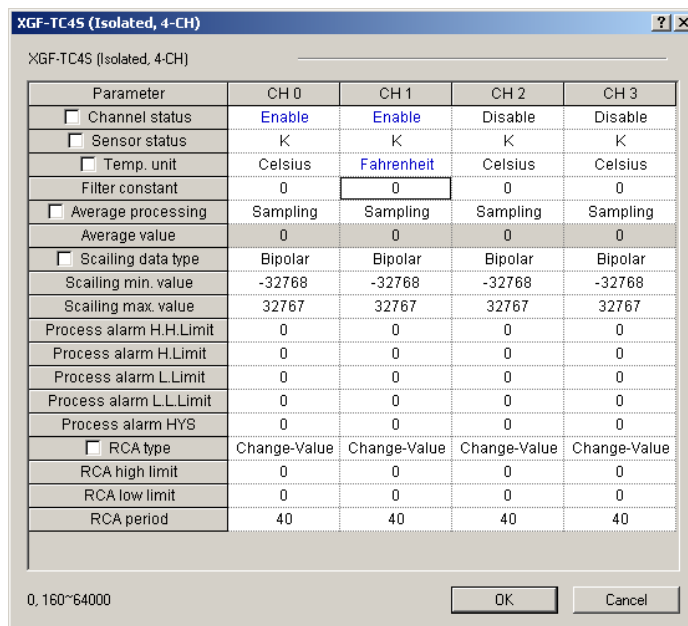
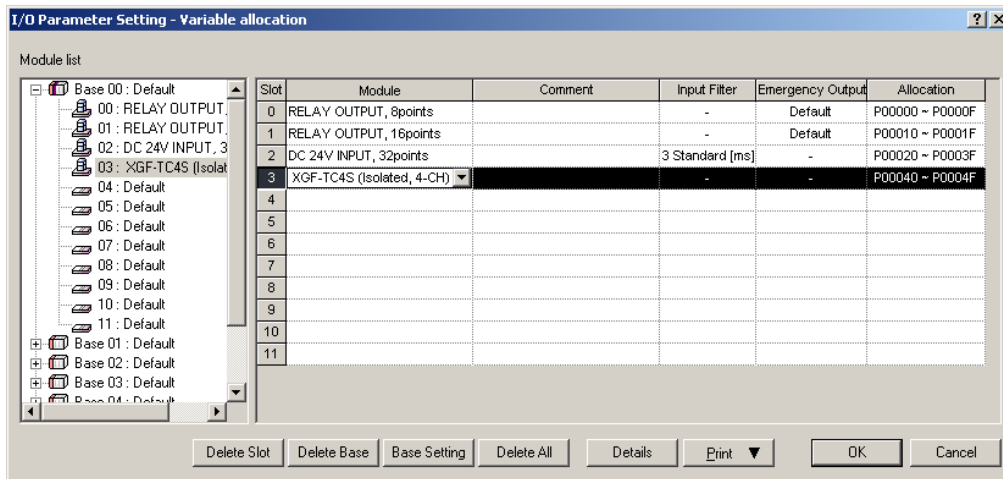

**Remark**  
 If every channel is set identically in the above parameter setting window, tick(✓) in the checkbox and set only one channel. Then, every channel would have the same setting.

# Chapter 6 Programming (For XGK)

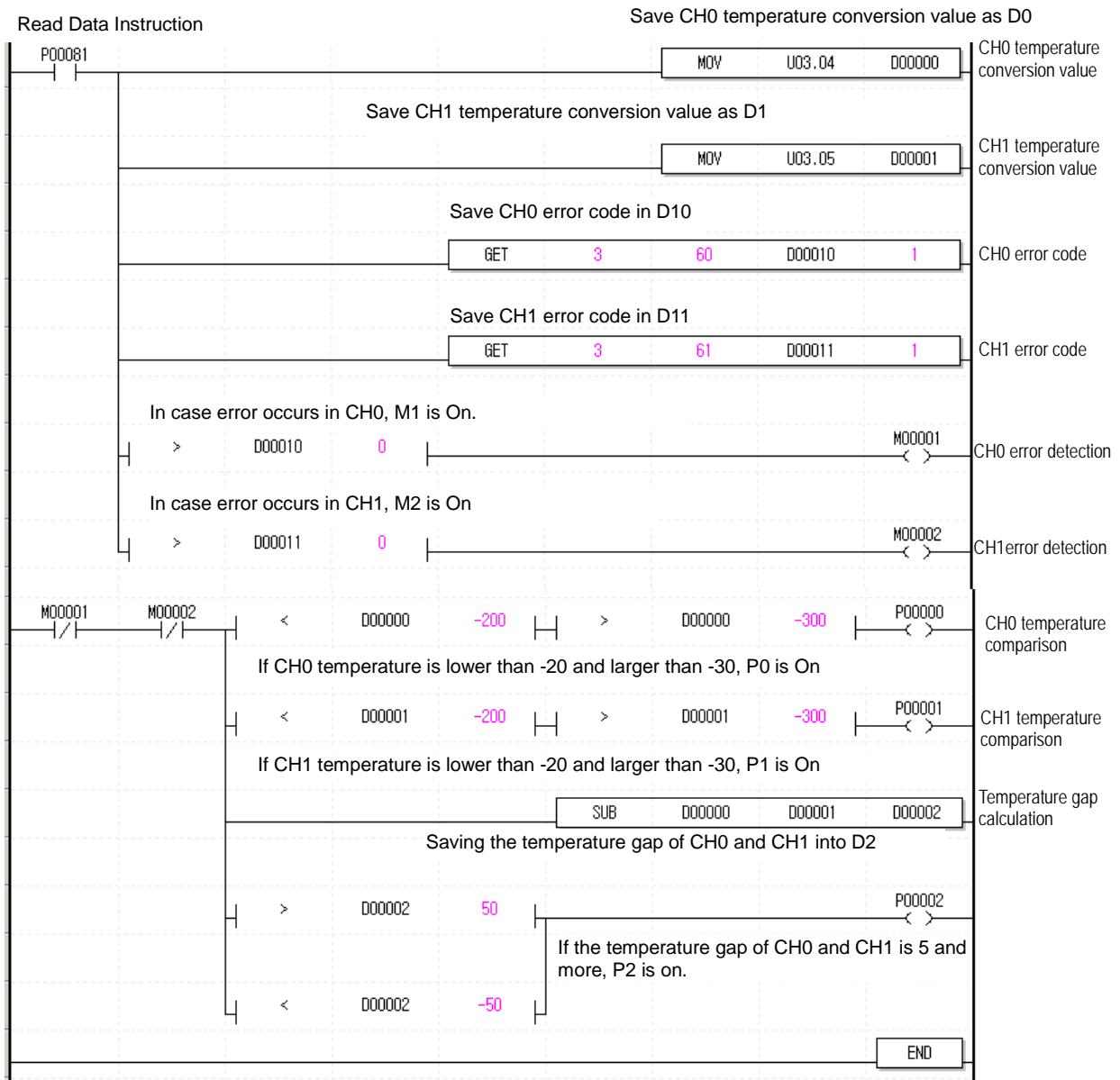

6.3.2 CH data monitor program (I/O slot fixation point assignment: 64points)

: This program saves temperature conversion output into Device K if channel is operating with module ready or saves min./max. value of channel to Device D if channel max./min. searching junction is allowed.

1) Program

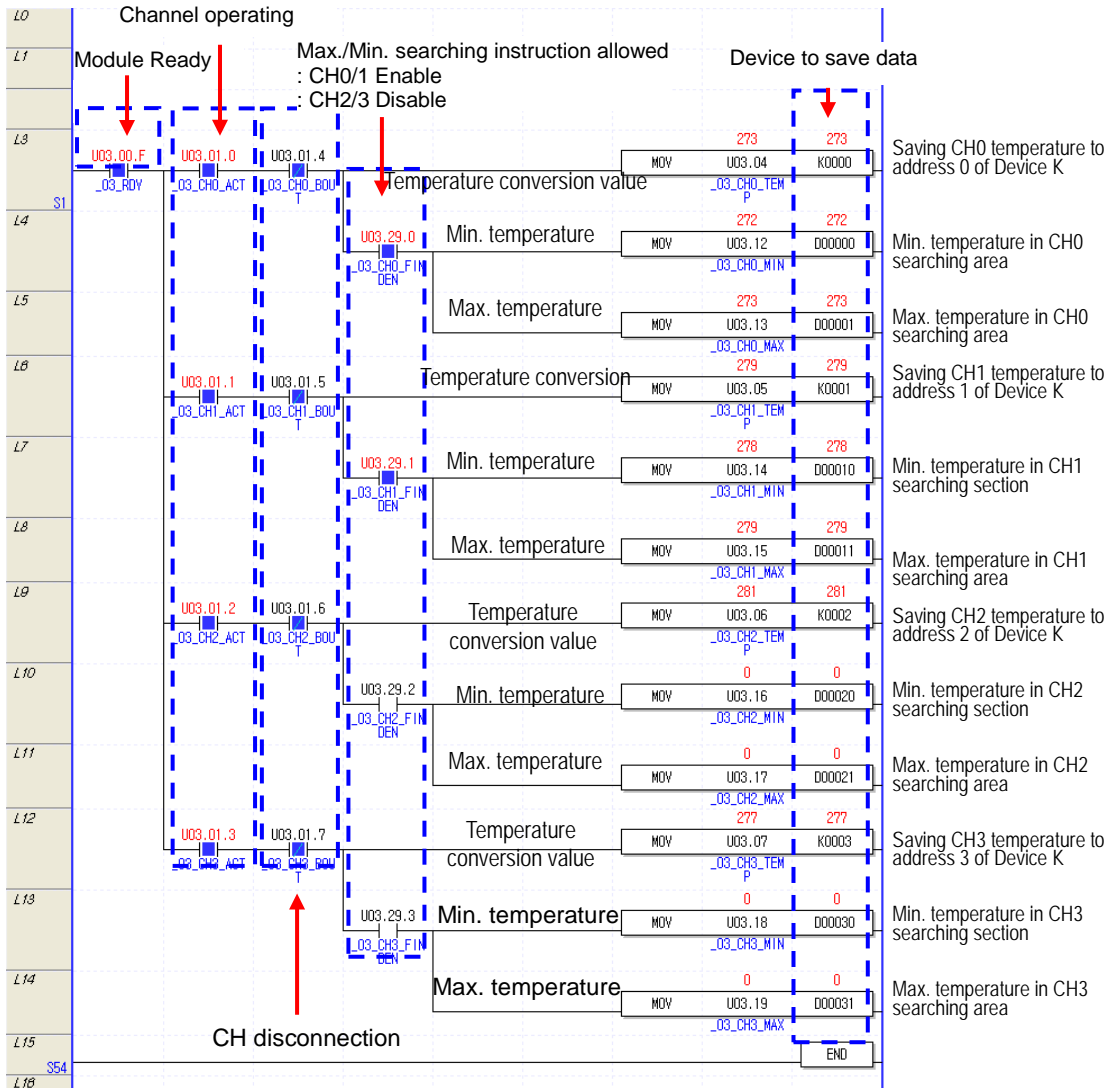

2) Viewing CH data in special module monitoring window

**Special Module Monitor** XGF-TC4S (Isolated, 4-CH)

Item	CH 0	CH 1
Temperature value	597	606
Scalling value	-20082	-20046
Min. temp value	596	605
Max. temp value	598	606
Input change(value/rate)	0	0
Item	CH 2	CH 3
Temperature value	588	592
Scalling value	-20119	-20103
Min. temp value	587	591
Max. temp value	588	592
Input change(value/rate)	0	0
FLAG Monitor		

Item	Setting value	Current value
Channel	CH 3	
Channel status	Enable	Enable
Sensor type	K	K
Temp. unit	Celsius	Celsius
Filter constant	0	0
Average processing	Sampling	Sampling
Average value	0	0
Scalling data type	Bipolar	Bipolar
Scalling min. value	-32768	-32768
Scalling max. value	32767	32767
Process alarm H.H.Limit	0	0
Process alarm H.Limit	0	0
Process alarm L.Limit	0	0
Process alarm L.Limit	0	0
Process alarm HYS	0	0
RCA type	Change-Value	Change-Value
RCA high limit	0	0
RCA low limit	0	0
RCA period	40	40

Buttons: Stop Monitoring, Test, Close

**Temp. Measuring Module Command** XGF-TC4S (Isolated, 4-CH)

Item	CH 0	CH 1
Channel status	Run	Run
Sensor status	Normal	Normal
Process alarm(H.H.Limit)	OFF	OFF
Process alarm(H.Limit)	OFF	OFF
Process alarm(L.Limit)	OFF	OFF
Process alarm(L.L.Limit)	OFF	OFF
RCA high limit	OFF	OFF
RCA low limit	OFF	OFF
Item	CH 2	CH 3
Channel status	Run	Run
Sensor status	Normal	Normal
Process alarm(H.H.Limit)	OFF	OFF
Process alarm(H.Limit)	OFF	OFF
Process alarm(L.Limit)	OFF	OFF
Process alarm(L.L.Limit)	OFF	OFF
RCA high limit	OFF	OFF
RCA low limit	OFF	OFF

Command	CH 0	CH 1
Max/Min active	ENABLE	ENABLE
Alarm active	DISABLE	DISABLE
RJC Active	ENABLE	ENABLE
Command	CH 2	CH 3
Max/Min active	DISABLE	DISABLE
Alarm active	DISABLE	DISABLE
RJC Active	ENABLE	ENABLE

Buttons: Cancel



### 6.3.3 Other data monitor program

- XGF-TC4S module is installed on the basic base #3 slot of XGK PLC.
- Every channel is set to Type K.
- Every channel displays temperature in Celsius.

#### 1) Operation Parameter Setting

Parameter	CH 0	CH 1	CH 2	CH 3
<input checked="" type="checkbox"/> Channel status	Enable	Enable	Enable	Enable
<input checked="" type="checkbox"/> Sensor status	K	K	K	K
<input checked="" type="checkbox"/> Temp. unit	Celsius	Celsius	Celsius	Celsius
Filter constant	0	0	0	0
<input type="checkbox"/> Average processing	Sampling	Sampling	Sampling	Sampling
Average value	0	0	0	0
<input type="checkbox"/> Scaling data type	Bipolar	Bipolar	Bipolar	Bipolar
Scaling min. value	-32768	-32768	-32768	-32768
Scaling max. value	32767	32767	32767	32767
Process alarm H.H.Limit	0	0	0	0
Process alarm H.Limit	0	0	0	0
Process alarm L.Limit	0	0	0	0
Process alarm L.L.Limit	0	0	0	0
Process alarm HYS	0	0	0	0
<input type="checkbox"/> RCA type	Change-Rate	Change-Value	Change-Value	Change-Value
RCA high limit	0	0	0	0
RCA low limit	0	0	0	0
RCA period	40	40	40	40

## Chapter 6 Programming (For XGK)

### 2) Program

: It saves temperature conversion output of a channel to Device K if channel is operating with module ready and it is not disconnected or calculates and shows update interval of module data(update interval is saved in Device D).

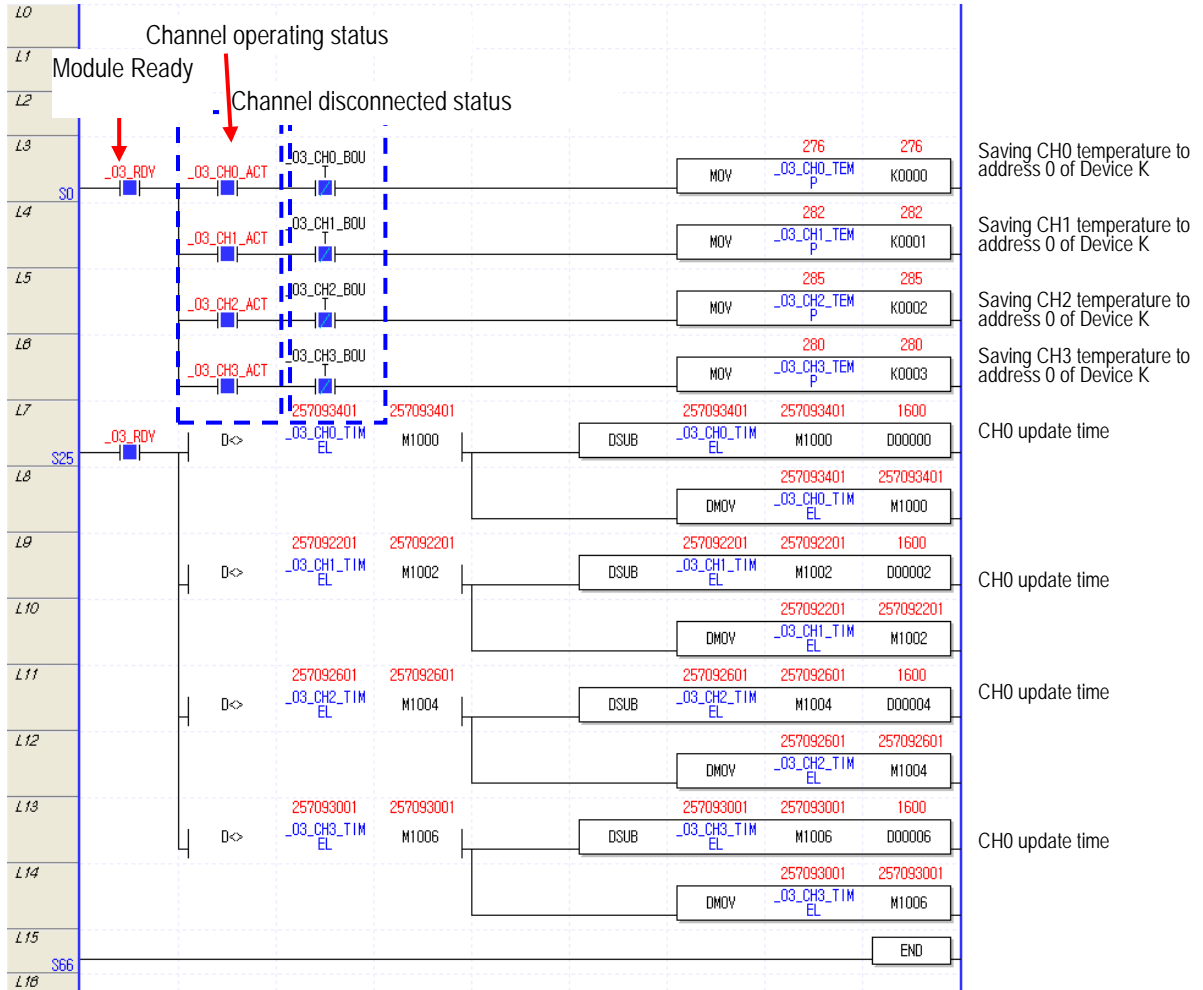

It delivers timer count by module's internal timer when it delivers temperature to PLC in module. If calculating the difference of the previous timer count (M1000/M1002/M1004/M1006) and the current timer counter, the value calculated is the interval at which module delivers data to PLC (here, the interval delivered by module is conversion velocity).



## Chapter 7 Configuration and Function of Global Variable (For XGI/XGR)

### 7.1 Global Variable (Data area)

#### 7.1.1 Conversion data IO area configuration

Indicates conversion data IO area of thermocouple input module at [Table 7.1]

[Table 7. 1] Conversion data IO area

Global variable	Memory allocation	Contents	Read/Write
_xxyy_CH0_ADJERR	%UXxx.yy.0	CH0 offset/gain adjustment error	Read
_xxyy_CH1_ADJERR	%UXxx.yy.1	CH1 offset/gain adjustment error	
_xxyy_CH2_ADJERR	%UXxx.yy.2	CH2 offset/gain adjustment error	
_xxyy_CH3_ADJERR	%UXxx.yy.3	CH3 offset/gain adjustment error	
_xxyy_WDT_ERR	%UXxx.yy.14	Module H/W error	
_xxyy_RDY	%UXxx.yy.15	Module Ready	
_xxyy_CH0_ACT	%UXxx.yy.16	CH0 Running	Read
_xxyy_CH1_ACT	%UXxx.yy.17	CH1 Running	
_xxyy_CH2_ACT	%UXxx.yy.18	CH2 Running	
_xxyy_CH3_ACT	%UXxx.yy.19	CH3 Running	
_xxyy_CH0_BOUT	%UXxx.yy.20	CH0 disconnection	
_xxyy_CH1_BOUT	%UXxx.yy.21	CH1 disconnection	
_xxyy_CH2_BOUT	%UXxx.yy.22	CH2 disconnection	
_xxyy_CH3_BOUT	%UXxx.yy.23	CH3 disconnection	
_xxyy_CH0_SETERR	%UXxx.yy.24	CH0 setting error	
_xxyy_CH1_SETERR	%UXxx.yy.25	CH1 setting error	
_xxyy_CH2_SETERR	%UXxx.yy.26	CH2 setting error	
_xxyy_CH3_SETERR	%UXxx.yy.27	CH3 setting error	
_xxyy_CH0_PALL	%UXxx.yy.32	CH0 process alarm L-L limit flag	
_xxyy_CH0_PAL	%UXxx.yy.33	CH0 process alarm L limit flag	
_xxyy_CH0_PAH	%UXxx.yy.34	CH0 process alarm H limit flag	
_xxyy_CH0_PAHH	%UWxx.yy.35	CH0 process alarm H-H limit flag	
_xxyy_CH1_PALL	%UWxx.yy.36	CH1 process alarm L-L limit flag	
_xxyy_CH1_PAL	%UWxx.yy.37	CH1 process alarm L limit flag	
_xxyy_CH1_PAH	%UWxx.yy.38	CH1 process alarm H limit flag	
_xxyy_CH1_PAHH	%UWxx.yy.39	CH1 process alarm H-H limit flag	
_xxyy_CH2_PALL	%UWxx.yy.40	CH2 process alarm L-L limit flag	
_xxyy_CH2_PAL	%UWxx.yy.41	CH2 process alarm L limit flag	
_xxyy_CH2_PAH	%UWxx.yy.42	CH2 process alarm H limit flag	
_xxyy_CH2_PAHH	%UWxx.yy.43	CH2 process alarm H-H limit flag	
_xxyy_CH3_PALL	%UWxx.yy.44	CH3 process alarm L-L limit flag	
_xxyy_CH3_PAL	%UWxx.yy.45	CH3 process alarm L limit flag	
_xxyy_CH31_PAH	%UWxx.yy.46	CH3 process alarm H limit flag	
_xxyy_CH3_PAHH	%UWxx.yy.47	CH3 process alarm H-H limit flag	

Global variable	Memory allocation	Contents	Read/Write
_xxyy_CH0_RAL	%UXxx.yy.48	CH0 rate-change alarm L limit flag	Read
_xxyy_CH0_RAH	%UXxx.yy.49	CH0 rate-change alarm H limit flag	Read
_xxyy_CH1_RAL	%UXxx.yy.52	CH1 rate-change alarm L limit flag	
_xxyy_CH1_RAH	%UXxx.yy.53	CH1 rate-change alarm H limit flag	
_xxyy_CH2_RAL	%UXxx.yy.56	CH2 rate-change alarm L limit flag	
_xxyy_CH2_RAH	%UXxx.yy.57	CH2 rate-change alarm H limit flag	
_xxyy_CH3_RAL	%UXxx.yy.60	CH3 rate-change alarm L limit flag	
_xxyy_CH3_RAH	%UXxx.yy.61	CH3 rate-change alarm H limit flag	
_xxyy_CH0_TEMP	%UWxx.yy.4	CH0 temp. conversion value	
_xxyy_CH1_TEMP	%UWxx.yy.5	CH1 temp. conversion value	Read
_xxyy_CH2_TEMP	%UWxx.yy.6	CH2 temp. conversion value	Read
_xxyy_CH3_TEMP	%UWxx.yy.7	CH3 temp. conversion value	Read
_xxyy_CH0_SCAL	%UWxx.yy.8	CH0 scaling operation value	Read
_xxyy_CH1_SCAL	%UWxx.yy.9	CH1 scaling operation value	Read
_xxyy_CH2_SCAL	%UWxx.yy.10	CH2 scaling operation value	Read
_xxyy_CH3_SCAL	%UWxx.yy.11	CH3 scaling operation value	Read
_xxyy_CH0_MIN	%UWxx.yy.12	CH0 temp. conversion min. value	Read
_xxyy_CH0_MAX	%UWxx.yy.13	CH0 temp. conversion max. value	Read
_xxyy_CH1_MIN	%UWxx.yy.14	CH1 temp. conversion min. value	Read
_xxyy_CH1_MAX	%UWxx.yy.15	CH1 temp. conversion max. value	Read
_xxyy_CH2_MIN	%UWxx.yy.16	CH2 temp. conversion min. value	Read
_xxyy_CH2_MAX	%UWxx.yy.17	CH2 temp. conversion max. value	Read
_xxyy_CH3_MIN	%UWxx.yy.18	CH3 temp. conversion min. value	Read
_xxyy_CH3_MAX	%UWxx.yy.19	CH3 temp. conversion max. value	Read
_xxyy_CH0_TIME	%UDxx.yy.10	CH0 data upload time	Read
_xxyy_CH1_TIME	%UDxx.yy.11	CH1 data upload time	Read
_xxyy_CH2_TIME	%UDxx.yy.12	CH2 data upload time	Read
_xxyy_CH3_TIME	%UDxx.yy.13	CH3 data upload time	Read

[Table 7. 2] Command sent to XGI/XGR PLC (XGI/XGR PLC output area)

Global variable	Memory allocation	Contents	Read/Write
_xxyy_CH0_FINDEN	%UXxx.yy.464	CH0 Max/Min search Enable/Disable	Read /Write
_xxyy_CH1_FINDEN	%UXxx.yy.465	CH1 Max/Min search Enable/Disable	
_xxyy_CH2_FINDEN	%UXxx.yy.466	CH2 Max/Min search Enable/Disable	
_xxyy_CH3_FINDEN	%UXxx.yy.467	CH3 Max/Min search Enable/Disable	
_xxyy_CH0_ALMEN	%UXxx.yy.468	CH0 Alarm (Progress alarm/Gradient alarm) Enable/Disable	
_xxyy_CH1_ALMEN	%UXxx.yy.469	CH1 Alarm (Progress alarm/Gradient alarm) Enable/Disable	
_xxyy_CH2_ALMEN	%UXxx.yy.470	CH2 Alarm (Progress alarm/Gradient alarm) Enable/Disable	
_xxyy_CH3_ALMEN	%UXxx.yy.471	CH3 Alarm (Progress alarm/Gradient alarm) Enable/Disable	
_xxyy_CH0_RJCDS	%UXxx.yy.472	CH0 Cold junction compensating function Disable/Enable	
_xxyy_CH1_RJCDS	%UXxx.yy.473	CH1 Cold junction compensating function Disable/Enable	
_xxyy_CH2_RJCDS	%UXxx.yy.474	CH2 Cold junction compensating function Disable/Enable	
_xxyy_CH3_RJCDS	%UXxx.yy.475	CH3 Cold junction compensating function Disable/Enable	

※ At the device allocation, xx means base number and yy means slot number where module is installed

### 7.1.2 How to use global variable

- In order to register global variable, there are two method, auto registration after setting I/O parameter at project window and batch registration after setting I/O parameter

1) I/O parameter registration

- Registers module you want to use at I/O parameter

(1) Double-click I/O parameter of project window

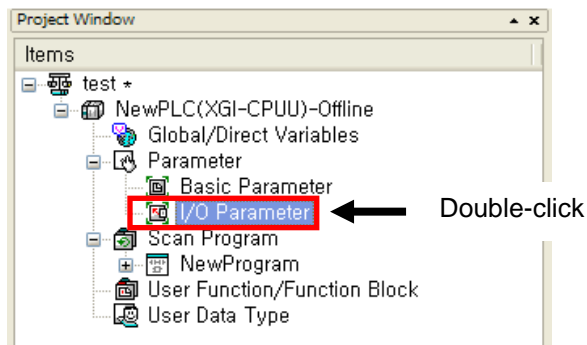

(2) Select XGF-TC4S module at I/O parameter window

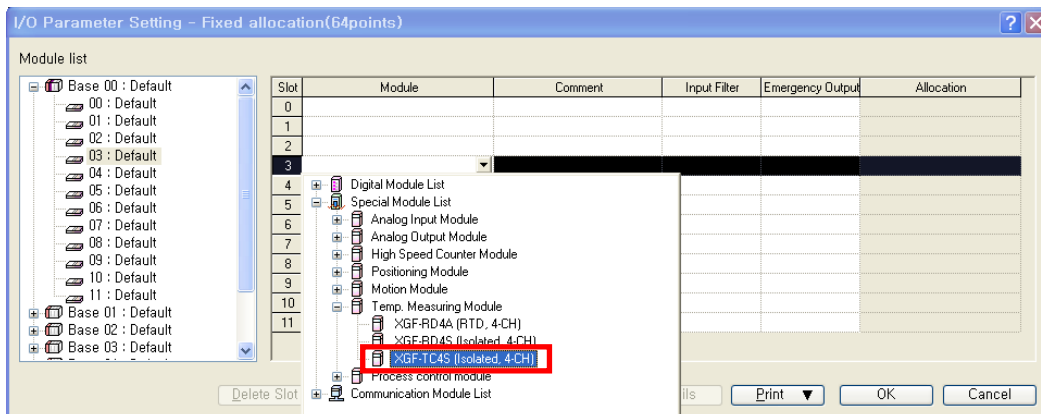

(3) Set parameter by pressing [Details]

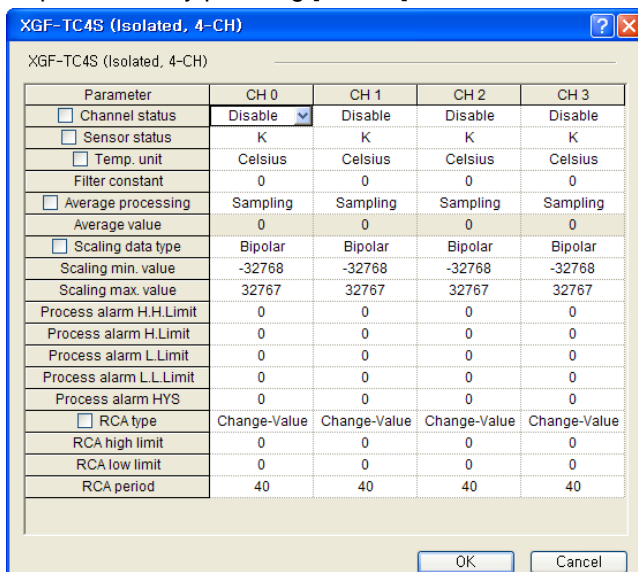

(4) Select [Yes]

- Register global variable of module set in I/O parameter automatically.

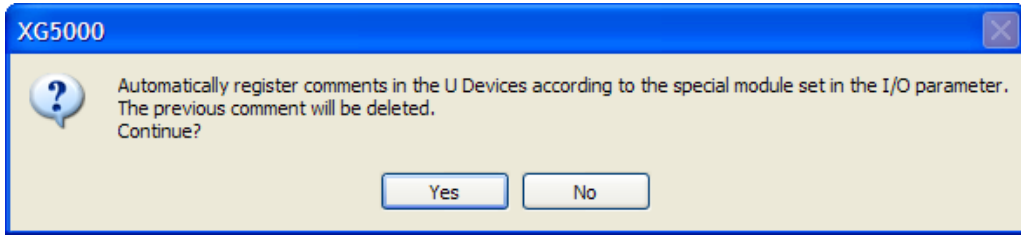

(5) Global variable auto registration check

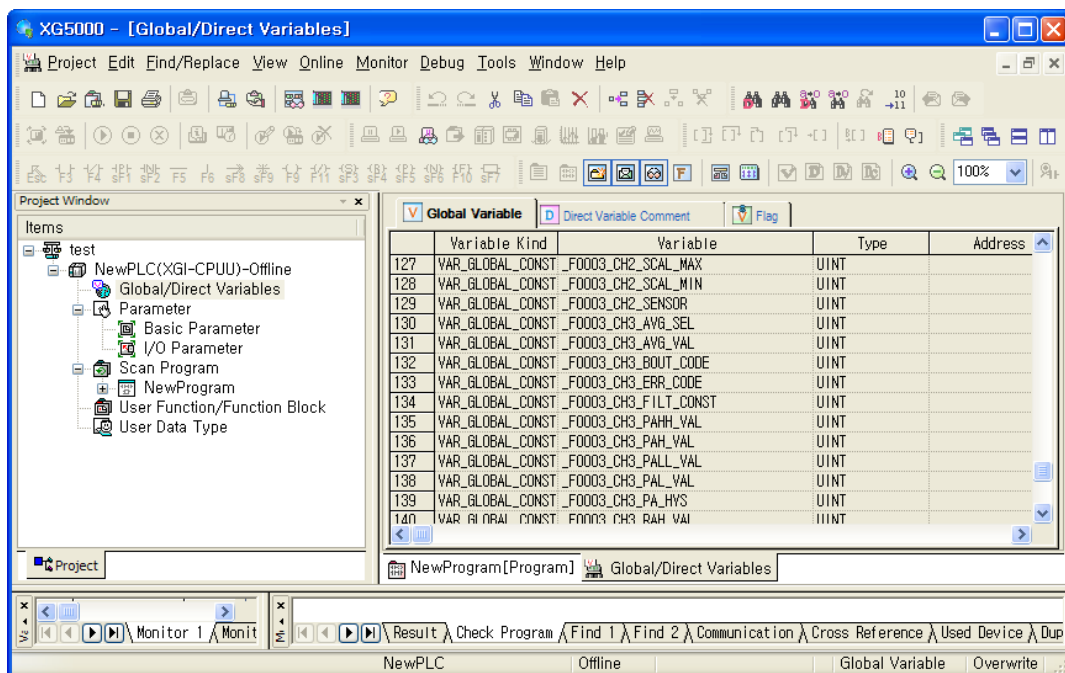
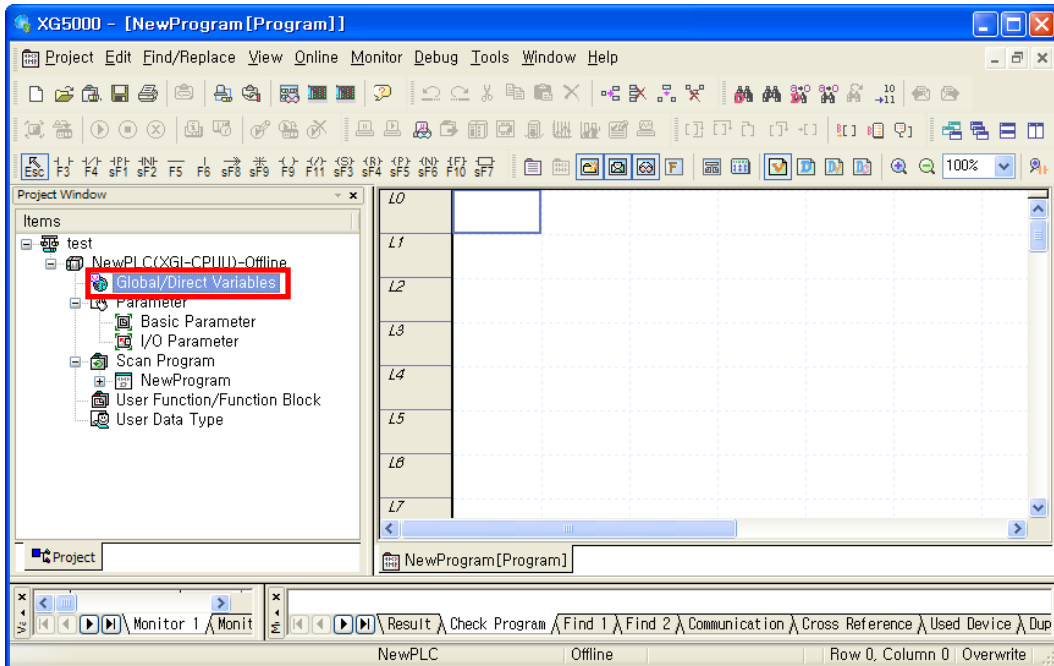



## 2) Global variable batch registration

- Registers global variable of module set in I/O parameter automatically

### (1) Double-click Global/Direct Variable of project window

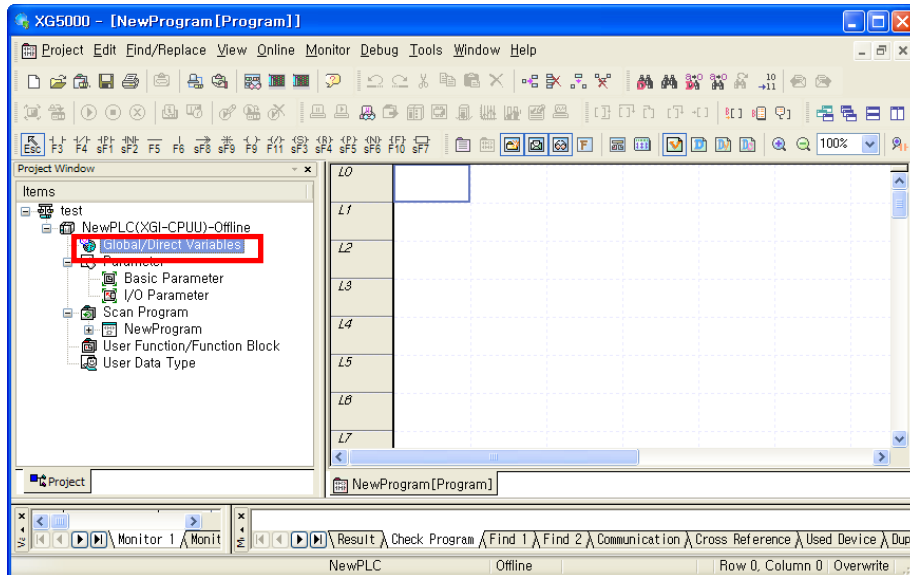

### (2) Select [Register Special Module Variables] at menu [Edit]

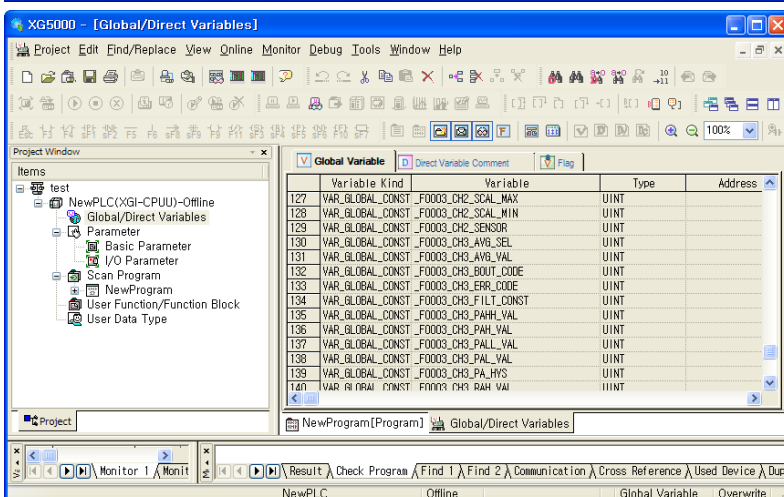
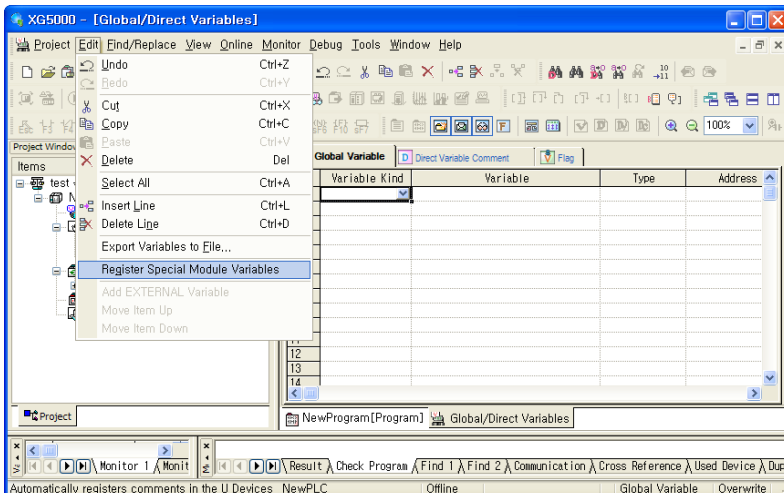

### 3) Local variable registration

- Registers variable among registered global variable you want to use as local variable.

(1) Double-click local variable to use in the following scan program.

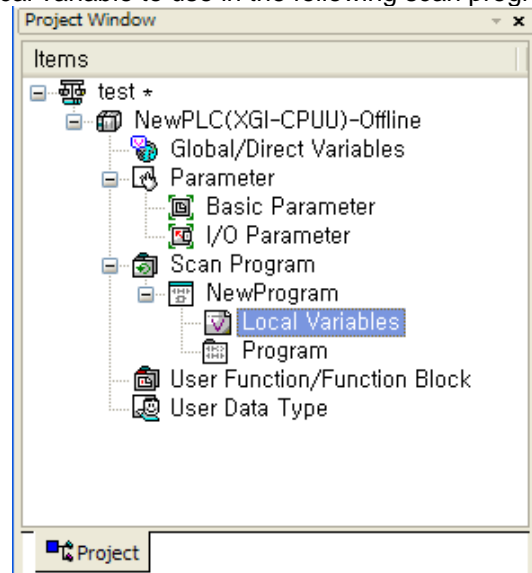

(2) Click right button of mouse in the right local variable window and select "Add EXTERNAL variable".

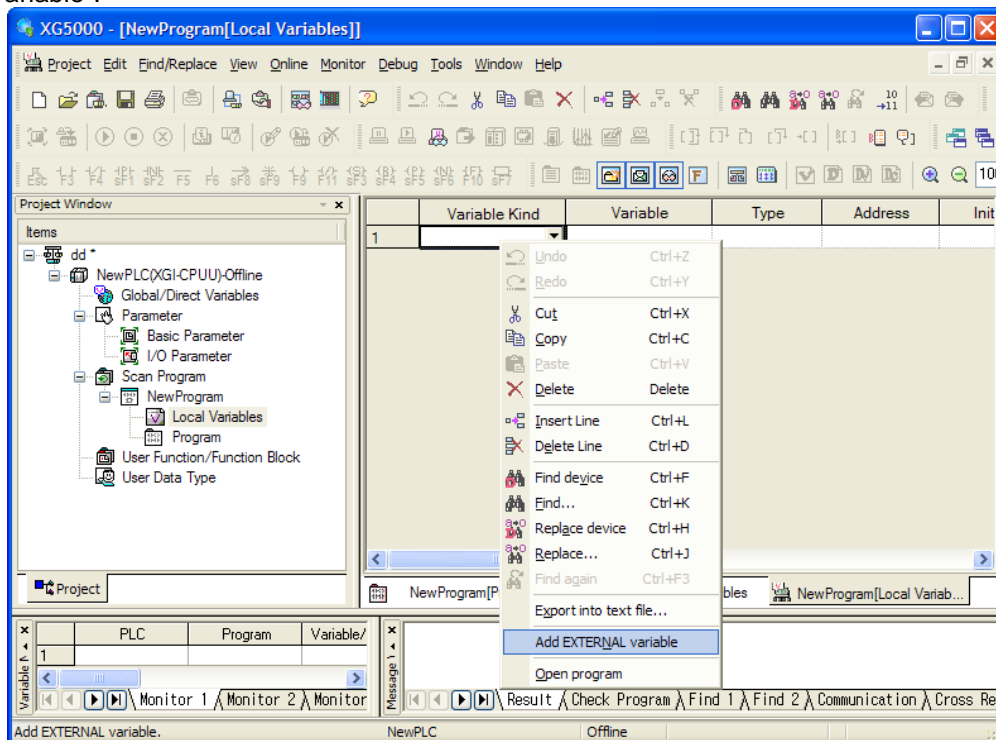

- (3) Select local variable to add at Global View on “Add External Variable” window (“All” or “Base, slot”).

-View All

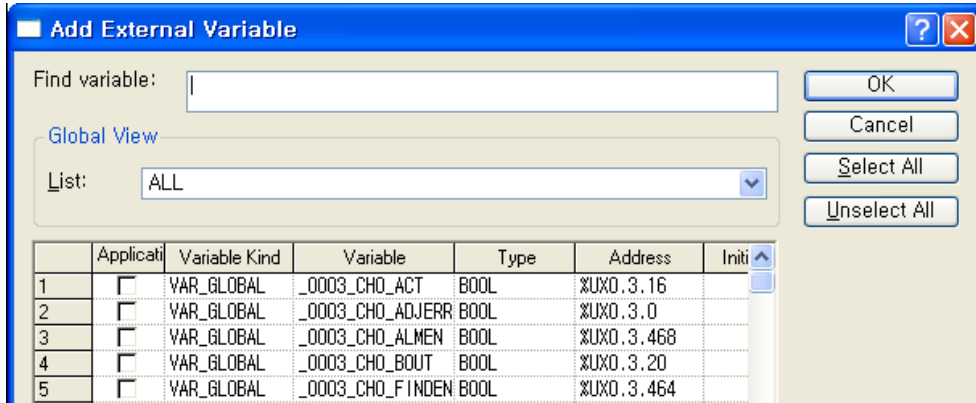

- View per base, slot

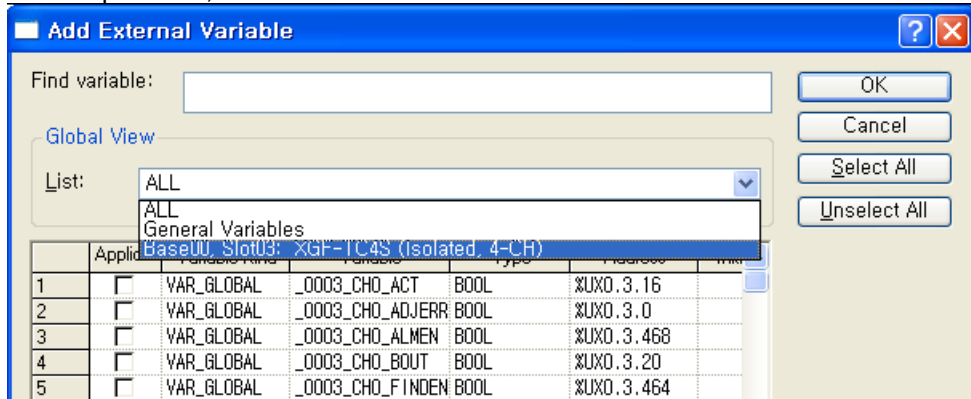

- (4) The following is example selecting CH0 temp. conversion value (\_0003\_CHO\_TEMP) of “Base00, Slot03”.

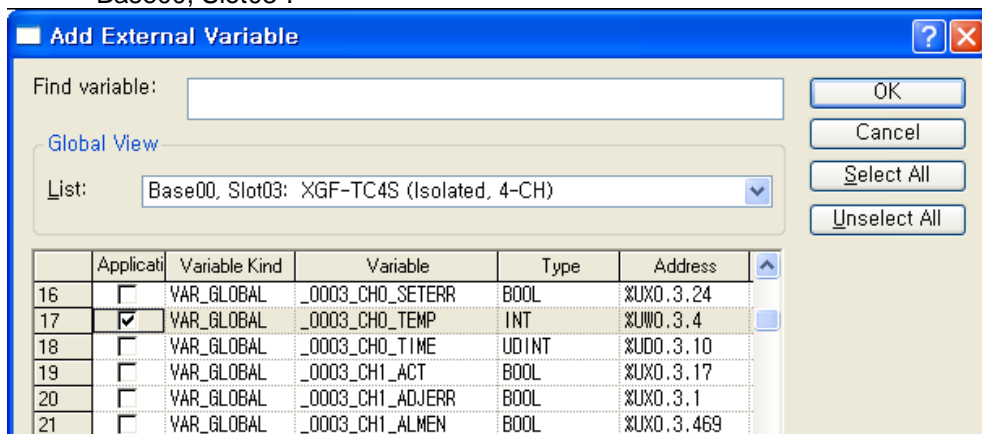

4) How to use local variable on program

- It describes the added global variable at local program.
- The following is example getting the conversion value of CH0 of A/D conversion module to %MW0.

(1) At part reading A/D conversion data to %MW0 by using the following MOVE function, double-click variable part ahead of IN, then "Select Variable" window shows up.

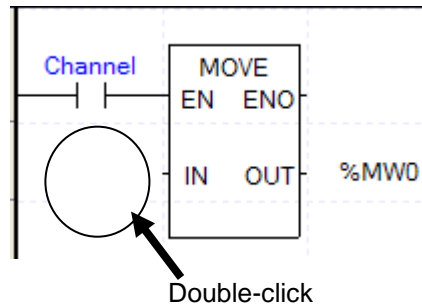

(2) Select global variable at variable type at Select Variable window. And select relevant base (0 base, 3 slot) at global variable view item.

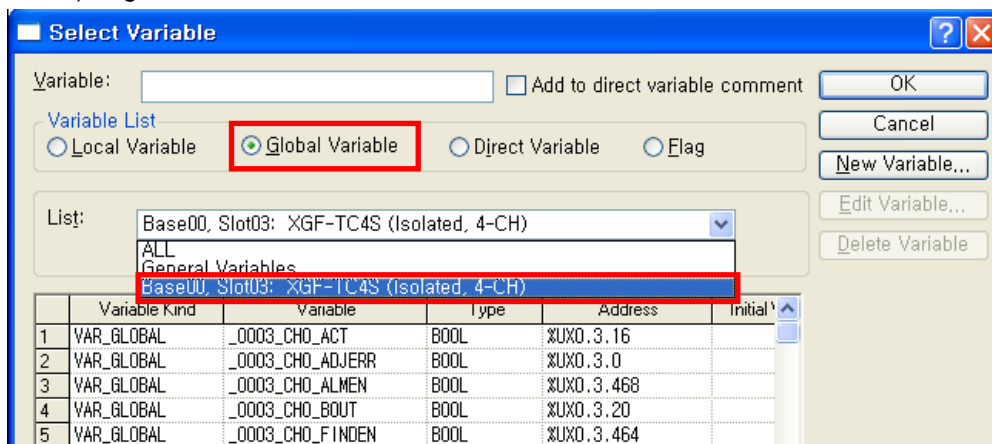

(3) Double-click or select `_0003_CH0_TEMP` corresponding to CH0 temp. conversion data and click [OK].

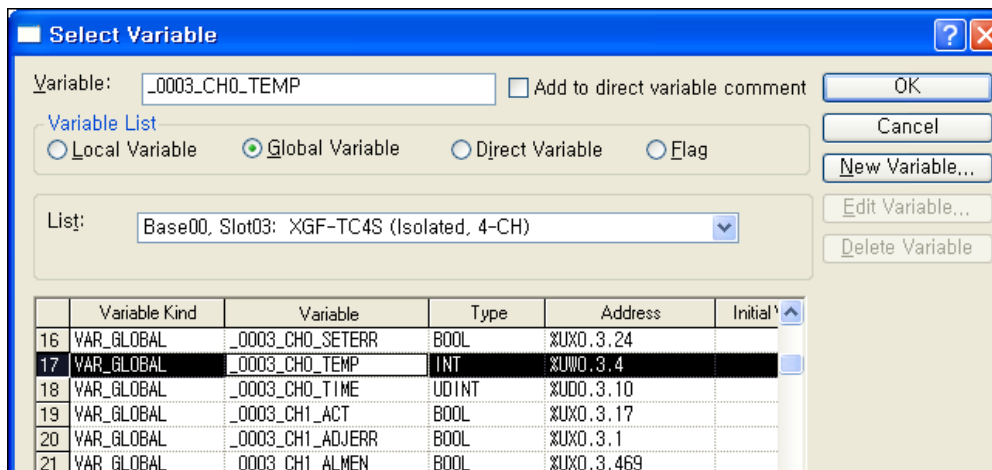

(4) The following figure is result adding global variable corresponding to CH0 temp. conversion value.

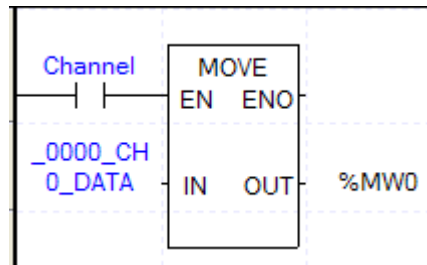

## 7.2 PUT/GET Function Block use area (Parameter area)

### 7.2.1 PUT/GET Function Block use area (Parameter area)

It indicates operation parameter setting area of D/A conversion module at table 7.2.

[Table 7. 2] Operation parameter setting area

Global variable	Details	Read/Write	instruction
_Fxyy_CH_EN	Channel Enable/Disable setting	Read/Write	PUT/GET
_Fxyy_CH0_SENSOR	CH0 sensor type setting	Read/Write	PUT/GET
_Fxyy_CH1_SENSOR	CH1 sensor type setting		
_Fxyy_CH2_SENSOR	CH2 sensor type setting		
_Fxyy_CH3_SENSOR	CH3 sensor type setting		
_Fxyy_DATA_TYPE	Temp. unit setting	Read/Write	PUT/GET
_Fxyy_CH0_FILT_CONST	CH0 filter value setting	Read/Write	PUT/GET
_Fxyy_CH1_FILT_CONST	CH1 filter value setting		
_Fxyy_CH2_FILT_CONST	CH2 filter value setting		
_Fxyy_CH3_FILT_CONST	CH3 filter value setting		
_Fxyy_CH0_AVG_SEL	CH0 average method setting	Read/Write	PUT/GET
_Fxyy_CH1_AVG_SEL	CH1 average method setting		
_Fxyy_CH2_AVG_SEL	CH2 average method setting		
_Fxyy_CH3_AVG_SEL	CH3 average method setting		
_Fxyy_CH0_AVG_VAL	CH0 average value setting	Read/Write	PUT/GET
_Fxyy_CH1_AVG_VAL	CH1 average value setting		
_Fxyy_CH2_AVG_VAL	CH2 average value setting		
_Fxyy_CH3_AVG_VAL	CH3 average value setting		
_Fxyy_SCAL_SIGN	Scaling type setting	Read/Write	PUT/GET
_Fxyy_CH0_SCAL_MIN	CH0 scaling range min. value setting	-32768	PUT/GET
_Fxyy_CH0_SCAL_MAX	CH0 scaling range max. value setting	32767	
_Fxyy_CH1_SCAL_MIN	CH1 scaling range min. value setting	-32768	
_Fxyy_CH1_SCAL_MAX	CH1 scaling range max. value setting	32767	
_Fxyy_CH2_SCAL_MIN	CH2 scaling range min. value setting	-32768	
_Fxyy_CH2_SCAL_MAX	CH2 scaling range max. value setting	32767	
_Fxyy_CH3_SCAL_MIN	CH3 scaling range min. value setting	-32768	
_Fxyy_CH3_SCAL_MAX	CH3 scaling range max. value setting	32767	

※ At the device allocation, xx means base number and yy means slot number where module is installed

Global variable	Details	Read/Write	instruction
_Fxyy_CH0_PAHH_VAL	CH 0 process alarm H.H.	Read/Write	PUT/GET
_Fxyy_CH0_PAH_VAL	CH 0 process alarm H.		
_Fxyy_CH0_PAL_VAL	CH 0 process alarm L.		
_Fxyy_CH0_PALL_VAL	CH 0 process alarm L.L.		
_Fxyy_CH1_PAHH_VAL	CH 1 process alarm H.H.		
_Fxyy_CH1_PAH_VAL	CH 1 process alarm H.		
_Fxyy_CH1_PAL_VAL	CH 1 process alarm L.		
_Fxyy_CH1_PALL_VAL	CH 1 process alarm L.L.		
_Fxyy_CH2_PAHH_VAL	CH 2 process alarm H.H.		
_Fxyy_CH2_PAH_VAL	CH 2 process alarm H.		
_Fxyy_CH2_PAL_VAL	CH 2 process alarm L.		
_Fxyy_CH2_PALL_VAL	CH 2 process alarm L.L.		
_Fxyy_CH3_PAHH_VAL	CH 3 process alarm H.H.		
_Fxyy_CH3_PAH_VAL	CH 3 process alarm H.		
_Fxyy_CH3_PAL_VAL	CH 3 process alarm L.		
_Fxyy_CH3_PALL_VAL	CH 3 process alarm L.L.		
_Fxyy_CH0_PA_HYS	CH 0 process alarm hysteresis	Read/Write	PUT/GET
_Fxyy_CH1_PA_HYS	CH 1 process alarm hysteresis		
_Fxyy_CH2_PA_HYS	CH 2 process alarm hysteresis		
_Fxyy_CH3_PA_HYS	CH 3 process alarm hysteresis		
_Fxyy_RA_TYPE	Type of gradient alarm value setting	Read/Write	PUT/GET
_Fxyy_CH0_RAH_VAL	CH 0 gradient alarm H.	Read/Write	PUT/GET
_Fxyy_CH0_RAL_VAL	CH 0 gradient alarm L.		
_Fxyy_CH1_RAH_VAL	CH 1 gradient alarm H.		
_Fxyy_CH1_RAL_VAL	CH 1 gradient alarm L.		
_Fxyy_CH2_RAH_VAL	CH 2 gradient alarm H.		
_Fxyy_CH2_RAL_VAL	CH 2 gradient alarm L.		
_Fxyy_CH3_RAH_VAL	CH 3 gradient alarm H.		
_Fxyy_CH3_RAL_VAL	CH 3 gradient alarm L.		
_Fxyy_CH0_RA_PERIOD	CH 0 gradient alarm detection period	Read/Write	PUT/GET
_Fxyy_CH1_RA_PERIOD	CH 1 gradient alarm detection period		
_Fxyy_CH2_RA_PERIOD	CH 2 gradient alarm detection period		
_Fxyy_CH3_RA_PERIOD	CH 3 gradient alarm detection period		

**7.2.2 Other data monitor area (Using GET/GETP)**

Global variable	Details	Read/Write	instruction
_Fxyy_CH0_ERR_CODE	CH0 setting error information (flag)	Read	GET
_Fxyy_CH1_ERR_CODE	CH1 setting error information (flag)		
_Fxyy_CH2_ERR_CODE	CH2 setting error information (flag)		
_Fxyy_CH3_ERR_CODE	CH3 setting error information (flag)		
_Fxyy_CH0_RAVAL	CH0 rate of change alarm value	Read	GET
_Fxyy_CH1_RAVAL	CH1 rate of change alarm value		
_Fxyy_CH2_RAVAL	CH2 rate of change alarm value		
_Fxyy_CH3_RAVAL	CH3 rate of change alarm value		
_Fxyy_CH0_BOUT_CODE	CH0 disconnection information (code)	Read	GET
_Fxyy_CH1_BOUT_CODE	CH1 disconnection information (code)		
_Fxyy_CH2_BOUT_CODE	CH2 disconnection information (code)		
_Fxyy_CH3_BOUT_CODE	CH3 disconnection information (code)		
_Fxyy_CH0_RJC	CH0 cold junction compensation temp.	Read	GET
_Fxyy_CH1_RJC	CH1 cold junction compensation temp.		
_Fxyy_CH2_RJC	CH2 cold junction compensation temp.		
_Fxyy_CH3_RJC	CH3 cold junction compensation temp.		



### 7.2.3 PUT/GET instruction

(1) PUT instruction

<b>PUT</b>
Writing data to special module

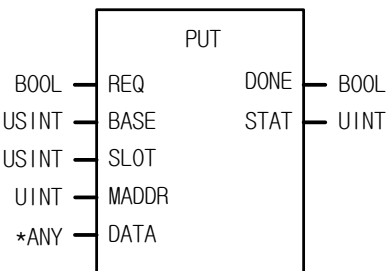
Function Block	Description
	<p><b>Input</b></p> <p>REQ : execute function when 1            BASE : set base position            SLOT : set slot position            MADDR : module address            DATA : data to save module</p> <p><b>Output</b></p> <p>DONE : Output 1 when normal            STAT : Error information</p>

\*ANY: WORD, DWORD, INT, USINT, DINT, UDINT type available among ANY type

■ **Function**

Read data from designated special module

Function Block	Input(ANY) type	Description
PUT_WORD	WORD	Save WRD data into the designated module address (MADDR).
PUT_DWORD	DWORD	Save DWORD data into the designated module address (MADDR).
PUT_INT	INT	Save INT data into the designated module address (MADDR).
PUT_UINT	UINT	Save UNIT data into the designated module address (MADDR).
PUT_DINT	DINT	Save DINT data into the designated module address (MADDR).
PUT_UDINT	UDINT	Save UDINT data into the designated module address (MADDR).

(2) GET instruction

<b>GET</b>
Reading from special module data

Function block	Description
<pre> graph LR     subgraph GET         REQ[REQ]         BASE[BASE]         SLOT[SLOT]         MADDR[MADDR]         DONE[DONE]         STAT[STAT]         DATA[DATA]     end     REQ --- DONE     BASE --- STAT     SLOT --- DATA     MADDR --- DATA             </pre>	<p><b>Input</b></p> <p>REQ : execute function when 1                  BASE : set base position                  SLOT : set slot position                  MADDR : module address                  512(0x200) ~ 1023(0x3FF)</p> <p><b>Output</b></p> <p>DONE : output 1 when normal                  STAT : Error information                  DATA : data to read from module</p>

\*ANY: WORD, DWORD, INT, UINT, DINT, UDINT type available among ANY type

■ **Function**

Read data from designated special module

Function Block	Output(ANY) type	Description
GET_WORD	WORD	Read data as much as WORD from the designated module address (MADDR).
GET_DWORD	DWORD	Read data as much as DWORD from the designated module address (MADDR).
GET_INT	INT	Read data as much as INT from the designated Module address (MADDR).
GET_UINT	UINT	Read data as much as UNIT from the designated module address (MADDR).
GET_DINT	DINT	Read data as much as DINT from the designated module address (MADDR).
GET_UDINT	UDINT	Read data as much as UDINT from the designated module address (MADDR).

**7.2.4 Example using PUT/GET instruction**

1) Enable channel

- (1) You can enable/disable temp. conversion per channel
- (2) Disable the channel not used to reduce the conversion cycle per channel
- (3) When channel is not designated, all channels are set as not used
- (4) Enable/disable of temp. conversion is as follows

B15	B14	B13	B12	B11	B10	B9	B8	B7	B6	B5	B4	B3	B2	B1	B0
C	C	C	C	C	C	C	C	C	C	C	C	C	C	C	C
H	H	H	H	H	H	H	H	H	H	H	H	H	H	H	H
15	14	13	12	11	10	9	8	7	6	5	4	3	2	1	0

Bit	Description
0	Stop
1	Run

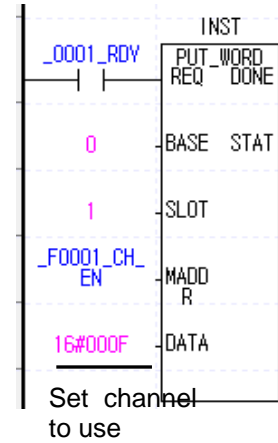
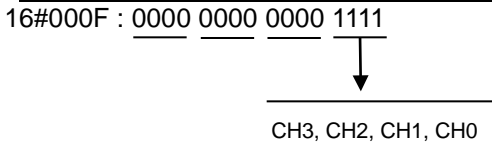

- (5) The value in B4~B15 is ignored.
- (6) The right figure is example enabling CH0~CH3 of module equipped at slot 1.

2) Sensor type setting

- (1) Sets sensor type
- (2) When there's input larger than 3, setting error is indicated and value is set as "0" regardless of previous value.

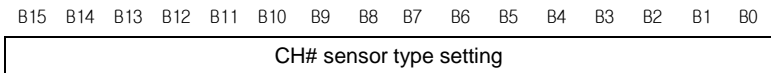

Word value	Details	Ref.
0	K type	
1	J type	
2	E type	
3	T type	
4	B type	
5	R type	
6	S type	
7	N type	
8	C type	

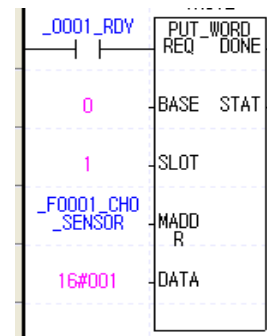

3) Temperature display unit setting

(1) You can specify the temperature display unit (Celsius/Fahrenheit)

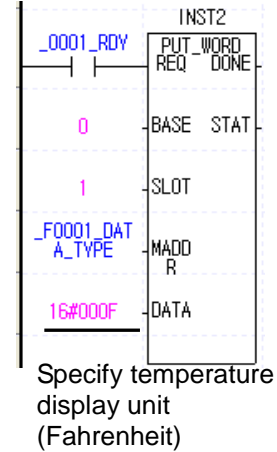
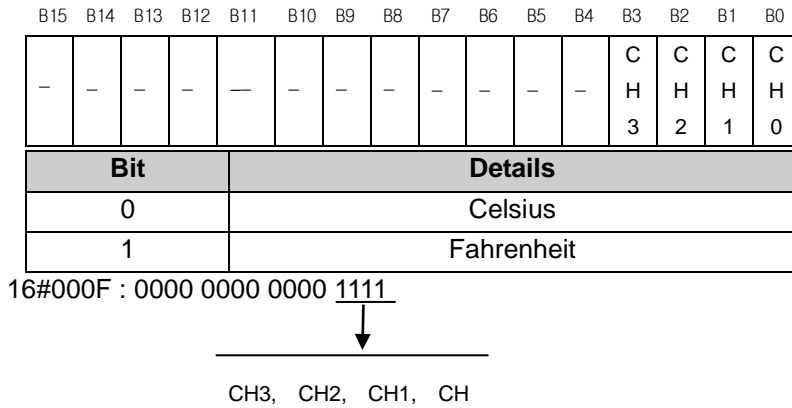

- (2) Values set in B4~B15 are ignored.
- (3) Right figure is example specifying temperature display unit of CH0~CH3 as Fahrenheit.

4) Average process method setting

(1) When there's input larger than 3, setting error is indicated and value is set as "0" regardless of previous value.

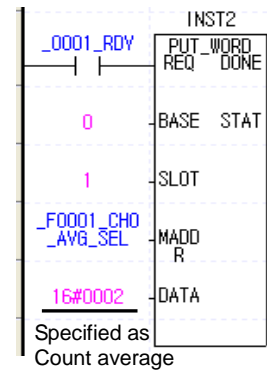
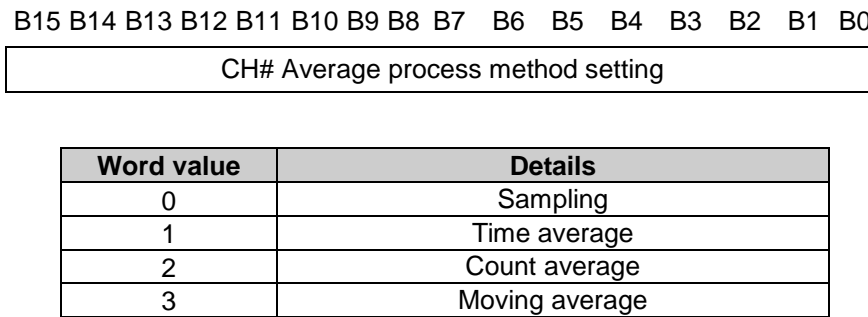

5) Average value setting

- (1) When Average process method is Sampling, this area is ignored.
- (2) When it's set out of range, setting error occurs and average value is set as Max or Min value.

EX) When you set Average process method as Time average and input 200, setting error occurs and that is set as 320 internally.

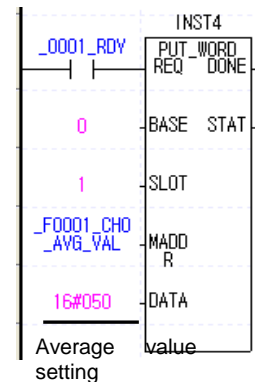
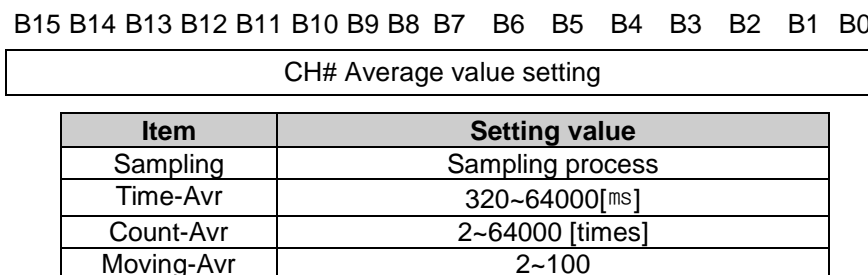

6) Scaling type setting

- (1) When it is set as "1", scaling min/max value is specified as unsigned integer. Maximum range of output data by scaling operation is "0~65535".
- (2) When it is set as "0", scaling min/max value is specified as signed integer. Maximum range of output data by scaling operation is "-32768~32767".

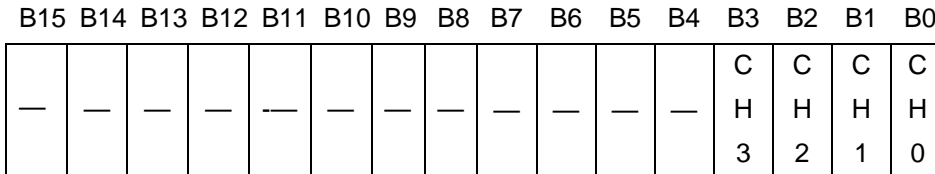

Bit	Details
0	Signed integer
1	Unsigned integer

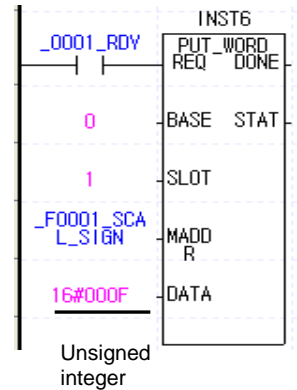
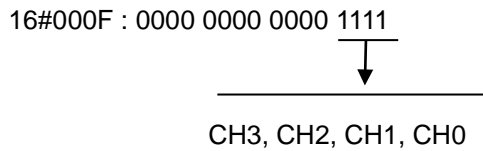

7) Scaling max./min. value setting

- (1) If it is set out of range, setting value is latched as previous value saved in module

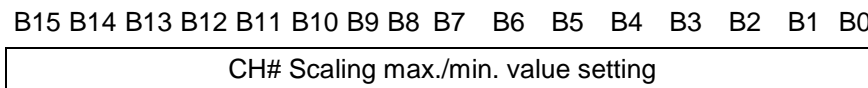

Item	Setting value
Signed integer	-32,768 ~ 32,767
Unsigned integer	0 ~ 65535

Scaling max. value setting

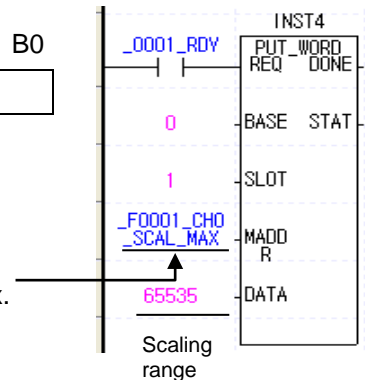

8) Process alarm boundary setting

- (1) Setting range is different according to temperature unit and sensor type
- (2) If it is set out of range, setting error occurs and setting value is latched as previous value saved in module

B15 B14 B13 B12 B11 B10 B9 B8 B7 B6 B5 B4 B3 B2 B1 B0  
 CH# process alarm boundary setting

Item	Setting value
`K	-250 ~ 1350°C
J	-200 ~ 1200°C
E	-250 ~ 1000°C
T	-250 ~ 400°C
B	400 ~ 1800°C
R	-50 ~ 1750°C
S	-50 ~ 1750°C
N	-270 ~ 1300°C
C	0 ~ 2300°C

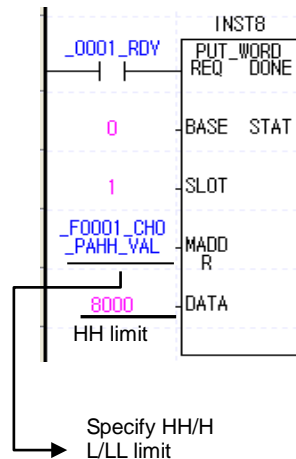

9) Process alarm hysteresis setting

- (1) If it is set out of range, setting error occurs and setting value is set as 0 regardless of previous value
- (2) When using process alarm function, though it exceeds the alarm condition, if it is within hysteresis value, alarm output is latched

B15 B14 B13 B12 B11 B10 B9 B8 B7 B6 B5 B4 B3 B2 B1 B0  
 CH# alarm hysteresis setting

Setting value
0 ~ 1000

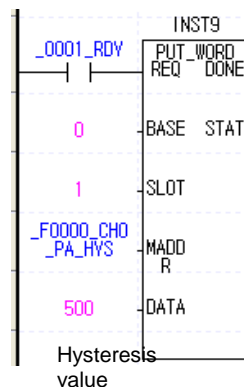

10) Rate-change alarm type setting

- (1) When it is set as "1", Change-Rate is used as standard of Rate change alarm (RCA)
- (2) When it is set as "0", Change-Value is used as standard of Rate change alarm (RCA)
- (3) Information in Bit 4~F is ignored.

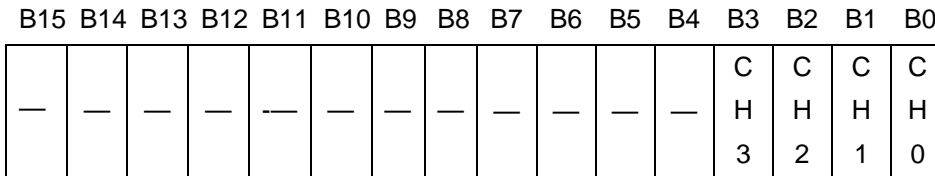

Bit	Details
0	Change-Value
1	Change-Rate

16#000F : 0000 0000 0000 1111  
 ↓  
 CH3, CH2, CH1, CH0

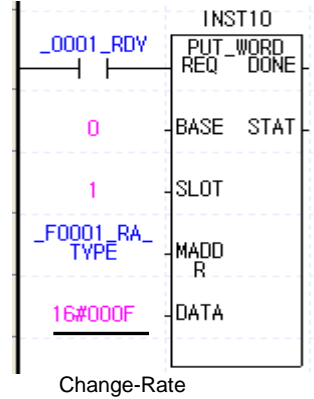

11) Rate-change alarm H/L limit setting

- (1) If it is set out of range, setting error occurs and setting value is set as 0 regardless of previous value
- (2) In case of Change-Rate, this value becomes percentile value indicating to first decimal point
- (3) In case of Change-Value, this value becomes temperature.

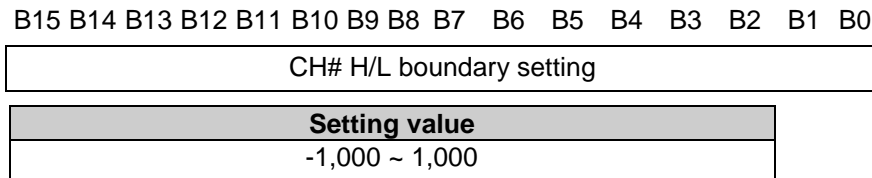

Specify H/L boundary

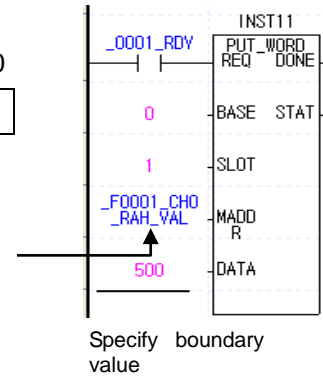

12) RCA (rate-change alarm) detection period setting

- (1) When using RCA function, here specifies period to detect change
- (2) If it is set out of range, setting error occurs and value is set as 40[ms]

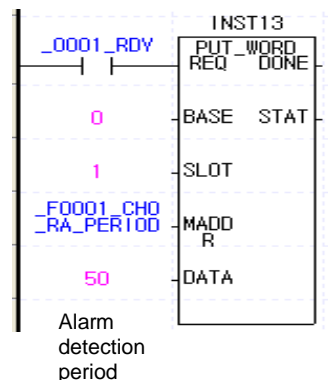
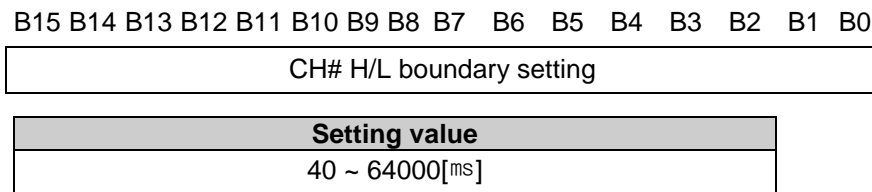

13) Channel error information output

- (1) If it is set out of range (in case of setting by program), relevant bit is set as “1”
- (2) Setting error is canceled when setting range is normal by re-setting
- (3) In case of setting error, LED doesn't change. In case Uxy.01.08~Uxy.01.0B is on, check the setting
- (4) Relevant setting address and details per each bit

Bit status	Details	Address
0	Sensor type setting error	1~4
1	Filter value setting error	6~9
2	Average process method setting error	10~13
3	Average value setting error	14~17
4	Scaling min. value setting error	19,21,23,25
5	Scaling max. value setting error	20,22,24,26
6	Process alarm HH limit setting error	27,31,35,39
7	Process alarm H limit setting error	28,32,36,40
8	Process alarm L limit setting error	29,33,37,41
9	Process alarm LL limit setting error	30,34,38,42
A	Process alarm hysteresis setting error	39~46
B	Rate change alarm H limit setting error	48,50,52,54
C	Rate change alarm L limit setting error	49,51,53,55
D	Rate change alarm detection period setting error	56~59

B15	B14	B13	B12	B11	B10	B9	B8	B7	B6	B5	B4	B3	B2	B1	B0
—	—	C	C	C	C	C	C	C	C	C	C	C	C	C	C
		H	H	H	H	H	H	H	H	H	H	H	H	H	H
		0	0	0	0	0	0	0	0	0	0	0	0	0	0

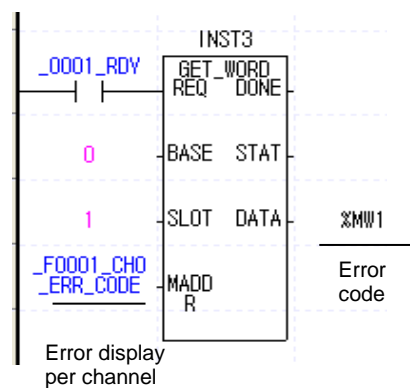



14) Rate change alarm conversion value output

(1) During detection period, it outputs change of input (temperature) or rate (% rate according to sensor range)

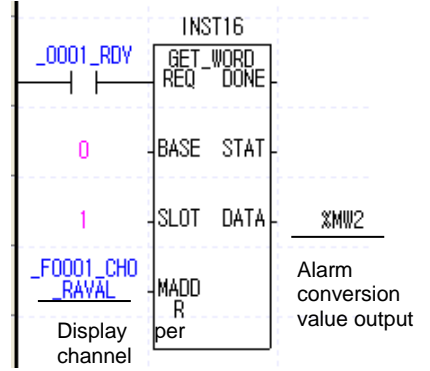
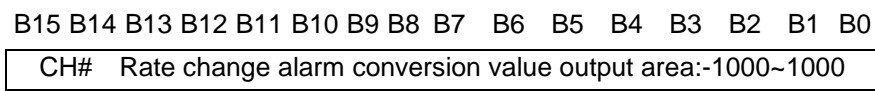

15) Sensor disconnection information output

(1) This is area to output disconnection information of each channel

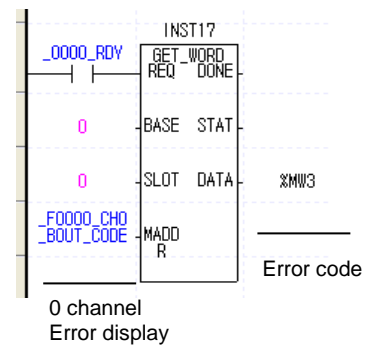
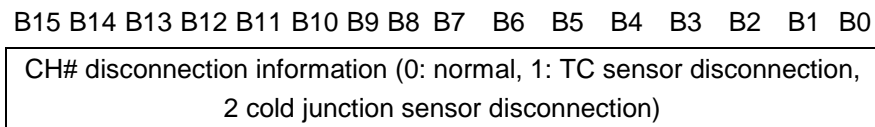

# Chapter 8 Programming (For XGI/XGR)

## 8.1 Basic Program

### 8.1.1 Program to sort A/D converted value in size

- Read temperature value by external contact point.
- In case temperature exceeds some range, program turns on contact point.

#### 1) System configuration

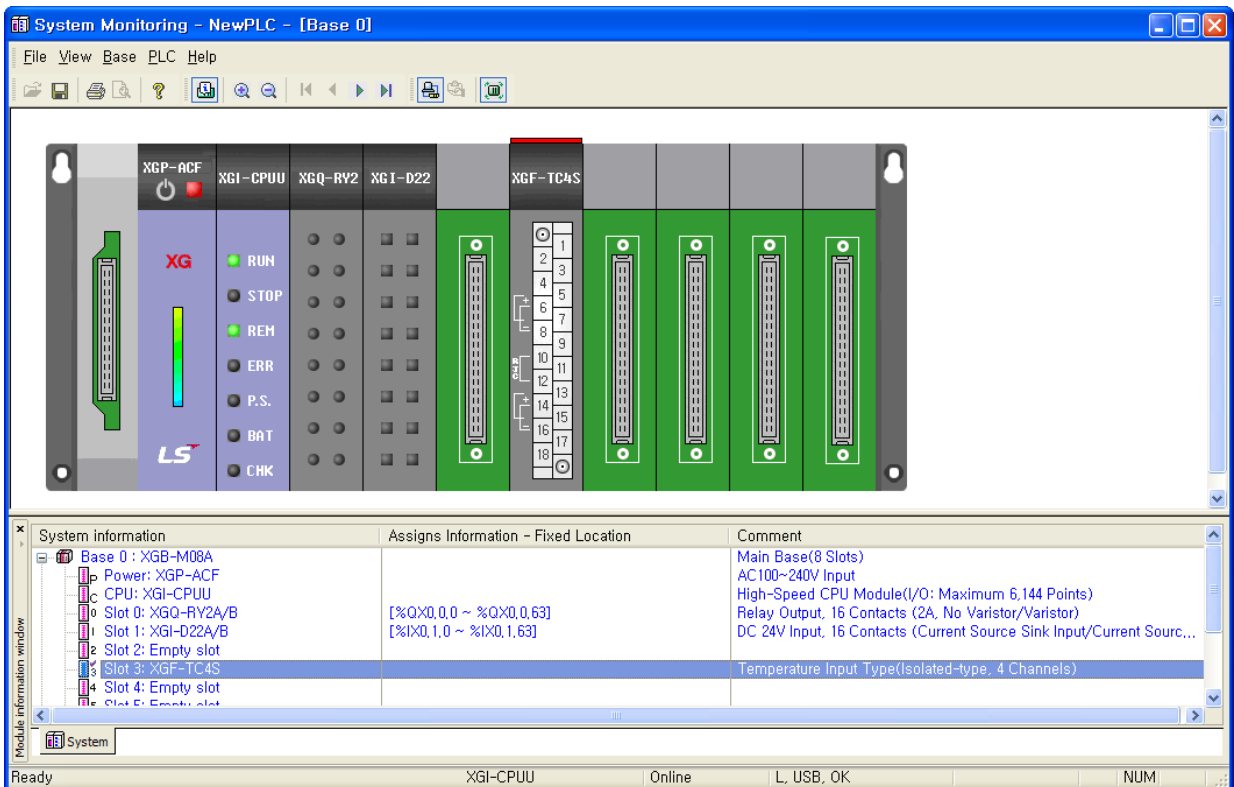

#### 2) Parameter setting

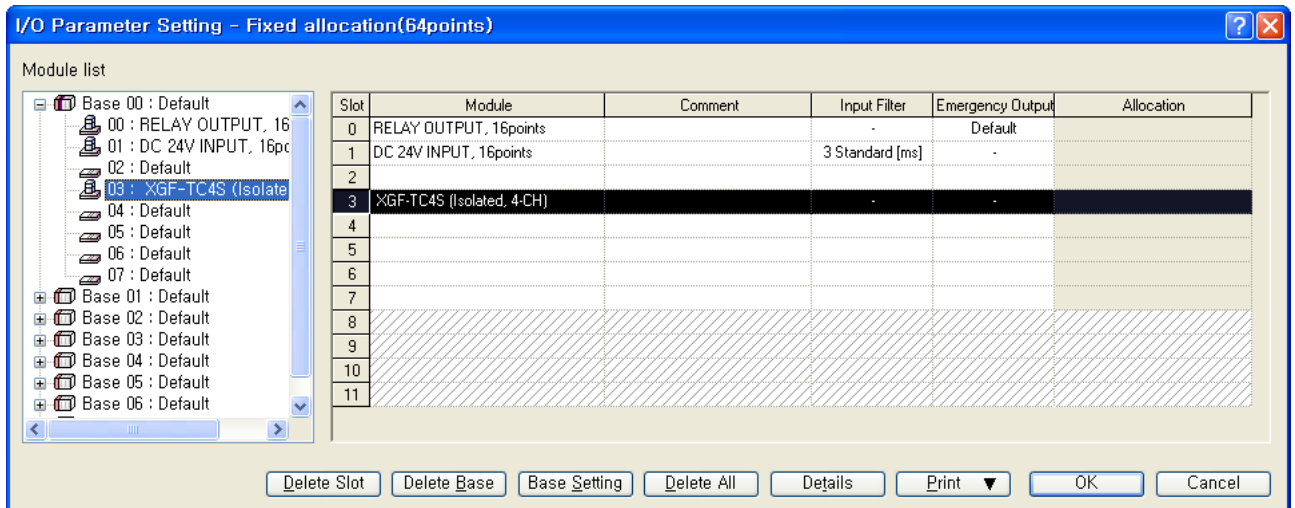

## Chapter 8 Programming (For XGI/XGR)

XGF-TC4S (Isolated, 4-CH)

Parameter	CH 0	CH 1	CH 2	CH 3
<input type="checkbox"/> Channel status	Enable	Enable	Disable	Disable
<input type="checkbox"/> Sensor status	K	K	K	K
<input type="checkbox"/> Temp. unit	Celsius	Celsius	Celsius	Celsius
Filter constant	0	0	0	0
<input type="checkbox"/> Average processing	Sampling	Sampling	Sampling	Sampling
Average value	0	0	0	0
<input type="checkbox"/> Scaling data type	Bipolar	Bipolar	Bipolar	Bipolar
Scaling min. value	-32768	-32768	-32768	-32768
Scaling max. value	32767	32767	32767	32767
Process alarm H.H.Limit	0	0	0	0
Process alarm H.Limit	0	0	0	0
Process alarm L.Limit	0	0	0	0
Process alarm L.L.Limit	0	0	0	0
Process alarm HYS	0	0	0	0
<input type="checkbox"/> RCA type	Change-Value	Change-Value	Change-Value	Change-Value
RCA high limit	0	0	0	0
RCA low limit	0	0	0	0
RCA period	40	40	40	40

OK Cancel

### 3) Program description

- If contact point (%IX0.1.0) of input module is on, it reads temperature of channel.
  - When temperature of CH0 is smaller than -20°C and larger than -30°C, output contact point (%QX0.0.0) is on.
  - When temperature of CH1 is smaller than 13°C and larger than 10°C, output contact point (%QX0.0.1) is on.
  - When temperature cap of CH0 and CH1 is larger than 5°C, output contact point (%QX0.0.2) is on.
  - TC4S is equipped at slot 3
  - K type sensor is used
  - Celsius is used as temperature unit
- Register module at slot where module is equipped and download operation parameter to PLC after setting operation parameter

# Chapter 8 Programming (For XGI/XGR)

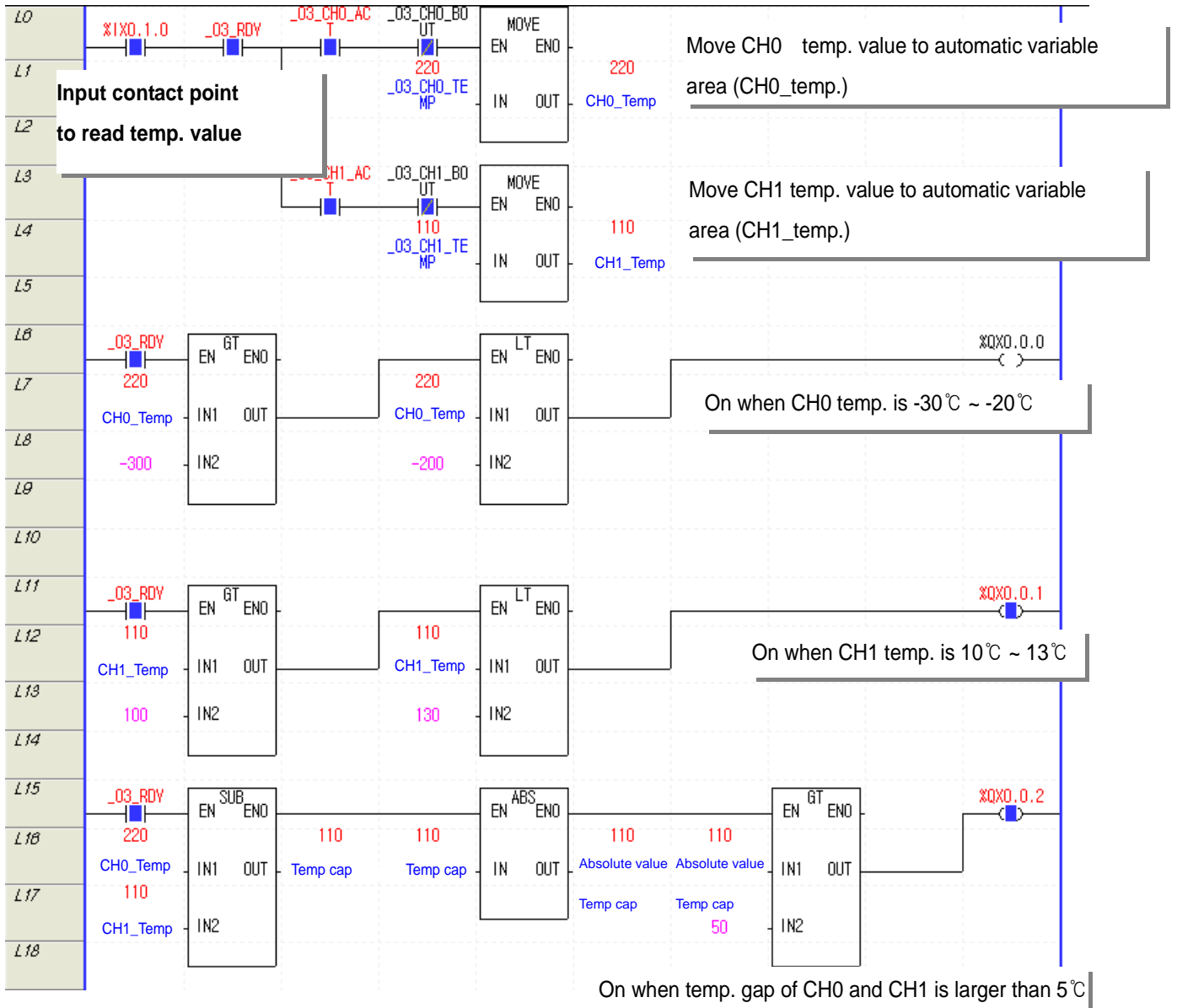

## 8.2.2 Program to monitor channel data

- Monitor temperature value when module is Ready status and channel is not disconnected
- Monitor min./max. value of temperature value when module is Ready status and channel is not disconnected

1) When monitoring at ladder program

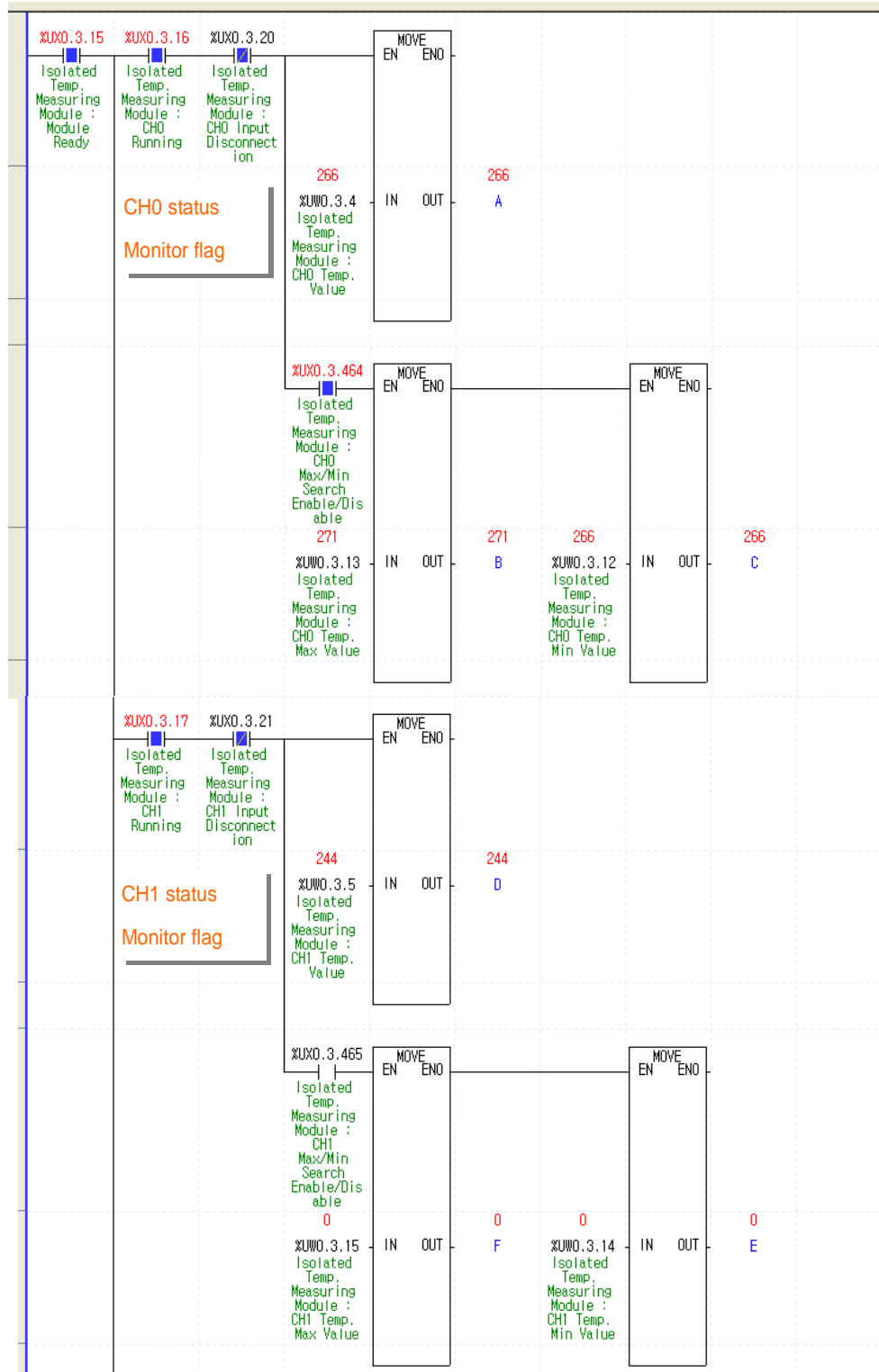

# Chapter 8 Programming (For XGI/XGR)

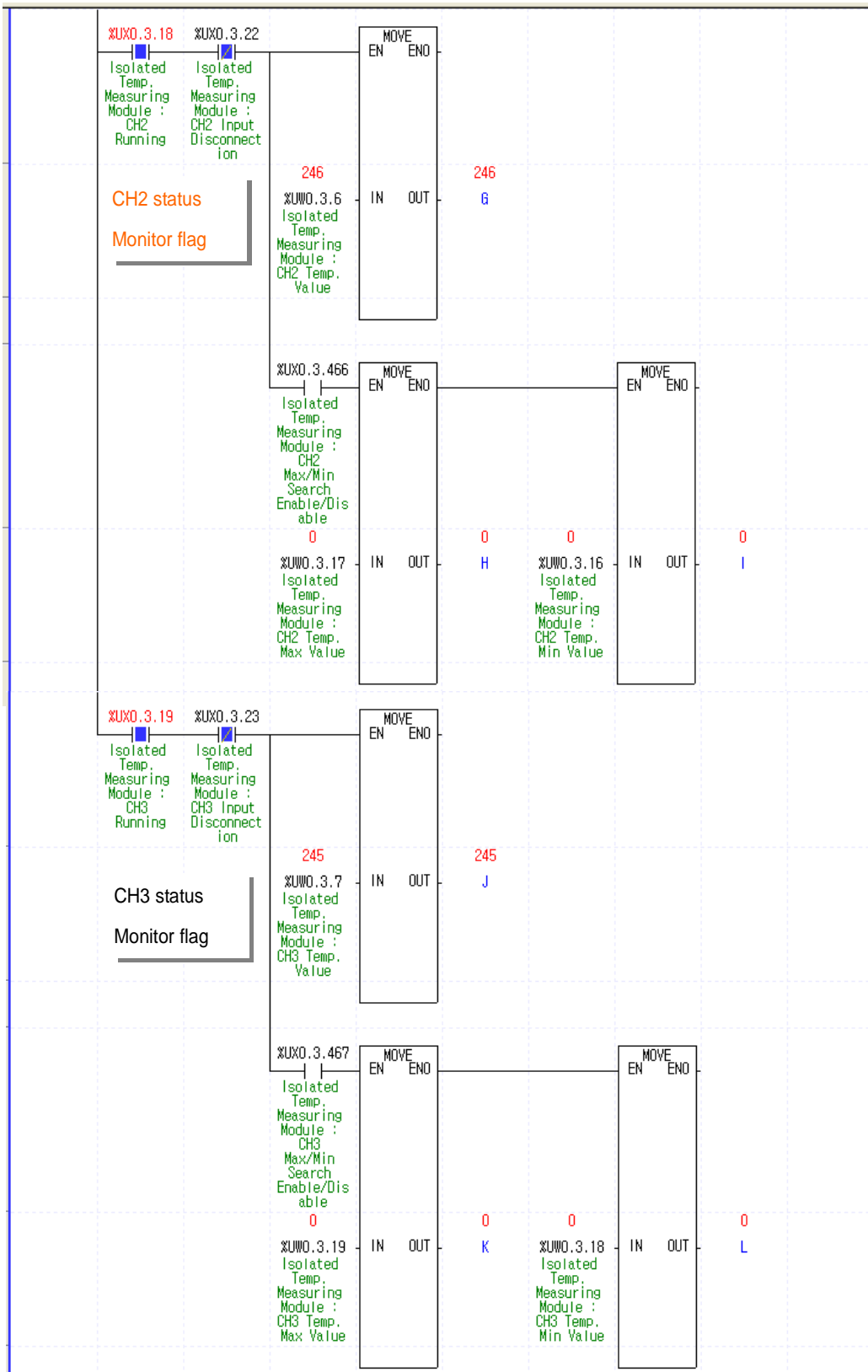

- : CH0,1,2 is running and CH3 has stopped
- : CH2 has been disconnected
- : CH0 and CH1 allowed to search max./min.

## Chapter 8 Programming (For XGI/XGR)

2) When monitoring by special monitor

**Special Module Monitor** [?] [X]

XGF-TC4S (Isolated, 4-CH)

Item	CH 0	CH 1
Temperature value	250	249
Scaling value	-21504	-21508
Min. temp value	246	0
Max. temp value	271	0
Input change(value/rate)	0	0
Item	CH 2	CH 3
Temperature value	251	250
Scaling value	-21500	-21504
Min. temp value	0	0
Max. temp value	0	0
Input change(value/rate)	0	0
FLAG Monitor	<input type="button" value="FLAG Monitor"/>	

Item	Setting value	Current value
CH 0		
Channel status	Disable	Enable
Sensor type	K	K
Temp. unit	Celsius	Celsius
Filter constant	0	0
Average processing	Sampling	Sampling
Average value	0	0
Scaling data type	Bipolar	Bipolar
Scaling min. value	-32768	-32768
Scaling max. value	32767	32767
Process alarm H.H.Limit	0	0
Process alarm H.Limit	0	0
Process alarm L.Limit	0	0
Process alarm L.Limit	0	0
Process alarm HYS	0	0
RCA type	Change-Value	Change-Value
RCA high limit	0	0
RCA low limit	0	0
RCA period	40	40

**Temp. Measuring Module Command** [?] [X]

XGF-TC4S (Isolated, 4-CH)

Item	CH 0	CH 1
Channel status	Run	Run
Sensor status	Normal	Normal
Process alarm(H.H.Limit)	OFF	OFF
Process alarm(H.Limit)	OFF	OFF
Process alarm(L.Limit)	OFF	OFF
Process alarm(L.L.Limit)	OFF	OFF
RCA high limit	OFF	OFF
RCA low limit	OFF	OFF
Item	CH 2	CH 3
Channel status	Run	Run
Sensor status	Normal	Normal
Process alarm(H.H.Limit)	OFF	OFF
Process alarm(H.Limit)	OFF	OFF
Process alarm(L.Limit)	OFF	OFF
Process alarm(L.L.Limit)	OFF	OFF
RCA high limit	OFF	OFF
RCA low limit	OFF	OFF

Command	CH 0	CH 1
Max/Min active	<input type="button" value="DISABLE"/>	<input type="button" value="DISABLE"/>
Alarm active	<input type="button" value="DISABLE"/>	<input type="button" value="DISABLE"/>
RJC Active	<input type="button" value="ENABLE"/>	<input type="button" value="ENABLE"/>
Command	CH 2	CH 3
Max/Min active	<input type="button" value="DISABLE"/>	<input type="button" value="DISABLE"/>
Alarm active	<input type="button" value="DISABLE"/>	<input type="button" value="DISABLE"/>
RJC Active	<input type="button" value="ENABLE"/>	<input type="button" value="ENABLE"/>

8.1.3 Other data monitor program

- Program monitoring temperature value and max./min. value of temperature value when module is Ready status and channel is not disconnected
- In case 3 channels are running, updated every 120[ms] (40ms/channel)



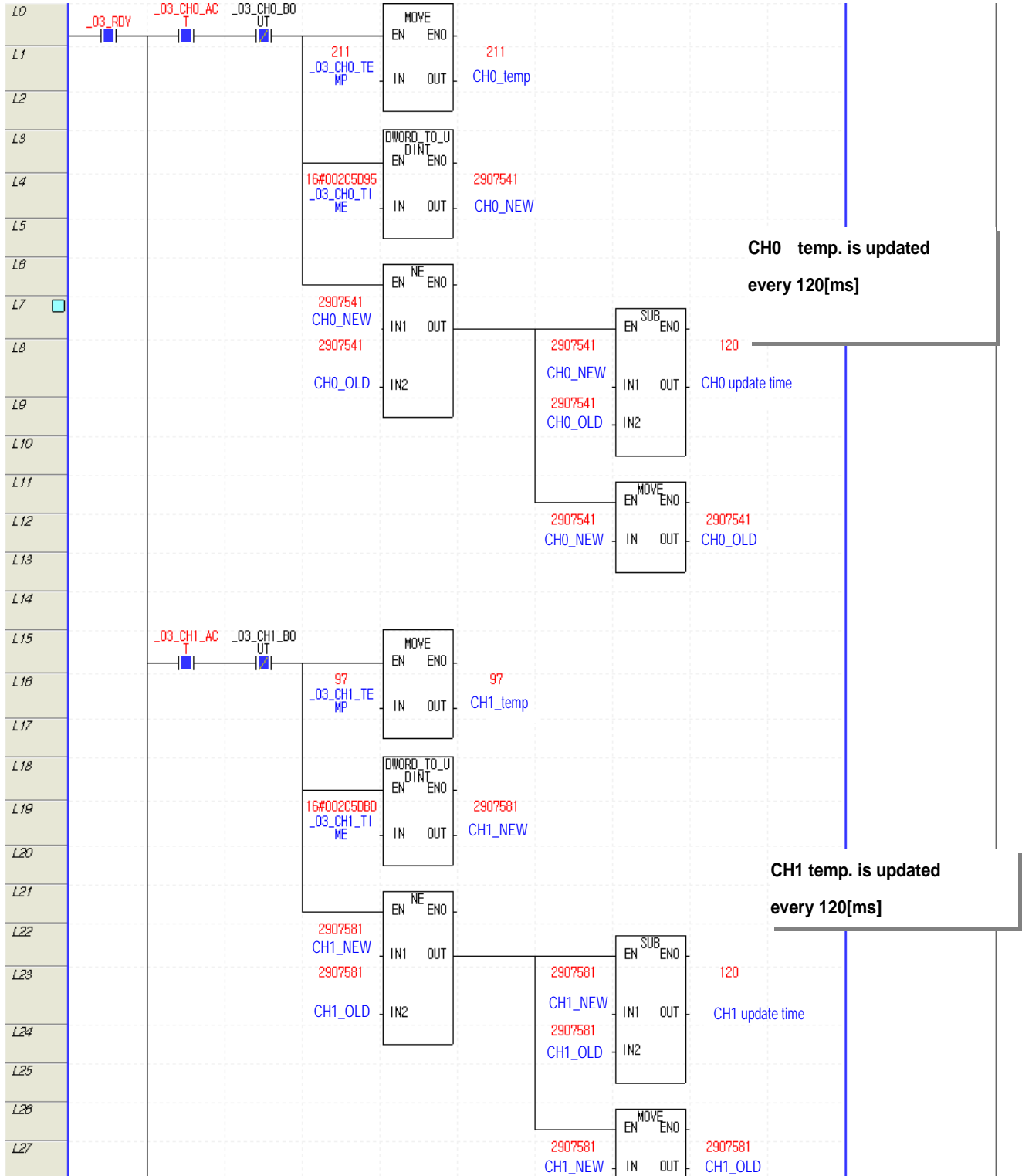

## Chapter 9 Troubleshooting

The chapter describes diagnostics and correctives measures in case any trouble occurs during use of XGF-TC4S.

### 9.1 LED Indication by Errors

XGF-TC4S has two LEDs and it is possible to check whether it had any error with the indication of RUN LED and ALM LED.

Item	Normal	Disconnection	Abnormal module H/W (error)	Module offset/gain backup error (memory checksum if powered on)
RUN LED	On	On	Flicker every 0.2 second	Flicker every 1 second
ALM LED	Off	Flicker every second	Off	Off
Operation	Normal operation Every function works	Normal operation Every function works	Module function stops	Normal operation Every function works
Management	-	-	Customer service	Try to power on again and if it still shows error, Customer service is needed

**9.2 Diagnostics and Measures**

**9.2.1 Run LED quickly flickers.**

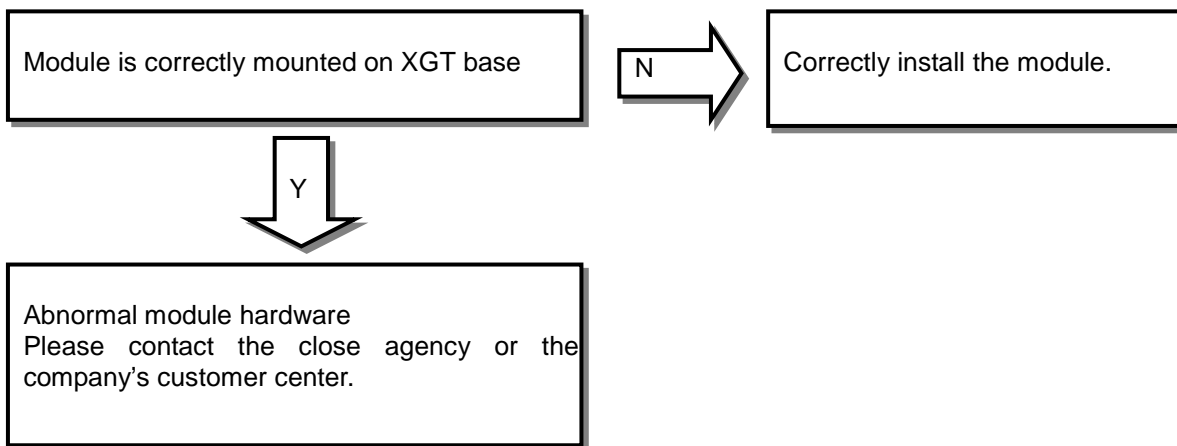

**9.2.2 Run LED slowly flickers.**

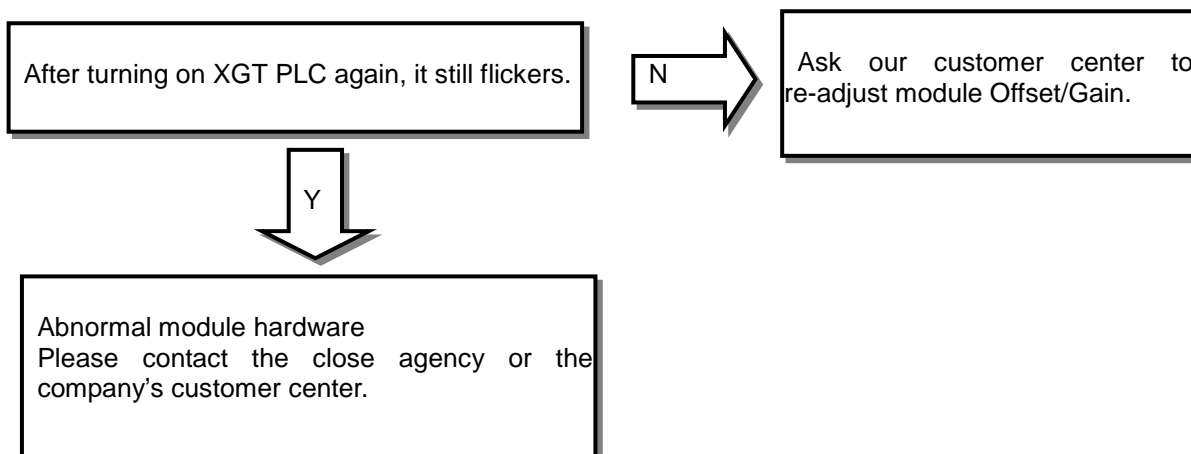

9.2.3 Run LED turns off

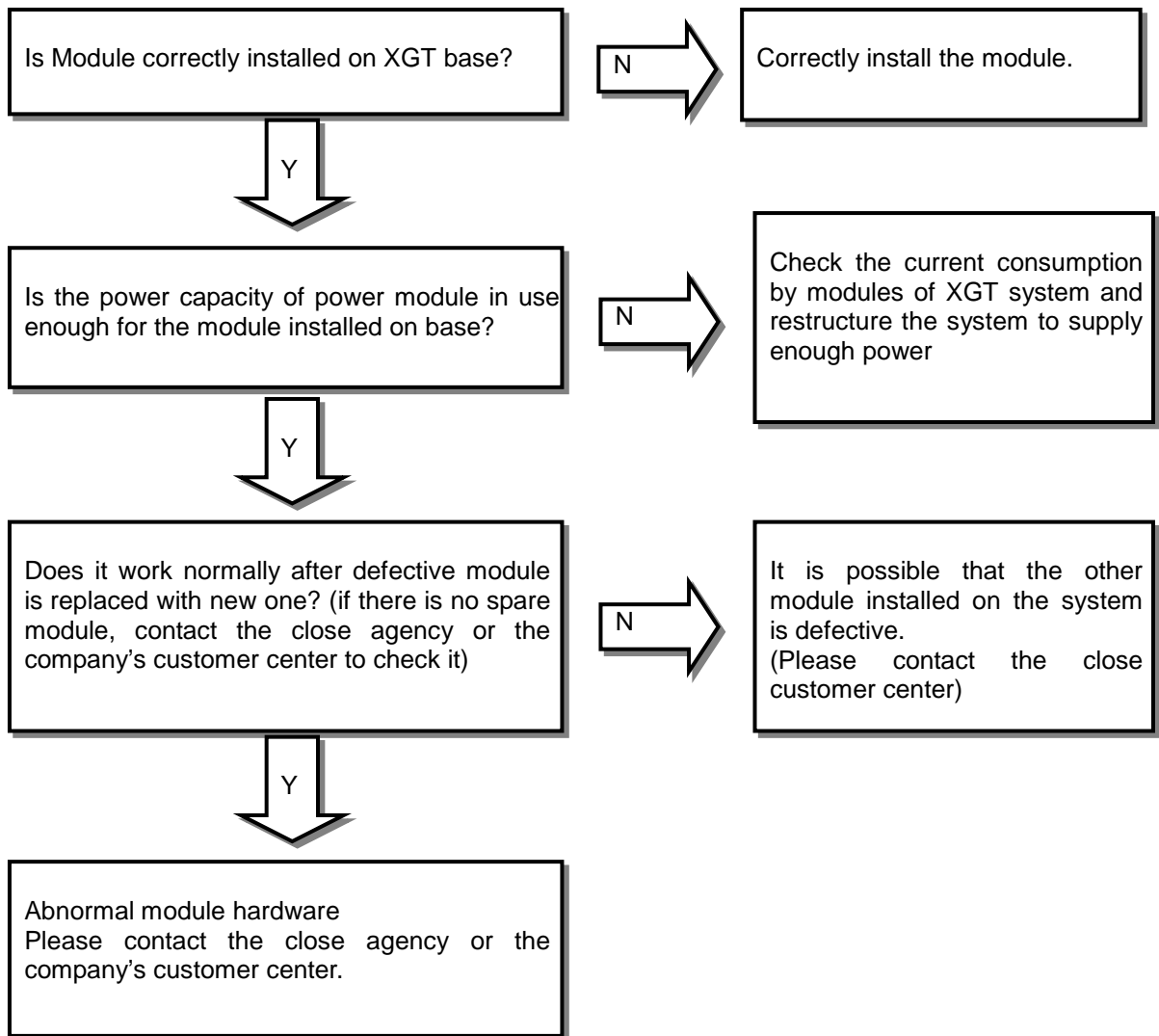

**9.2.4 ALM LED flickers.**

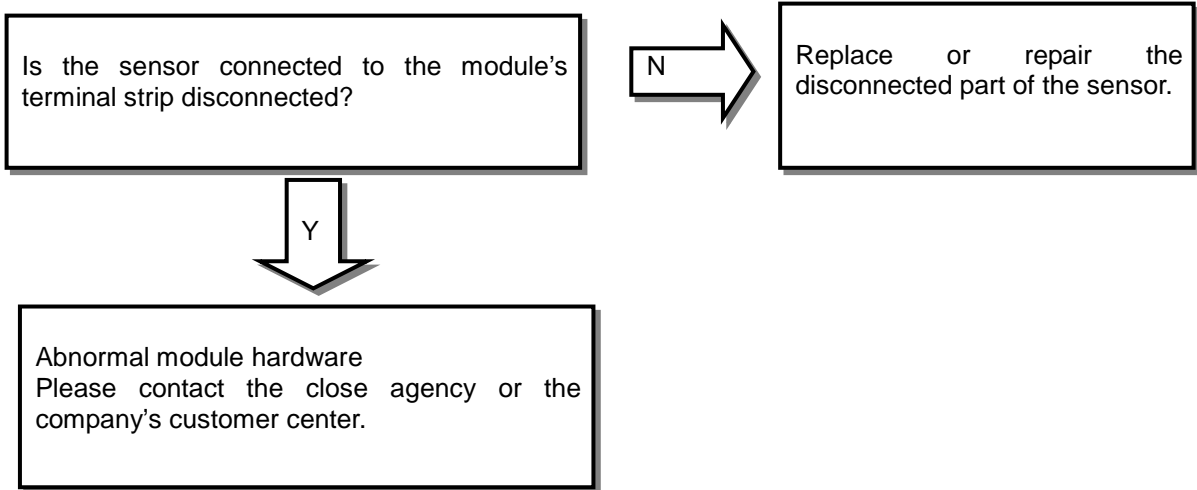

**9.2.5 CPU Module can not read temperature conversion value**

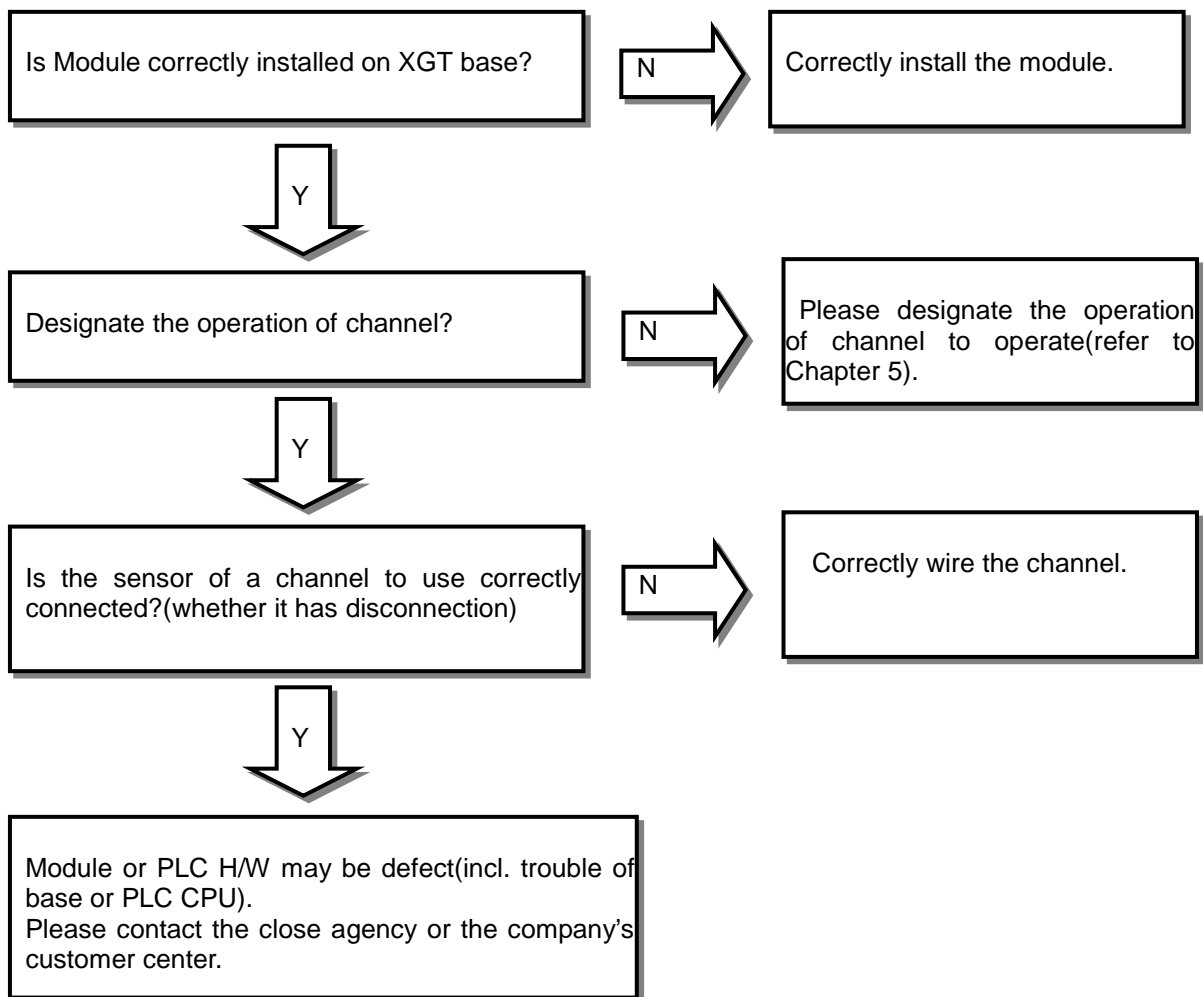

**9.3 Error Code**

**9.3.1 Error Codes of abnormal sensor connection  
(in case of sensor disconnection)**

Description	RUN LED status	ALM LED status	Junction (on)	Code PUT command(*1)	Class
Normal operation	On	Off	-	0	Normal
CH 0 thermocouple sensor disconnected	On	Flickers every second	Uxy.01.4	Address 68(h044) 1	Defective sensor
CH 0 cold junction sensor disconnected	On	Flickers every second	Uxy.01.4	Address 68(h044) 2	Defective sensor
CH 1 thermocouple sensor disconnected	On	Flickers every second	Uxy.01.5	Address 69(h045) 1	Defective sensor
CH 1 cold junction sensor disconnected	On	Flickers every second	Uxy.01.5	Address 69(h045) 2	Defective sensor
CH 2 thermocouple sensor disconnected	On	Flickers every second	Uxy.01.6	Address 70(h046) 1	Defective sensor
CH 2 cold junction sensor disconnected	On	Flickers every second	Uxy.01.6	Address 70(h046) 2	Defective sensor
CH 3 thermocouple sensor disconnected	On	Flickers every second	Uxy.01.7	Address 71(h047) 1	Defective sensor
CH 3 cold junction sensor disconnected	On	Flickers every second	Uxy.01.7	Address 71(h047) 2	Defective sensor

(\*1) For code info in case of disconnection, refer to the address.

**9.3.2 Error Codes of abnormal module H/W (contact the close agency or the company)**

Description	RUN LED status	ALM LED status	Junction (on)	Code(*2)	Class
EEPROM CHECKSUM ERROR	Flickers every second	Off	Uxy.00.D	Module error:40	Error
FACP_01 chip reset error	Flickers every 0.2 second	Off	Uxy.00.E	Module error:10	Error
FACP_01 internal RAM error	Flickers every 0.2 second	Off	Uxy.00.E	Module error:11	Error
FACP_01 internal register error	Flickers every 0.2 second	Off	Uxy.00.E	Module error:12	Error
REFERSH area writing error in module	Flickers every 0.2 second	Off	Uxy.00.E	Module error:30	Error
FRESH area reading error in module	Flickers every 0.2 second	Off	Uxy.00.E	Module error:32	Error
AD conversion H/W error	Flickers every 0.2 second	Off	Uxy.00.E	Module error:2x(*3)	Error

## Chapter 9 Troubleshooting

---

(\*2) Module H/W trouble info is displayed in module OS info window (for information on module OS, refer to Chapter 4)

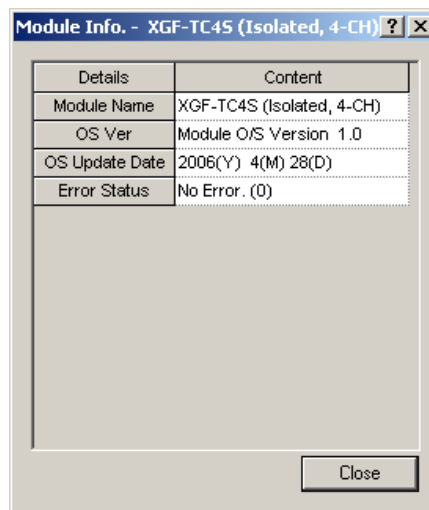

(\*3) In 2x, 'x' represents the no. of channel with AD conversion H/W error. The module, as inter-channel insulation module, has H/W converting analog to digital, which independently operates.

### Appendix 1 Terminology

Terms and abbreviation used in this user's manual and the analog module in general are as described below.

- A/D converter: converts analog to digital value proportionately to the size of analog input signal.
- Analog input module: as a module with the circuit to convert analog voltage/current input signal to digital value, it has resolution of 14 and 16 bits according to converters.
- Channel: related with the terminal of analog I/O module and connected to various voltage/current I/O devices respectively, with applicable data and diagnosis function as well.
- Conversion time: time necessary for analog input module to sample and convert the analog signal for the processor inside the module to get digital-converted value input. On the other hand, it is time necessary for analog output module to convert the digital value output from the processor inside the module to analog output signal so to transmit to the output channel.
- D/A converter: related with the output module, it is used to make continuous size of analog voltage and current signal proportionately to the digital value.
- Full scale: defined as the size of voltage/current where the normal operation is executed.
- Full scale error: displayed with graph difference between agreeable analog-converted value and actual analog-converted value.
- Full scale range: displayed with difference between the maximum and the minimum of the analog input.
- LSB (Least Significant Bit): displays the minimum value of the bit unit.

## Appendix 1 Terminology

---

- Linearity error: analog I/O is related between continuous voltage/current value and digital value, whose agreeable I/O value is defined as a line within a distance of the minimum 1LSB of voltage/current. I/O linearity error is regarded as the declination between the agreeable-converted value and the actual-converted value on the graph.

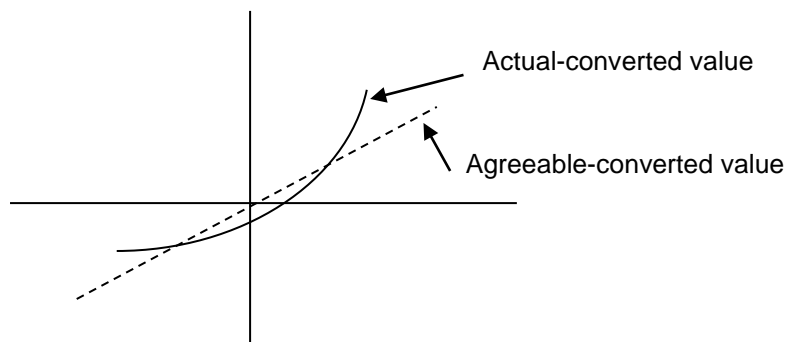

- Multiplexer: a switching circuit where many signals share one A/D converter or D/A converter.
- Analog output module: a module with output circuit to convert analog DC voltage or current signal proportionate to digital value delivered to the module from the processor.
- Resolution: the minimum value recognizable by a measuring instrument, which is usually displayed in the engineering unit (1mv) or the number of bits. In other words, 16383 types of output are available for 14 bits.
- Filter: used to reduce the change of the digital-converted output value by sudden change of the external noise or input for the analog circuit, through two methods of Software and Hardware filters.
- Accuracy: displayed with the maximum declination between agreeable value and output voltage or current for the whole range of output. On the other hand, it is displayed with the maximum declination between agreeable value and digital-converted input signal value for the whole range of input. Generally, percentage will be displayed for the full scale.  
Gain, Offset and Linearity error are all included in the error type available.
- Output accuracy: displayed with the difference between the actual analog output voltage/current value and the agreeable-converted value on the conversion graph for the full scale, with Offset, Gain and Drift error factors included as well as normal temperature (25°C) and available temperature range displayed respectively.



## Appendix 2 Thermo Electromotive Force and Compensating Cable

### 1.1 Table of Thermo Electromotive Force

▶ Type K

unit :  $\mu\text{V}$

-200	-100	-0	Temp. (°C)	Temp. (°C)	0	100	200	300	400	500	600	700	800	900	1000	1100	1200
-5891	-3553	-0	-0	0	0	4095	8137	12207	16395	20640	24902	29128	33277	37325	41269	45108	48828
	-3852	-392	-10	10	397	4508	8537	12623	16818	21066	25327	29547	33686	37724	41657	45486	
	-4138	-777	-20	20	798	4919	8938	13039	17241	21493	25751	29965	34095	38122	42045	45863	
	-4410	-1156	-30	30	1203	5327	9341	13456	17664	21919	26176	30383	34502	38519	42432	46238	
	-4669	-1527	-40	40	1611	5733	9745	13874	18088	22346	26599	30799	34909	38915	42817	46612	
	-4912	-1889	-50	50	2022	6137	10151	14292	18513	22772	27022	31214	35314	39310	43202	46985	
	-5141	-2243	-60	60	2436	6539	10560	14712	18938	23198	27445	31629	35718	39703	43585	47356	
	-5354	-2586	-70	70	2850	6939	10969	15132	19363	23624	27867	32042	36121	40096	43968	47726	
	-5550	-2920	-80	80	3266	7338	11381	15552	19788	24050	28288	32455	36524	40488	44349	48095	
	-5730	-3242	-90	90	3681	7737	11793	15974	20214	24476	28709	32866	36925	40879	44729	48462	

▶ Thermo electromotive force based on Type J

-200	-100	-0	Temp. (°C)	Temp. (°C)	0	100	200	300	400	500	600	700	800
-7890	-4632	0	-0	0	0	5268	10777	16325	21846	27388	33096	39130	45498
	-5036	-501	-10	10	507	5812	11332	16879	22397	27949	33683	39754	
	-5426	-995	-20	20	1019	6359	11887	17432	22949	28511	34273	40382	
	-5801	-1481	-30	30	1536	6907	12442	17984	23501	29075	34867	41013	
	-6159	-1960	-40	40	2058	7457	12998	18537	24054	29642	35464	41647	
	-6499	-2431	-50	50	2585	8008	13553	19089	24607	30210	36066	42283	
	-6821	-2892	-60	60	3115	8560	14108	19640	25161	30782	36671	42922	
	-7122	-3344	-70	70	3649	9113	14663	20192	25716	31356	37280	43563	
	-7402	-3785	-80	80	4186	9667	15217	20743	26272	31933	37893	44207	
	-7659	-4215	-90	90	4725	10222	15771	21295	26829	32513	38510	44852	

## Appendix 2 Thermo Electromotive Force and Compensating Cable

► Thermo electromotive force based on type E

unit :  $\mu\text{V}$

-200	-100	-0	Temp. (°C)	Temp. (°C)	0	100	200	300	400	500	600
-8824	-5237	0	-0	0	0	6317	13419	21033	28943	36999	45085
	-5680	-581	-10	10	591	6996	14161	21814	29744	37808	
	-6107	-1151	-20	20	1192	7683	14909	22597	30546	38617	
	-6516	-1709	-30	30	1801	8377	15661	23383	31350	39426	
	-6907	-2254	-40	40	2419	9078	16417	24171	32155	40236	
	-7279	-2787	-50	50	3047	9787	17178	24961	32960	41045	
	-7631	-3306	-60	60	3683	10501	17942	25754	33767	41853	
	-7963	-3811	-70	70	4329	11222	18710	26549	34574	42662	
	-8273	-4301	-80	80	4983	11949	19481	27345	35382	43470	
	-8561	-4777	-90	90	5646	12681	20256	28143	36190	44278	

► Thermo electromotive force based on type T

-200	-100	-0	Temp. (°C)	Temp. (°C)	0	100	200	300	400
-5603	-3378	0	-0	0	0	4277	9286	14860	20869
	-3656	-383	-10	10	391	4749	9820	15443	
	-3923	-757	-20	20	789	5227	10360	16030	
	-4177	-1121	-30	30	1196	5712	10905	16621	
	-4419	-1475	-40	40	1611	6204	11456	17217	
	-4648	-1819	-50	50	2035	6702	12011	17816	
	-4865	-2152	-60	60	2467	7207	12572	18420	
	-5069	-2475	-70	70	2908	7718	13137	19027	
	-5261	-2788	-80	80	3357	8235	13707	19638	
	-5439	-3089	-90	90	3813	8757	14281	20252	

## Appendix 2 Thermo Electromotive Force and Compensating Cable

► Thermo electromotive force based on type B

unit :  $\mu\text{V}$

( $^{\circ}\text{C}$ )	400	500	600	700	800	900	1000	1100	1200	1300	1400	1500	1600	1700	1800
0	786	1241	1791	2430	3154	3957	4833	5777	6783	7845	8952	10094	11257	12426	13585
10	827	1292	1851	2499	3231	4041	4924	5875	6887	7953	9065	10210	11374	12543	
20	870	1344	1912	2569	3308	4126	5016	5973	6991	8063	9178	10325	11491	12659	
30	913	1397	1974	2639	3387	4212	5109	6073	7096	8172	9291	10441	11608	12776	
40	957	1450	2036	2710	3466	4298	5202	6172	7202	8283	9405	10558	11725	12892	
50	1002	1505	2100	2782	3546	4386	5297	6273	7308	8393	9519	10674	11842	13008	
60	1048	1560	2164	2855	3626	4474	5391	6374	7414	8504	9634	10790	11959	13124	
70	1095	1617	2230	2928	3708	4562	5487	6475	7521	8616	9748	10907	12076	13239	
80	1143	1674	2296	3003	3790	4652	5583	6577	7628	8727	9863	11024	12193	13354	
90	1192	1732	2363	3078	3873	4742	5680	6680	7736	8839	9979	11141	12310	13470	

► Thermo electromotive force based on type R

unit :  $\mu\text{V}$

( $^{\circ}\text{C}$ )	0	100	200	300	400	500	600	700	800	900	1000	1100	1200	1300	1400	1500	1600	1700
0	0	647	1468	2400	3407	4471	5582	6741	7949	9203	10503	11846	13224	14624	16035	17445	18842	20215
10	54	723	1557	2498	3511	4580	5696	6860	8072	9331	10636	11983	13363	14765	16176	17585	18981	20350
20	111	800	1647	2596	3616	4689	5810	6979	8196	9460	10768	12119	13502	14906	16317	17726	19119	20483
30	171	879	1738	2695	3721	4799	5925	7098	8320	9589	10902	12257	13642	15047	16458	17866	19257	20616
40	232	959	1830	2795	3826	4910	6040	7218	8445	9718	11035	12394	13782	15188	16599	18006	19395	20748
50	296	1041	1923	2896	3933	5021	6155	7339	8570	9848	11170	12532	13922	15329	16741	18146	19533	20878
60	363	1124	2017	2997	4039	5132	6272	7460	8696	9978	11304	12669	14062	15470	16882	18286	19670	21006
70	431	1208	2111	3099	4146	5244	6388	7582	8822	10109	11439	12808	14202	15611	17022	18425	19807	
80	501	1294	2207	3201	4254	5356	6505	7704	8949	10240	11574	12946	14343	15752	17163	18564	19944	
90	573	1380	2303	3304	4362	5469	6623	7826	9076	10371	11710	13085	14483	15893	17304	18703	20080	

## Appendix 2 Thermo Electromotive Force and Compensating Cable

► Thermo electromotive force based on type S

unit :  $\mu\text{v}$

( $t_c$ )	0	100	200	300	400	500	600	700	800	900	1000	1100	1200	1300	1400	1500	1600	1700
0	0	645	1440	2323	3260	4234	5237	6274	7345	8448	9598	10754	11947	13155	14368	15576	16771	17942
10	55	719	1525	2414	3356	4333	5339	6380	7454	8560	9700	10872	12067	13276	14489	15697	16890	18056
20	113	795	1611	2506	3452	4432	5442	6486	7563	8673	9816	10991	12188	13397	14610	15817	17008	18170
30	173	872	1698	2599	3549	4532	5544	6592	7672	8786	9932	11110	12308	13519	14731	15937	17125	18282
40	235	950	1785	2692	3645	4632	5648	6699	7782	8899	10048	11229	12429	13640	14852	16057	17243	18394
50	299	1029	1873	2786	3743	4732	5751	6805	7892	9012	10165	11348	12550	13761	14973	16176	17360	18504
60	365	1109	1962	2880	3840	4832	5855	6913	8003	9126	10282	11467	12671	13883	15094	16296	17477	18612
70	432	1190	2051	2974	3938	4933	5960	7020	8114	9240	10400	11587	12792	14004	15215	16415	17594	
80	502	1273	2141	3069	4036	5034	6064	7128	8225	9355	10517	11707	12913	14215	15336	16534	17711	
90	573	1356	2232	3164	4135	5136	6169	7236	8336	9470	10635	11827	13034	14247	15456	16653	17826	

**1.2 Thermocouple**

**1.2.1 Common limit and overheat limit**

Symbol of materials	Former symbols (cf)	Nominal diameter (mm)	Common limit (1) °C	Overheat limit (2) °C
B	–	0.50	1500	1700
R	–	0.50	1400	1600
S				
K	CA	0.65	650	850
		1.00	750	950
		1.60	850	1050
		2.30	900	1100
		3.20	1000	1200
E	CRC	0.65	450	500
		1.00	500	550
		1.60	550	650
		2.30	600	750
		3.20	700	800
J	IC	0.65	400	500
		1.00	450	550
		1.60	500	650
		2.30	550	750
		3.20	600	750
T	CC	0.32	200	250
		0.65	200	250
		1.00	250	300
		1.60	300	300

**Remarks**

(1): common limit refers to the temperature limit that continuously use in the air.  
 (2): overheat limit refers to the temperature limit that may inevitably use for a short time.

## Appendix 2 Thermo Electromotive Force and Compensating Cable

### 1.2.2 Allowance by temperature

Symbol of materials	Former symbols (cf)	Temperature	Grade	Allowance
B	–	600°C ~ lower than 1700°C	0.5	±4°C or ± 0.5% of temperature measured
R	–	0°C ~ lower than 1600°C	0.25	±1.5°C or ±0.25% of temperature measured
S				
K	CA	0 °C ~ lower than 1000°C	0.4	±1.5°C or ±0.4% of temperature measured
		0°C ~ lower than 1200°C	0.75	±2.5°C or ±0.75% of temperature measured
		-200°C~ lower than 0°C	1.5	±2.5°C or ±1.5% of temperature measured
E	CRC	0°C~ lower than 800°C	0.4	±1.5°C or ±0.4% of temperature measured
		0°C~ lower than 800°C	0.75	±2.5°C or ±0.75% of temperature measured
		-200 °C~ lower than 0°C	1.5	±2.5°C or ±1.5% of temperature measured
J	IC	0°C~ lower than 750°C	0.4	±1.5 °C or ±0.4% of temperature measured
		0°C~ lower than 750°C	0.75	±2.5°C or ±0.75% of temperature measured
T	CC	0°C~ lower than 350°C	0.4	±0.5°C or ±0.4% of temperature measured
		0°C~ lower than 350°C	0.75	±1°C or ±0.75% of temperature measured
		-200°C~ lower than 0°C	1.5	±1°C or ± 1.5% of temperature measured

#### Remark

Allowance refers to the allowable max. limit subtracting the actual temperature of junction from the converted temperature, based on thermo electromotive force table. In addition, the allowance will be bigger one of °C or %.

## Appendix 2 Thermo Electromotive Force and Compensating Cable

### 1.3 Compensating Cable

#### 1.3.1 Type and specifications of compensating cable

Type of compound thermocouple		Type of compensating type		Sectional ratio by application and allowance	Materials		Operating temp. range (°C)	Temp. of thermo. and junction (°C)	Electric resistance of compensating cable (Ω) <sup>(3)</sup>	Electric resistance of return cable (Ω) <sup>(3)</sup>	Sheath colors	Core cable color		Remarks	
Symbol	Former symbol	symbol	Former symbol		+ point	- point						+	-		
B	-	BX-G	-	Common for general use	Copper	Copper	0-90	0-100	- <sup>(1)</sup>	0.05	Grey	Red	White	Compensation type	
R	-	RX-G	-	Common for general use	Copper	Alloy of copper and nickel	0-90	0-150	+3 <sup>(2)</sup>	0.1	Black	Red	White		
S		RX-H		SX-H			Common for heat-resistance		0-150						-7
K	CA	KX-G	WCA-G	Common for general use	Alloy of nickel and chrome	Alloy of nickel	-20-90	-20-150	±2.5	1.5	Blue	Red	White	Expansion type	
		KX-GS	WCA-GS	Common for general use					±1.5						
		KX-H	WCA-H	Common for heat-resistance			±2.5								
		KX-HS	WCA-HS	Common for heat-resistance			±1.5								
		WX-G	WCA-G	Common for general use	Iron	Alloy of copper and nickel	-20-90		±3.0	0.5				Compensation type	
		WX-H	WCA-H	Common for heat-resistance			0-150								
		VX-G	WCA-G	Common for general use	Copper	Alloy of copper and nickel	-20-90		-20-100	0.8					
E	CRC	EX-G	WCRC-G	Common for general use	Alloy of chrome and nickel	Alloy of copper and nickel	-20-90	-20-150	±2.5	1.5	Purple	Red	White	Expansion type	
		EX-H	WCRC-H	Common for heat-resistance			0-150								
J	IC	JX-G	WIC-G	Common for general use	Iron	Alloy of copper and nickel	-20-90		0-150	0.8	Yellow	Red	White		
		JX-H	WIC-H	Common for heat-resistance											
T	CC	TX-G	WCC-C	Common for general use	Copper	Alloy of copper and nickel	-20-90		0-150	±2.0	0.8	Brown	Red		White
		TX-GS	-	Precise for general use						±1.0					
		TX-H	WCC-H	Common for heat-resistance			±2.0								
		TX-HS	-	Precise for heat-resistance			±1.0								

#### Remark

- (1): BX-G uses same copper to + point and - points, so the allowance is not described.  
(2): The thermocouple electromotive force of thermocouple R and S is non-linear, so it does not indicate the actual temperature measurement error.  
(3): applicable to nominal cross-sectional area of 1.25mm<sup>2</sup> and more.





# Appendix 3 Dimension

## Appendix 3 Dimension

### Appendix 3.1 XGF-TC4S

unit: mm

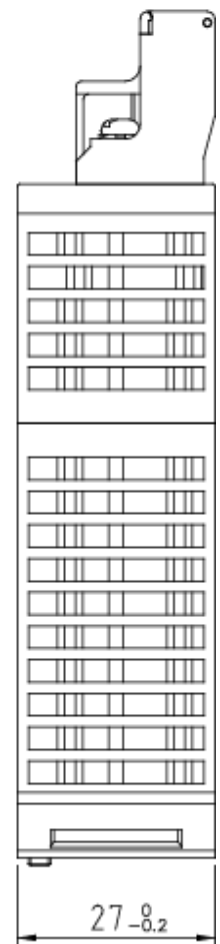
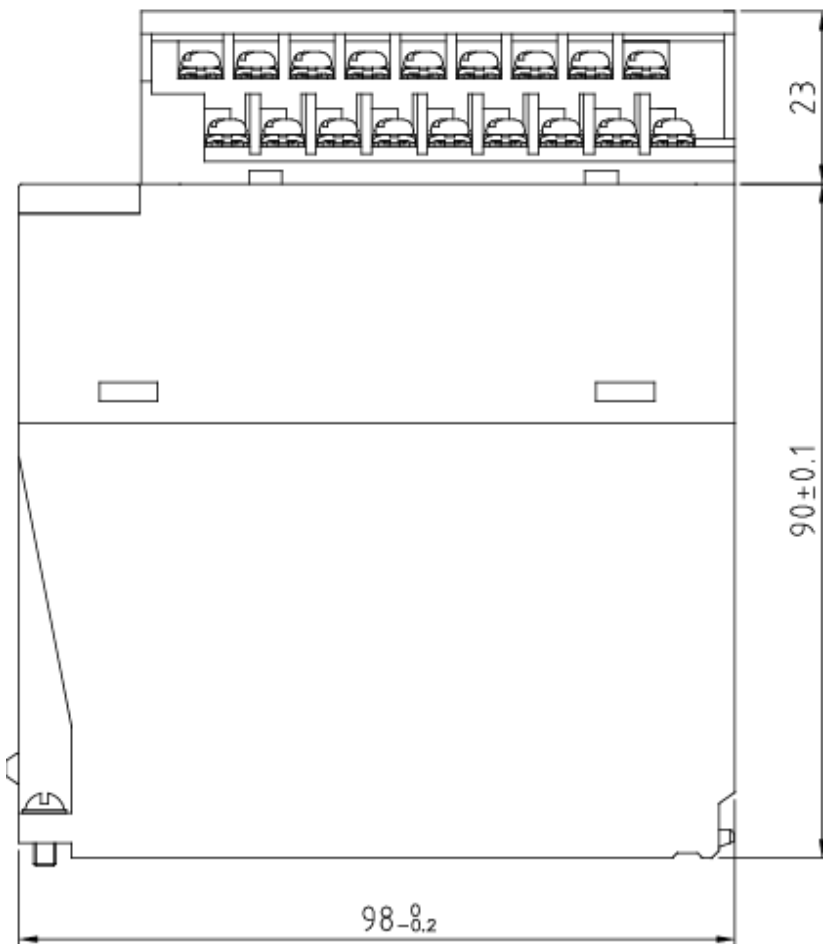
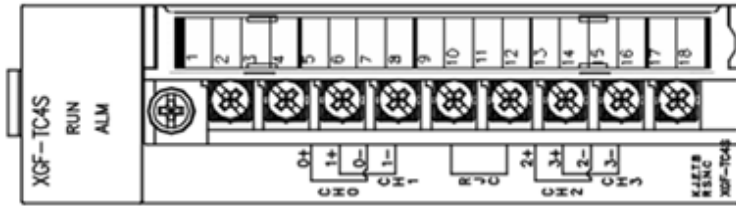



## Warranty

### 1. Warranty Period

The product you purchased is guaranteed for 36 months from the date of manufacture.

### 2. Scope of Warranty

- (1) The initial diagnosis of faults is basically conducted by your company. However, upon your request, our company or our service network can undertake this task for a fee. If the cause of the fault lies with our company, this service will be provided free of charge.
- (2) This warranty only applies if the product is used under normal conditions according to the specifications and precautions described in the handling instructions, user manuals, catalogs, and caution labels.
- (3) Even within the free warranty period, the following cases will be subject to paid repairs:
  - 1) Replacement of consumable and life-limited parts (e.g., relays, fuses, electrolytic capacitors, fans, LCDs, batteries, etc.)
  - 2) Failures or damages caused by improper storage, handling, negligence, or accidents by the customer
  - 3) Failures resulting from the customer's hardware or software design
  - 4) Failures due to modifications without our consent  
(Repairs will be refused, even for a fee, if recognized as modified or repaired outside our company)
  - 5) Failures that could have been avoided if the customer's equipment, in which our product is incorporated, had safety devices required by legal regulations or common industry standards
  - 6) Failures that could have been prevented if maintenance and replacement of consumable parts were performed normally according to the handling instructions or user manuals
  - 7) Failures and damages to the product caused by using connected equipment or inappropriate consumables
  - 8) Failures caused by external factors such as fire, abnormal voltage, force majeure, and natural disasters such as earthquakes, lightning, salt damage, wind, and flood damage
  - 9) Failures due to reasons that could not be predicted with the scientific and technical standards at the time of our shipment
  - 10) Other failures, damages, or defects recognized as the responsibility of your company

## Environmental Policy

LS ELECTRIC Co., Ltd supports and observes the environmental policy as below.

### Environmental Management

LS ELECTRIC considers the environmental preservation as the preferential management subject and every staff of LS ELECTRIC use the reasonable endeavors for the pleasurable environmental preservation of the earth.

### About disposal of the Product.

LS ELECTRIC' PLC unit is designed to protect the environment. For the disposal, separate aluminum, iron and synthetic resin (cover) from the product as they are reusable.





[www.ls-electric.com](http://www.ls-electric.com)

## LS ELECTRIC Co., Ltd.

### ■ Headquarter

LS-ro 127(Hogye-dong) Dongan-gu, Anyang-si, Gyeonggi-Do, 14119, Korea

### ■ Seoul Office

LS Yongsan Tower, 92, Hangang-daero, Yongsan-gu, Seoul, 04386, Korea

Tel: 82-2-2034-4033, 4888, 4703 Fax: 82-2-2034-4588

E-mail: [automation@ls-electric.com](mailto:automation@ls-electric.com)

### ■ Overseas Subsidiaries

• LS ELECTRIC Japan Co., Ltd. (Tokyo, Japan)

Tel: 81-3-6268-8241 E-Mail: [japan@ls-electric.com](mailto:japan@ls-electric.com)

• LS ELECTRIC (Dalian) Co., Ltd. (Dalian, China)

Tel: 86-411-8730-6495 E-Mail: [china.dalian@lselectric.com.cn](mailto:china.dalian@lselectric.com.cn)

• LS ELECTRIC (Wuxi) Co., Ltd. (Wuxi, China)

Tel: 86-510-6851-6666 E-Mail: [china.wuxi@lselectric.com.cn](mailto:china.wuxi@lselectric.com.cn)

• LS ELECTRIC Middle East FZE (Dubai, U.A.E.)

Tel: 971-4-886-5360 E-Mail: [middleeast@ls-electric.com](mailto:middleeast@ls-electric.com)

• LS ELECTRIC Europe B.V. (Hoofddorp, Netherlands)

Tel: 31-20-654-1424 E-Mail: [europartner@ls-electric.com](mailto:europartner@ls-electric.com)

• LS ELECTRIC America Inc. (Chicago, USA)

Tel: 1-800-891-2941 E-Mail: [sales.us@lselectricamerica.com](mailto:sales.us@lselectricamerica.com)

• LS ELECTRIC Turkey Co., Ltd.

Tel: 90-212-806-1225 E-Mail: [turkey@ls-electric.com](mailto:turkey@ls-electric.com)

### ■ Overseas Branches

• LS ELECTRIC Tokyo Office (Japan)

Tel: 81-3-6268-8241 E-Mail: [tokyo@ls-electric.com](mailto:tokyo@ls-electric.com)

• LS ELECTRIC Beijing Office (China)

Tel: 86-10-5095-1631 E-Mail: [china.auto@lselectric.com.cn](mailto:china.auto@lselectric.com.cn)

• LS ELECTRIC Shanghai Office (China)

Tel: 86-21-5237-9977 E-Mail: [china.auto@lselectric.com.cn](mailto:china.auto@lselectric.com.cn)

• LS ELECTRIC Guangzhou Office (China)

Tel: 86-20-3818-2883 E-Mail: [china.auto@lselectric.com.cn](mailto:china.auto@lselectric.com.cn)

• LS ELECTRIC Chengdu Office (China)

Tel: 86-28-8670-3201 E-Mail: [china.auto@lselectric.com.cn](mailto:china.auto@lselectric.com.cn)

• LS ELECTRIC Qingdao Office (China)

Tel: 86-532-8501-2065 E-Mail: [china.auto@lselectric.com.cn](mailto:china.auto@lselectric.com.cn)

• LS ELECTRIC Nanjing Office (China)

Tel: 86-25-8467-0005 E-Mail: [china.auto@lselectric.com.cn](mailto:china.auto@lselectric.com.cn)

• LS ELECTRIC Bangkok Office (Thailand)

Tel: 66-90-950-9683 E-Mail: [thailand@ls-electric.com](mailto:thailand@ls-electric.com)

• LS ELECTRIC Jakarta Office (Indonesia)

Tel: 62-21-2933-7614 E-Mail: [indonesia@ls-electric.com](mailto:indonesia@ls-electric.com)

• LS ELECTRIC Moscow Office (Russia)

Tel: 7-499-682-6130 E-Mail: [info@lselectric-ru.com](mailto:info@lselectric-ru.com)

• LS ELECTRIC America Western Office (Irvine, USA)

Tel: 1-949-333-3140 E-Mail: [america@ls-electric.com](mailto:america@ls-electric.com)

### Disclaimer of Liability

LS ELECTRIC has reviewed the information in this publication to ensure consistency with the hardware and software described. However, LS ELECTRIC cannot guarantee full consistency, nor be responsible for any damages or compensation, since variance cannot be precluded entirely. Please check again the version of this publication before you use the product.

© LS ELECTRIC Co., Ltd 2006 All Right Reserved.

2025.08